

[WORKING RANGE]

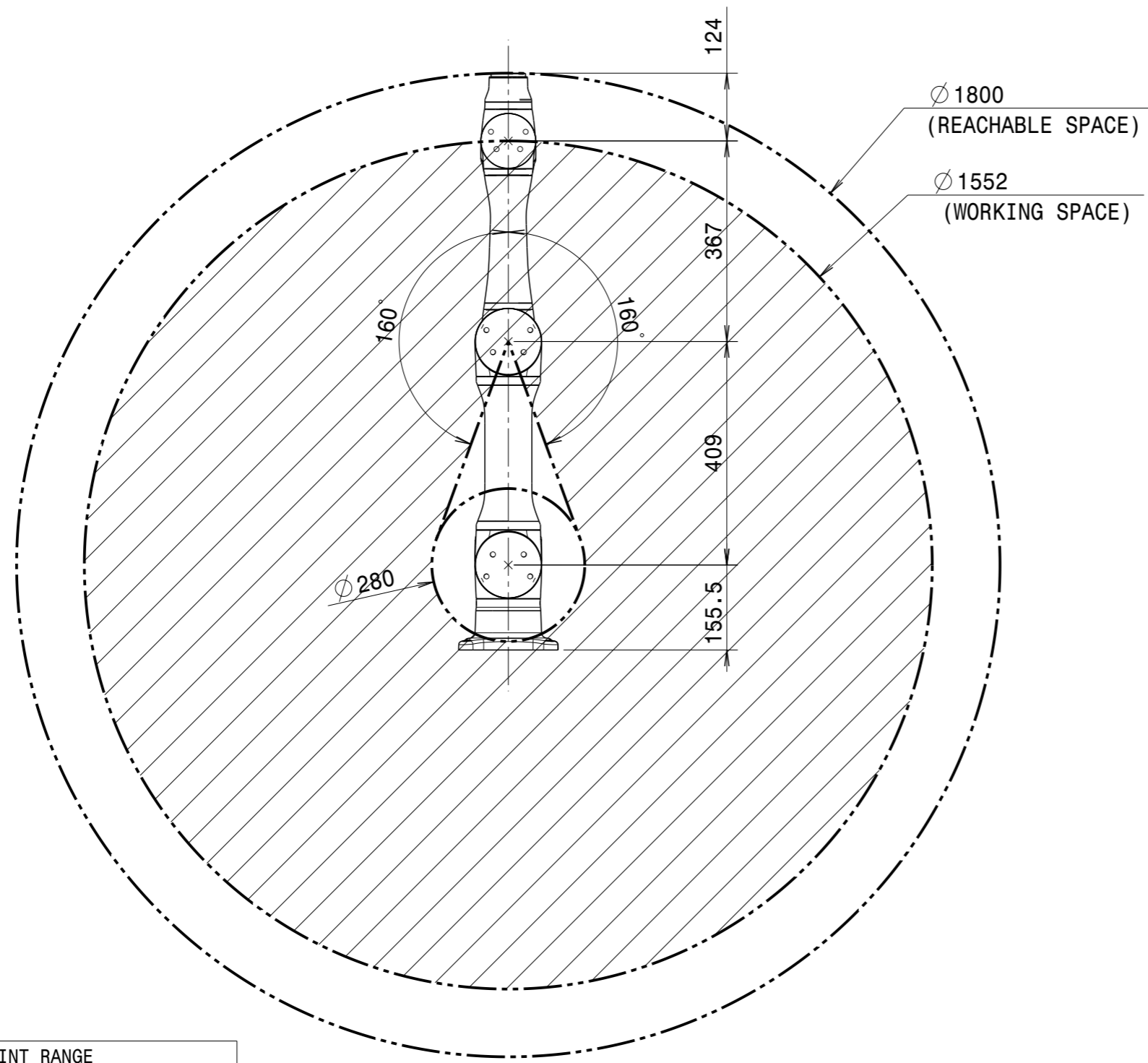

Front view (1:10)

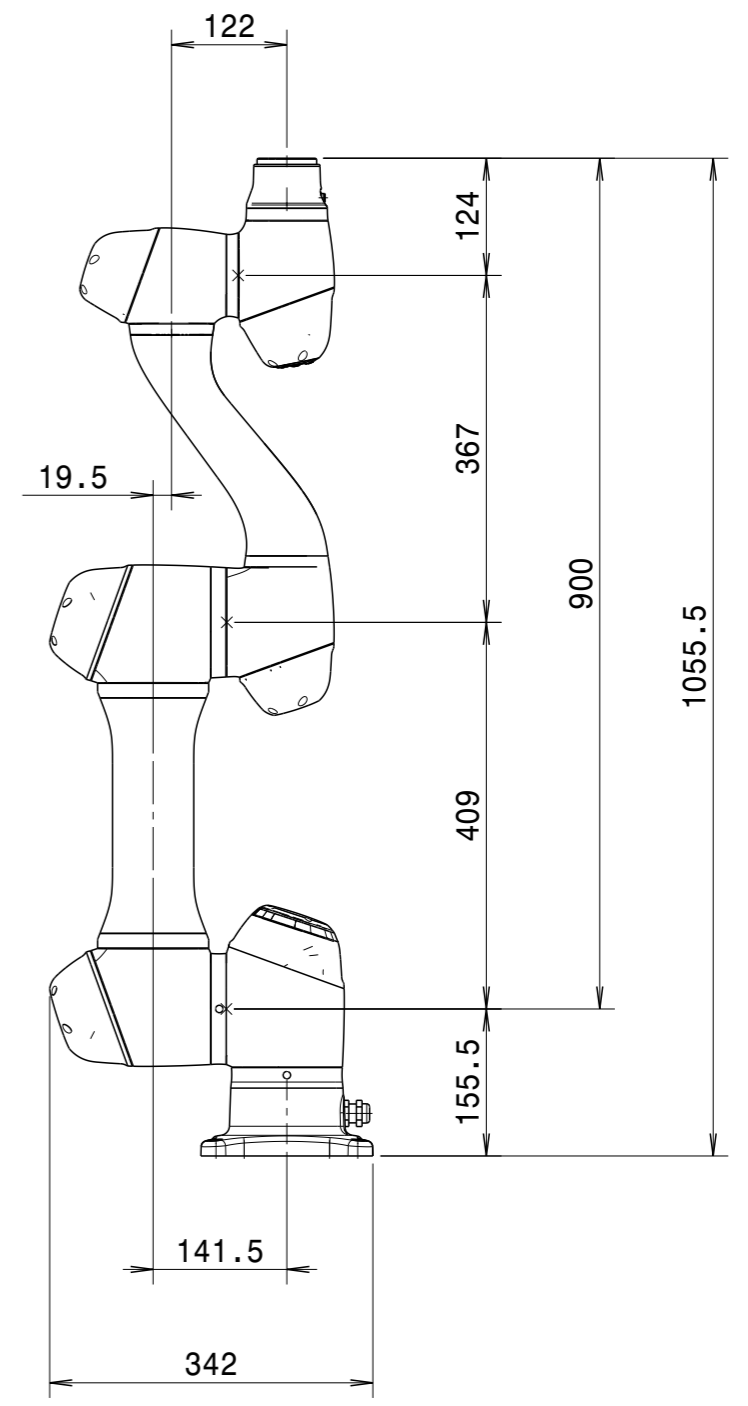

Side view (1:8)

JOINT RANGE	
AXIS	WORKING AREA (SOFTWARE LIMIT) / DEGREE
1	-360 ~ 360
2	-360 ~ 360
3	-160 ~ 160
4	-360 ~ 360
5	-360 ~ 360
6	-360 ~ 360
PAYLOAD	5kg
REACH	900mm

TITLE	LAYOUT		Q'TY	1
MODEL	A0509		W.T (kg)	21
SERIES	MAT.		SCALE	
A-SERIES	DRG. NO.	A3		
DATE	21.03.03			
			DOOSAN	