

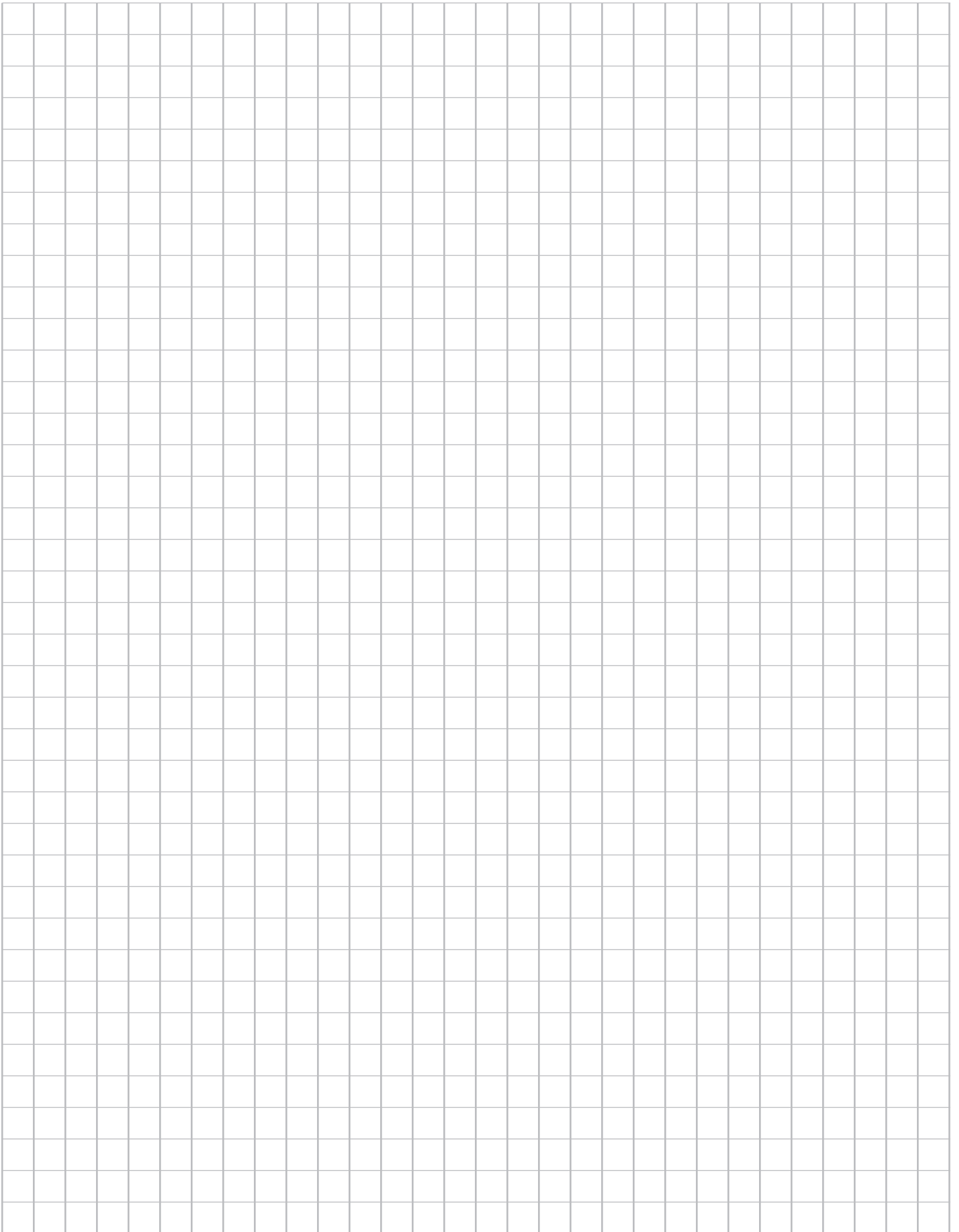

[www.spctrade.com](http://www.spctrade.com)

---

A large, empty grid of small squares occupies the central portion of the page. The grid is composed of 20 columns and 30 rows of squares, providing a space for calculations or data entry.

# TABLE OF CONTENTS

<i>One Touch Fittings</i> .....	4
<i>Compact One Touch Fittings</i> .....	14
<i>Metallic Fittings</i> ....	17
<i>Water Fittings</i> .....	21
<i>Speed Controllers</i> .....	24
<i>Rotary Joints..</i> .....	26
<i>Stop Fittings</i> .....	28
<i>Ball Valves</i> .....	29
<i>Check Valves</i> .....	30
<i>Hand Valves</i> .....	31
<i>Breather Vents and Mufflers</i> .....	33
<i>Tubing</i> .....	34
<i>Air Guns</i> .....	34



SPC is a registered trade name for Sang-A Pneumatic Co., Ltd. in North America. The SPC brand logo represents products that are specified in the inch system. Both Sang-A and SPC logos are the registered trade marks Co Sang-A Pneumatic Co., Ltd.



Sang-A is a registered trade name for Sang-A Pneumatic Co., Ltd. in Europe and Asia. The Sang-A brand logo represents products that are specified in the Metric system.

# ONE TOUCH FITTINGS

## Application:

- One-touch fittings used for pneumatic piping
- Wide variety of models available to meet all needs

## Features:

- Elliptical sleeve allows easy connect/disconnect by one touch
- Straight fitting type useful for piping in confined space by fastening through internal hex
- Fittings include NBR O-ring and Teflon treated threads

## STRUCTURAL DIAGRAM

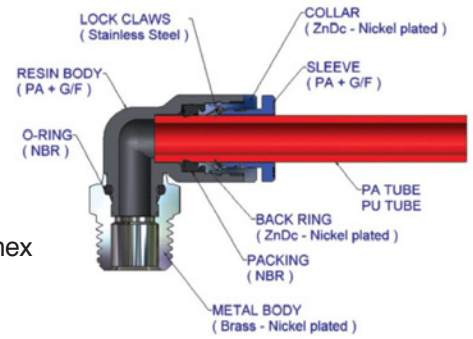

## ONE TOUCH FITTINGS

### PRODUCT CODE SYSTEM

PC	1/4	-	N02	U	EPNI
1	2		3	4	5

#### (1) Type

#### (2) Tube Diameter (ØD)

Inch Size		Metric Size	
Code	Dia	Code	Dia
5/32	5/32"	03	3 mm
3/16	3/16"	04	4 mm
1/4	1/4"	06	6 mm
5/16	5/16"	08	8 mm
3/8	3/8"	10	10 mm
1/2	1/2"	12	12 mm
		14	14 mm
		16	16 mm

#### (3) Thread Sizes (R)

Tapered Thread		Parallel Thread	
Code	Thread	Code	Thread
N1/16	N1/16" NPT	G01	G1/8" BSPP
N01	N1/8" NPT	G02	G1/4" BSPP
N02	N1/4" NPT	G03	G3/8" BSPP
N03	N3/8" NPT	G04	G1/2" BSPP
N04	N1/2" NPT	U10U	10-32 UNF
01	R1/8" BSPT	M3	M3 x 0.5
02	R1/4" BSPT	M5	M5 x 0.8
03	R3/8" BSPT	M6	M6 x 1.0
04	R1/2" BSPT		

#### (4) Hexagon Specification

U = Flat-to-flat Inch specification (NPT)  
No code = Flat-to-flat Metric specification

#### (5) Features

Code	Feature
C	Compact Fitting
O	Meter Out Flow Direction
I	Meter In Flow Direction
EPNI	Electro Plated Nickel

\*All fittings with metal bodies are nickel plated including part #1's that may not include EPNI

Specifications	
Fluid	AIR (No other gases or liquids)
Working Pressure Range	0 ~ 284 psi    0 ~ 1958 kPa
Negative Pressure	-14.5 psi    -100 kPa
Temperature Range	32 ~ 176F    0 ~ 80C
Applicable Tubing	Polyurethane and Nylon

#### Case In Use

► POC/PCC Models  
Hexagonal wrench must be used inside of body to fasten fitting due to round exterior

► PLPT Models  
Elbow and Tee fittings allow for swivel adjustment to desired position after fastening base

## Model (ØD-R)

	ØD (Inch) - R (NPT)	Bag Qty	ØD (Inch) - R (BSPT)	Bag Qty	ØD (Metric) - R (BSPT)	Bag Qty	ØD (Metric) - R (BSPP)	Bag Qty
<b>PC</b> <b>MALE STRAIGHT</b> 	PC 5/32-N01U EPNI	10	PC 5/32-R01 EPNI	10	GPC 0401 EPNI	10	GPC 04G01 EPNI	10
	PC 5/32-N02U EPNI	10	PC 5/32-R02 EPNI	10	GPC 0402 EPNI	10	GPC 04G02 EPNI	10
	PC 5/32-N03U EPNI	10	PC 5/32-R03 EPNI	10	GPC 0403 EPNI	10	GPC 04G03 EPNI	10
	PC 5/32-U10U EPNI	10	PC 3/16-R01 EPNI	10	GPC 04M5 EPNI	10	GPC 06G01 EPNI	10
	PC 3/16-N01U EPNI	10	PC 3/16-R02 EPNI	10	GPC 04M6 EPNI	10	GPC 06G02 EPNI	10
	PC 3/16-N02U EPNI	10	PC 3/16-R03 EPNI	10	GPC 0601 EPNI	10	GPC 06G03 EPNI	10
	PC 3/16-N03U EPNI	10	PC 1/4-R01 EPNI	10	GPC 0602 EPNI	10	GPC 06G04 EPNI	10
	PC 3/16-U10U EPNI	10	PC 1/4-R02 EPNI	10	GPC 0603 EPNI	10	GPC 08G01 EPNI	10
	PC 1/4-N01U EPNI	10	PC 1/4-R03 EPNI	10	GPC 0604 EPNI	10	GPC 08G02 EPNI	10
	PC 1/4-N02U EPNI	10	PC 1/4-R04 EPNI	10	GPC 06M5 EPNI	10	GPC 08G03 EPNI	10
	PC 1/4-N03U EPNI	10	PC 5/16-R01 EPNI	10	GPC 06M6 EPNI	10	GPC 08G04 EPNI	10
	PC 1/4-N04U EPNI	10	PC 5/16-R02 EPNI	10	GPC 0801 EPNI	10	GPC 10G01 EPNI	10
	PC 1/4-U10U EPNI	10	PC 5/16-R03 EPNI	10	GPC 0802 EPNI	10	GPC 10G02 EPNI	10
	PC 5/16-N01U EPNI	10	PC 5/16-R04 EPNI	10	GPC 0803 EPNI	10	GPC 10G03 EPNI	10
	PC 5/16-N02U EPNI	10	PC 3/8-R01 EPNI	10	GPC 0804 EPNI	10	GPC 10G04 EPNI	10
	PC 5/16-N03U EPNI	10	PC 3/8-R02 EPNI	10	GPC 1001 EPNI	10	GPC 12G01 EPNI	10
	PC 5/16-N04U EPNI	10	PC 3/8-R03 EPNI	10	GPC 1002 EPNI	10	GPC 12G02 EPNI	10
	PC 3/8-N01U EPNI	10	PC 3/8-R04 EPNI	10	GPC 1003 EPNI	10	GPC 12G03 EPNI	10
	PC 3/8-N02U EPNI	10	PC 1/2-R01 EPNI	10	GPC 1004 EPNI	10	GPC 12G04 EPNI	5
	PC 3/8-N03U EPNI	10	PC 1/2-R02 EPNI	10	GPC 1201 EPNI	10	GPC 14G03 EPNI	5
	PC 3/8-N04U EPNI	10	PC 1/2-R03 EPNI	10	GPC 1202 EPNI	10	GPC 14G04 EPNI	5
	PC 1/2-N01U EPNI	10	PC 1/2-R04 EPNI	5	GPC 1203 EPNI	10	GPC 16G03 EPNI	5
	PC 1/2-N02U EPNI	10			GPC 1204 EPNI	5	GPC 16G04 EPNI	5
	PC 1/2-N03U EPNI	10			GPC 1403 EPNI	5		
	PC 1/2-N04U EPNI	5			GPC 1404 EPNI	5		
					GPC 1603 EPNI	5		
					GPC 1604 EPNI	5		

## Model (ØD-R)

	ØD (Inch) - R (NPT)	Bag Qty	ØD (Inch) - R (BSPT)	Bag Qty	ØD (Metric) - R (BSPT)	Bag Qty	ØD (Metric) - R (BSPP)	Bag Qty
<b>POC</b> <b>ROUND MALE STRAIGHT</b> 	POC 5/32-N01U EPNI	10	POC 1/4-R01 EPNI	10	GPOC 0401 EPNI	10	GPOC 04G01 EPNI	10
	POC 5/32-N02U EPNI	10	POC 1/4-R02 EPNI	10	GPOC 0402 EPNI	10	GPOC 04G02 EPNI	10
	POC 5/32-N03U EPNI	10	POC 5/16-R01 EPNI	10	GPOC 0403 EPNI	10	GPOC 04G03 EPNI	10
	POC 5/32-U10U EPNI	10	POC 5/16-R02 EPNI	10	GPOC 04M5 EPNI	10	GPOC 06G01 EPNI	10
	POC 3/16-N01 EPNI	10	POC 5/16-R03 EPNI	10	GPOC 04M6 EPNI	10	GPOC 06G02 EPNI	10
	POC 3/16-N02 EPNI	10	POC 3/8-R02 EPNI	10	GPOC 0601 EPNI	10	GPOC 06G03 EPNI	10
	POC 3/16-U10U EPNI	10	POC 3/8-R03 EPNI	10	GPOC 0602 EPNI	10	GPOC 08G01 EPNI	10
	POC 1/4-N01U EPNI	10	POC 3/8-R04 EPNI	10	GPOC 0603 EPNI	10	GPOC 08G02 EPNI	10
	POC 1/4-N02U EPNI	10			GPOC 06M5 EPNI	10	GPOC 08G03 EPNI	10
	POC 1/4-U10U EPNI	10			GPOC 06M6 EPNI	10	GPOC 08G04 EPNI	10
	POC 5/16-N01U EPNI	10			GPOC 0801 EPNI	10	GPOC 10G01 EPNI	10
	POC 5/16-N02U EPNI	10			GPOC 0802 EPNI	10	GPOC 10G02 EPNI	10
	POC 5/16-N03U EPNI	10			GPOC 0803 EPNI	10	GPOC 10G03 EPNI	10
	POC 5/16-N04U EPNI	10			GPOC 0804 EPNI	10	GPOC 10G04 EPNI	10
	POC 3/8-N01U EPNI	10			GPOC 1001 EPNI	10	GPOC 12G01 EPNI	10
	POC 3/8-N02U EPNI	10			GPOC 1002 EPNI	10	GPOC 12G02 EPNI	10
	POC 3/8-N03U EPNI	10			GPOC 1003 EPNI	10	GPOC 12G03 EPNI	10
	POC 3/8-N04U EPNI	10			GPOC 1004 EPNI	10	GPOC 12G04 EPNI	5
	POC 1/2-N02U EPNI	10			GPOC 1201 EPNI	10		
	POC 1/2-N03U EPNI	10			GPOC 1202 EPNI	10		
POC 1/2-N04U EPNI	5			GPOC 1203 EPNI	10			
				GPOC 1204 EPNI	5			

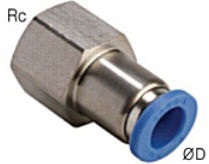

### Model (ØD-R)

	ØD (Inch) - R (NPT) Bag Qty	ØD (Inch) - R (BSPT) Bag Qty	ØD (Metric) - R (BSPT) Bag Qty	ØD (Metric) - R (BSPP) Bag Qty
<b>PCF</b> FEMALE STRAIGHT  	PCF 5/32-N01U EPNI .....10	PCF 5/32-Rc01 EPNI .....10	GPCF 0401 EPNI .....10	GPCF 04G01 EPNI .....10
	PCF 5/32-N02U EPNI .....10	PCF 5/32-Rc02 EPNI .....10	GPCF 0402 EPNI .....10	GPCF 04G02 EPNI .....10
	PCF 3/16-N01U EPNI .....10	PCF 5/32-Rc03 EPNI .....10	GPCF 0403 EPNI .....10	GPCF 04G03 EPNI .....10
	PCF 3/16-N02U EPNI .....10	PCF 3/16-Rc01 EPNI .....10	GPCF 0601 EPNI .....10	GPCF 06G01 EPNI .....10
	PCF 1/4-N01U EPNI .....10	PCF 3/16-Rc02 EPNI .....10	GPCF 0602 EPNI .....10	GPCF 06G02 EPNI .....10
	PCF 1/4-N02U EPNI .....10	PCF 1/4-Rc01 EPNI .....10	GPCF 0603 EPNI .....10	GPCF 06G03 EPNI .....10
	PCF 1/4-N03U EPNI .....10	PCF 1/4-Rc02 EPNI .....10	GPCF 0801 EPNI .....10	GPCF 08G01 EPNI .....10
	PCF 5/16-N01U EPNI .....10	PCF 1/4-Rc03 EPNI .....10	GPCF 0802 EPNI .....10	GPCF 08G02 EPNI .....10
	PCF 5/16-N02U EPNI .....10	PCF 5/16-Rc01 EPNI .....10	GPCF 0803 EPNI .....10	GPCF 08G03 EPNI .....10
	PCF 5/16-N03U EPNI .....10	PCF 5/16-Rc02 EPNI .....10	GPCF 0804 EPNI .....5	GPCF 08G04 EPNI .....5
	PCF 5/16-N04U EPNI .....5	PCF 5/16-Rc03 EPNI .....10	GPCF 1001 EPNI .....10	GPCF 10G01 EPNI .....10
	PCF 3/8-N01U EPNI .....10	PCF 5/16-Rc04 EPNI .....5	GPCF 1002 EPNI .....10	GPCF 10G02 EPNI .....10
	PCF 3/8-N02U EPNI .....10	PCF 3/8-Rc01 EPNI .....10	GPCF 1003 EPNI .....5	GPCF 10G03 EPNI .....5
	PCF 3/8-N03U EPNI .....5	PCF 3/8-Rc02 EPNI .....10	GPCF 1004 EPNI .....5	GPCF 10G04 EPNI .....5
	PCF 3/8-N04U EPNI .....5	PCF 3/8-Rc03 EPNI .....5	GPCF 1202 EPNI .....5	GPCF 12G02 EPNI .....5
	PCF 1/2-N02U EPNI .....5	PCF 3/8-Rc04 EPNI .....5	GPCF 1203 EPNI .....5	GPCF 12G03 EPNI .....5
	PCF 1/2-N03U EPNI .....5	PCF 1/2-Rc02 EPNI .....5	GPCF 1204 EPNI .....5	GPCF 12G04 EPNI .....5
	PCF 1/2-N04U EPNI .....5	PCF 1/2-Rc03 EPNI .....5	GPCF 1604 EPNI .....3	GPCF 16G04 EPNI .....3
		PCF 1/2-Rc04 EPNI .....5		

### Model (ØD-R)

	ØD (Inch) - R (NPT) Bag Qty	ØD (Inch) - R (BSPT) Bag Qty	ØD (Metric) - R (BSPT) Bag Qty	ØD (Metric) - R (BSPP) Bag Qty
<b>PL</b> MALE ELBOW  	PL 5/32-N01U EPNI .....10	PL 5/32-R01 EPNI .....10	GPL 0401 EPNI .....10	GPL 04G01 EPNI .....10
	PL 5/32-N02U EPNI .....10	PL 5/32-R02 EPNI .....10	GPL 0402 EPNI .....10	GPL 04G02 EPNI .....10
	PL 5/32-N03U EPNI .....10	PL 5/32-R03 EPNI .....10	GPL 0403 EPNI .....10	GPL 04G03 EPNI .....10
	PL 5/32-U10U EPNI .....10	PL 3/16-R01 EPNI .....10	GPL 04M5 EPNI .....10	GPL 06G01 EPNI .....10
	PL 3/16-N01U EPNI .....10	PL 3/16-R02 EPNI .....10	GPL 04M6 EPNI .....10	GPL 06G02 EPNI .....10
	PL 3/16-N02U EPNI .....10	PL 3/16-R03 EPNI .....10	GPL 0601 EPNI .....10	GPL 06G03 EPNI .....10
	PL 3/16-N03U EPNI .....10	PL 1/4-R01 EPNI .....10	GPL 0602 EPNI .....10	GPL 06G04 EPNI .....5
	PL 3/16-U10U EPNI .....10	PL 1/4-R02 EPNI .....10	GPL 0603 EPNI .....10	GPL 08G01 EPNI .....10
	PL 1/4-N01U EPNI .....10	PL 1/4-R03 EPNI .....10	GPL 0604 EPNI .....5	GPL 08G02 EPNI .....10
	PL 1/4-N02U EPNI .....10	PL 1/4-R04 EPNI .....10	GPL 06M5 EPNI .....10	GPL 08G03 EPNI .....10
	PL 1/4-N03U EPNI .....10	PL 5/16-R01 EPNI .....10	GPL 06M6 EPNI .....10	GPL 08G04 EPNI .....5
	PL 1/4-N04U EPNI .....10	PL 5/16-R02 EPNI .....10	GPL 0801 EPNI .....10	GPL 10G01 EPNI .....10
	PL 1/4-U10U EPNI .....10	PL 5/16-R03 EPNI .....10	GPL 0802 EPNI .....10	GPL 10G02 EPNI .....5
	PL 5/16-N01U EPNI .....10	PL 5/16-R04 EPNI .....5	GPL 0803 EPNI .....10	GPL 10G03 EPNI .....5
	PL 5/16-N02U EPNI .....10	PL 3/8-R01 EPNI .....10	GPL 0804 EPNI .....5	GPL 10G04 EPNI .....5
	PL 5/16-N03U EPNI .....10	PL 3/8-R02 EPNI .....5	GPL 1001 EPNI .....10	GPL 12G01 EPNI .....5
	PL 5/16-N04U EPNI .....5	PL 3/8-R03 EPNI .....5	GPL 1002 EPNI .....5	GPL 12G02 EPNI .....5
	PL 3/8-N01U EPNI .....10	PL 3/8-R04 EPNI .....5	GPL 1003 EPNI .....5	GPL 12G03 EPNI .....5
	PL 3/8-N02U EPNI .....5	PL 1/2-R01 EPNI .....5	GPL 1004 EPNI .....5	GPL 12G04 EPNI .....5
	PL 3/8-N03U EPNI .....5	PL 1/2-R02 EPNI .....5	GPL 1201 EPNI .....5	GPL 14G03 EPNI .....5
PL 3/8-N04U EPNI .....5	PL 1/2-R03 EPNI .....5	GPL 1202 EPNI .....5	GPL 14G04 EPNI .....5	
PL 1/2-N01U EPNI .....5	PL 1/2-R04 EPNI .....5	GPL 1203 EPNI .....5	GPL 16G03 EPNI .....5	
PL 1/2-N02U EPNI .....5		GPL 1204 EPNI .....5	GPL 16G04 EPNI .....5	
PL 1/2-N03U EPNI .....5		GPL 1403 EPNI .....5		
PL 1/2-N04U EPNI .....5		GPL 1404 EPNI .....5		
		GPL 1603 EPNI .....5		
		GPL 1604 EPNI .....5		

### Model (ØD-R)

	ØD (Inch) - R (NPT) Bag Qty	ØD (Inch) - R (BSPT) Bag Qty	ØD (Metric) - R (BSPT) Bag Qty	ØD (Metric) - R (BSPP) Bag Qty
<b>PL45</b> MALE 45 ELBOW  	PL45 5/32-N01U EPNI .....10	PL45 5/32-01 EPNI .....10	GPL45 0401 EPNI .....10	GPL45 04G01 EPNI .....10
	PL45 5/32-N02U EPNI .....10	PL45 5/32-02 EPNI .....10	GPL45 0402 EPNI .....10	GPL45 04G02 EPNI .....10
	PL45 5/32-N03U EPNI .....10	PL45 5/32-03 EPNI .....10	GPL45 0403 EPNI .....10	GPL45 04G03 EPNI .....10
	PL45 5/32-U10U EPNI .....10	PL45 5/32-M5 EPNI .....10	GPL45 04M5 EPNI .....10	GPL45 06G01 EPNI .....10
	PL45 3/16-N01U EPNI .....10	PL45 5/32-M6 EPNI .....10	GPL45 04M6 EPNI .....10	GPL45 06G02 EPNI .....10
	PL45 3/16-N02U EPNI .....10	PL45 3/16-01 EPNI .....10	GPL45 0601 EPNI .....10	GPL45 06G03 EPNI .....10
	PL45 3/16-N03U EPNI .....10	PL45 3/16-02 EPNI .....10	GPL45 0602 EPNI .....10	GPL45 06G04 EPNI .....10
	PL45 3/16-U10U EPNI .....10	PL45 3/16-03 EPNI .....10	GPL45 0603 EPNI .....10	GPL45 08G01 EPNI .....10
	PL45 1/4-N01U EPNI .....10	PL45 3/16-M5 EPNI .....10	GPL45 0604 EPNI .....10	GPL45 08G02 EPNI .....10
	PL45 1/4-N02U EPNI .....10	PL45 1/4-01 EPNI .....10	GPL45 06M5 EPNI .....10	GPL45 08G03 EPNI .....10
	PL45 1/4-N03U EPNI .....10	PL45 1/4-02 EPNI .....10	GPL45 06M6 EPNI .....10	GPL45 08G04 EPNI .....5
	PL45 1/4-N04U EPNI .....10	PL45 1/4-03 EPNI .....10	GPL45 0801 EPNI .....10	GPL45 10G01 EPNI .....5
	PL45 1/4-U10U EPNI .....10	PL45 1/4-04 EPNI .....10	GPL45 0802 EPNI .....10	GPL45 10G02 EPNI .....5
	PL45 5/16-N01U EPNI .....10	PL45 1/4-M5 EPNI .....10	GPL45 0803 EPNI .....10	GPL45 10G03 EPNI .....5
	PL45 5/16-N02U EPNI .....10	PL45 1/4-M6 EPNI .....10	GPL45 0804 EPNI .....5	GPL45 10G04 EPNI .....5
	PL45 5/16-N03U EPNI .....10	PL45 5/16-01 EPNI .....10	GPL45 0805 EPNI .....5	GPL45 12G01 EPNI .....5
	PL45 5/16-N04U EPNI .....10	PL45 5/16-02 EPNI .....10	GPL45 1002 EPNI .....5	GPL45 12G02 EPNI .....5
	PL45 3/8-N01U EPNI .....10	PL45 5/16-03 EPNI .....10	GPL45 1003 EPNI .....5	GPL45 12G03 EPNI .....5
	PL45 3/8-N02U EPNI .....10	PL45 5/16-04 EPNI .....5	GPL45 1004 EPNI .....5	GPL45 12G04 EPNI .....5
	PL45 3/8-N03U EPNI .....10	PL45 3/8-01 EPNI .....10	GPL45 1201 EPNI .....5	
PL45 3/8-N04U EPNI .....5	PL45 3/8-02 EPNI .....5	GPL45 1202 EPNI .....5		
PL45 1/2-N01U EPNI .....5	PL45 3/8-03 EPNI .....5	GPL45 1203 EPNI .....5		
PL45 1/2-N02U EPNI .....5	PL45 3/8-04 EPNI .....5	GPL45 1204 EPNI .....5		
PL45 1/2-N03U EPNI .....5	PL45 1/2-01 EPNI .....5			
PL45 1/2-N04U EPNI .....5	PL45 1/2-02 EPNI .....5			
	PL45 1/2-03 EPNI .....5			
	PL45 1/2-04 EPNI .....5			

### Model (ØD-R)

	ØD (Inch) - R (NPT) Bag Qty	ØD (Inch) - R (BSPT) Bag Qty	ØD (Metric) - R (BSPT) Bag Qty	ØD (Metric) -R (BSPP) Bag Qty
<b>PLL</b> EXTENDED MALE ELBOW  	PLL 5/32-N01U EPNI .....10	PLL 5/32-M5 EPNI.....10	GPLL 0401 EPNI.....10	GPLL 04G01 EPNI .....10
	PLL 5/32-N02U EPNI .....10	PLL 5/32-M6 EPNI.....10	GPLL 0402 EPNI.....10	GPLL 04G02 EPNI .....10
	PLL 5/32-N03U EPNI .....10	PLL 5/32-R01 EPNI .....10	GPLL 0403 EPNI .....10	GPLL 04G03 EPNI .....10
	PLL 5/32-U10U EPNI .....10	PLL 5/32-R02 EPNI .....10	GPLL 04M5 EPNI .....10	GPLL 06G01 EPNI .....10
	PLL 3/16-N01U EPNI .....10	PLL 5/32-R03 EPNI .....10	GPLL 04M6 EPNI .....10	GPLL 06G02 EPNI .....10
	PLL 3/16-N02U EPNI .....10	PLL 3/16-R01 EPNI .....10	GPLL 0601 EPNI .....10	GPLL 06G03 EPNI .....10
	PLL 3/16-N03U EPNI .....10	PLL 3/16-R02 EPNI .....10	GPLL 0602 EPNI .....10	GPLL 06G04 EPNI .....5
	PLL 1/4-N01U EPNI .....10	PLL 3/16-R03 EPNI .....10	GPLL 0603 EPNI .....10	GPLL 08G01 EPNI .....10
	PLL 1/4-N02U EPNI .....10	PLL 3/16-M5 EPNI.....10	GPLL 06M5 EPNI .....10	GPLL 08G02 EPNI .....10
	PLL 1/4-N03U EPNI .....10	PLL 1/4-R01 EPNI .....10	GPLL 06M6 EPNI .....10	GPLL 08G03 EPNI .....5
	PLL 1/4-U10U EPNI .....10	PLL 1/4-R02 EPNI .....10	GPLL 0801 EPNI .....10	GPLL 08G04 EPNI .....5
	PLL 5/16-N01U EPNI .....10	PLL 1/4-R03 EPNI .....10	GPLL 0802 EPNI .....10	GPLL 10G01 EPNI .....5
	PLL 5/16-N02U EPNI .....10	PLL 1/4-M5 EPNI .....10	GPLL 0803 EPNI .....5	GPLL 10G02 EPNI .....5
	PLL 5/16-N03U EPNI .....5	PLL 1/4-M6 EPNI.....10	GPLL 0804 EPNI .....5	GPLL 10G03 EPNI .....5
	PLL 3/8-N01U EPNI .....5	PLL 5/16-R01 EPNI .....10	GPLL 1001 EPNI .....5	GPLL 10G04 EPNI .....5
	PLL 3/8-N02U EPNI .....5	PLL 5/16-R02 EPNI .....10	GPLL 1002 EPNI .....5	GPLL 12G01 EPNI .....5
	PLL 3/8-N03U EPNI .....5	PLL 5/16-R03 EPNI .....5	GPLL 1003 EPNI .....5	GPLL 12G02 EPNI .....5
	PLL 3/8-N04U EPNI .....5	PLL 5/16-R04 EPNI .....5	GPLL 1004 EPNI .....5	GPLL 12G03 EPNI .....5
	PLL 1/2-N02U EPNI .....5	PLL 3/8-R01 EPNI .....5	GPLL 1201 EPNI .....5	GPLL 12G04 EPNI .....5
	PLL 1/2-N03U EPNI .....5	PLL 3/8-R02 EPNI .....5	GPLL 1202 EPNI .....5	GPLL 14G03 EPNI .....4
PLL 1/2-N04U EPNI .....5	PLL 3/8-R03 EPNI .....5	GPLL 1203 EPNI .....5	GPLL 14G04 EPNI .....4	
	PLL 3/8-R04 EPNI .....5	GPLL 1204 EPNI .....5	GPLL 16G04 EPNI .....4	
	PLL 1/2-R01 EPNI .....5	GPLL 1403 EPNI .....4		
	PLL 1/2-R02 EPNI .....5	GPLL 1404 EPNI .....4		
	PLL 1/2-R03 EPNI .....5	GPLL 1604 EPNI .....4		
	PLL 1/2-R04 EPNI .....5			

### Model (ØD-R)

	ØD (Inch) - R (NPT) Bag Qty	ØD (Inch) - R (BSPT) Bag Qty	ØD (Metric) - R (BSPT) Bag Qty	ØD (Metric) -R (BSPP) Bag Qty
<b>PLLP</b> EXTENDED MALE ELBOW PLASTIC  	PLLP 5/32-N01U EPNI .....10	PLLP 5/32-01 EPNI .....10	GPLLP 0401 EPNI.....10	GPLLP 04G01 EPNI .....10
	PLLP 5/32-N02U EPNI .....10	PLLP 5/32-02 EPNI .....10	GPLLP 0402 EPNI.....10	GPLLP 04G02 EPNI .....10
	PLLP 5/32-N03U EPNI .....10	PLLP 5/32-03 EPNI .....10	GPLLP 0403 EPNI.....10	GPLLP 04G03 EPNI .....10
	PLLP 5/32-U10U EPNI .....10	PLLP 5/32-M5 EPNI .....10	GPLLP 04M5 EPNI .....10	GPLLP 06G01 EPNI .....10
	PLLP 1/4-N01U EPNI .....10	PLLP 1/4-01 EPNI .....10	GPLLP 04M6 EPNI .....10	GPLLP 06G02 EPNI .....10
	PLLP 1/4-N02U EPNI .....10	PLLP 1/4-02 EPNI .....10	GPLLP 0601 EPNI .....10	GPLLP 06G03 EPNI .....10
	PLLP 1/4-N03U EPNI .....10	PLLP 1/4-03 EPNI .....5	GPLLP 0602 EPNI .....10	GPLLP 06G04 EPNI .....5
	PLLP 1/4-N04U EPNI .....5	PLLP 1/4-04 EPNI .....5	GPLLP 0603 EPNI .....10	GPLLP 08G01 EPNI .....10
	PLLP 1/4-U10U EPNI .....10	PLLP 1/4-M5 EPNI .....10	GPLLP 0604 EPNI .....5	GPLLP 08G02 EPNI .....10
	PLLP 5/16-N01U EPNI .....10	PLLP 5/16-01 EPNI .....10	GPLLP 06M5 EPNI .....10	GPLLP 08G03 EPNI .....5
	PLLP 5/16-N02U EPNI .....10	PLLP 5/16-02 EPNI .....10	GPLLP 06M6 EPNI .....10	GPLLP 08G04 EPNI .....5
	PLLP 5/16-N03U EPNI .....5	PLLP 5/16-03 EPNI .....5	GPLLP 0801 EPNI .....10	GPLLP 10G01 EPNI .....5
	PLLP 5/16-N04U EPNI .....5	PLLP 5/16-04 EPNI .....5	GPLLP 0802 EPNI .....10	GPLLP 10G02 EPNI .....5
	PLLP 3/8-N01U EPNI .....5	PLLP 3/8-01 EPNI .....5	GPLLP 0803 EPNI .....5	GPLLP 10G03 EPNI .....5
	PLLP 3/8-N02U EPNI .....5	PLLP 3/8-02 EPNI .....5	GPLLP 0804 EPNI .....5	GPLLP 10G04 EPNI .....5
	PLLP 3/8-N03U EPNI .....5	PLLP 3/8-03 EPNI .....5	GPLLP 1001 EPNI .....5	GPLLP 12G01 EPNI .....5
	PLLP 3/8-N04U EPNI .....5	PLLP 3/8-04 EPNI .....5	GPLLP 1002 EPNI .....5	GPLLP 12G02 EPNI .....5
	PLLP 1/2-N02U EPNI .....5	PLLP 1/2-02 EPNI .....5	GPLLP 1003 EPNI .....5	GPLLP 12G03 EPNI .....5
	PLLP 1/2-N03U EPNI .....5	PLLP 1/2-03 EPNI .....5	GPLLP 1004 EPNI .....5	GPLLP 12G04 EPNI .....5
	PLLP 1/2-N04U EPNI .....5	PLLP 1/2-04 EPNI .....5	GPLLP 1202 EPNI .....5	
		GPLLP 1203 EPNI .....5		
		GPLLP 1204 EPNI .....5		

### Model (ØD-R)

	ØD (Inch) - R (NPT) Bag Qty	ØD (Metric) - R (BSPT) Bag Qty	ØD (Metric) - R (BSPP) Bag Qty
<b>PLF</b> FEMALE ELBOW  	PLF 5/32-N01U EPNI .....10	GPLF 0401 EPNI .....10	GPLF 04G01 EPNI .....10
	PLF 5/32-N02U EPNI .....10	GPLF 0402 EPNI .....10	GPLF 04G02 EPNI .....10
	PLF 5/32-U10U EPNI .....10	GPLF 04M5 EPNI .....10	GPLF 06G01 EPNI .....10
	PLF 3/16-N01 EPNI .....10	GPLF 04M6 EPNI .....10	GPLF 06G02 EPNI .....10
	PLF 3/16-N02 EPNI .....10	GPLF 0601 EPNI .....10	GPLF 06G03 EPNI .....5
	PLF 3/16-U10U EPNI .....10	GPLF 0602 EPNI .....10	GPLF 08G01 EPNI .....10
	PLF 1/4-N01U EPNI .....10	GPLF 0603 EPNI .....5	GPLF 08G02 EPNI .....10
	PLF 1/4-N02U EPNI .....10	GPLF 06M5 EPNI .....10	GPLF 08G03 EPNI .....5
	PLF 1/4-N03U EPNI .....10	GPLF 06M6 EPNI .....10	GPLF 10G02 EPNI .....5
	PLF 1/4-U10U EPNI .....10	GPLF 0801 EPNI .....10	GPLF 10G03 EPNI .....5
	PLF 5/16-N01U EPNI .....10	GPLF 0802 EPNI .....10	GPLF 10G04 EPNI .....5
	PLF 5/16-N02U EPNI .....10		GPLF 12G02 EPNI .....5
	PLF 5/16-N03U EPNI .....10		GPLF 12G03 EPNI .....5
	PLF 3/8-N01U EPNI .....5		GPLF 12G04 EPNI .....5
	PLF 3/8-N02U EPNI .....5		
	PLF 3/8-N03U EPNI .....5		
PLF 3/8-N04U EPNI .....5			

Model (ØD-R)				
	ØD (Inch) - R (NPT) Bag Qty	ØD (Inch) - R (BSPT) Bag Qty	ØD (Metric) - R (BSPT) Bag Qty	ØD (Metric) - R (BSPP) Bag Qty
<b>PH</b> MALE BANJO 	PH 5/32-N01U EPNI.....10	PH 5/32-M5 EPNI.....10	GPH 0401 EPNI .....10	GPH 04G01 EPNI.....10
	PH 5/32-U10U EPNI.....10	PH 5/32-R01 EPNI.....10	GPH 0402 EPNI .....10	GPH 04G02 EPNI.....10
	PH 3/16-N01U EPNI.....10	PH 1/4-M5 EPNI.....10	GPH 04M5 EPNI .....10	GPH 04G03 EPNI.....10
	PH 3/16-N02U EPNI.....10	PH 1/4-R01 EPNI.....10	GPH 0601 EPNI .....10	GPH 06G01 EPNI.....10
	PH 3/16-N03U EPNI.....10	PH 1/4-R02 EPNI.....10	GPH 0602 EPNI .....10	GPH 06G02 EPNI.....10
	PH 3/16-U10U EPNI.....10	PH 5/16-R01 EPNI.....10	GPH 0603 EPNI .....5	GPH 06G03 EPNI.....10
	PH 1/4-N01U EPNI.....10	PH 5/16-R02 EPNI.....10	GPH 06M5 EPNI .....10	GPH 08G01 EPNI.....10
	PH 1/4-N02U EPNI.....10	PH 1/4-R03 EPNI.....5	GPH 0801 EPNI .....10	GPH 08G02 EPNI.....10
	PH 1/4-U10U EPNI.....10	PH 3/8-R02 EPNI.....5	GPH 0802 EPNI .....10	GPH 08G03 EPNI.....5
	PH 5/16-N01U EPNI.....10	PH 3/8-R03 EPNI.....5	GPH 0803 EPNI .....5	GPH 08G04 EPNI.....5
	PH 5/16-N02U EPNI.....10	PH 3/8-R04 EPNI.....5	GPH 0804 EPNI .....5	GPH 10G02 EPNI.....5
	PH 5/16-N03U EPNI.....5	PH 1/2-R03 EPNI.....5	GPH 1002 EPNI .....5	GPH 10G03 EPNI.....5
	PH 3/8-N03U EPNI.....5	PH 1/2-R04 EPNI.....5	GPH 1003 EPNI .....5	GPH 10G04 EPNI.....5
	PH 3/8-N04U EPNI.....5		GPH 1004 EPNI .....5	GPH 12G03 EPNI.....5
	PH 1/2-N03U EPNI.....5		GPH 1202 EPNI .....5	GPH 12G04 EPNI.....5
	PH 1/2-N04U EPNI.....5		GPH 1203 EPNI .....5	
			GPH 1204 EPNI .....5	

Model (ØD-R)				
	ØD (Inch) - R (NPT) Bag Qty	ØD (Inch) - R (BSPT) Bag Qty	ØD (Metric) - R (BSPT) Bag Qty	ØD (Metric) - R (BSPP) Bag Qty
<b>PHF</b> FEMALE BANJO 	PHF 5/32-N01U EPNI.....10	PHF 5/32-M5 EPNI.....10	GPHF 0401 EPNI .....10	GPHF 04G01 EPNI .....10
	PHF 5/32-U10U EPNI.....10	PHF 5/32-R01 EPNI.....10	GPHF 0402 EPNI .....10	GPHF 06G01 EPNI .....10
	PHF 3/16-N01U EPNI.....10	PHF 1/4-M5 EPNI.....10	GPHF 04M5 EPNI .....10	GPHF 06G02 EPNI .....10
	PHF 3/16-N02U EPNI.....10	PHF 1/4-R01 EPNI.....10	GPHF 0601 EPNI .....10	GPHF 08G01 EPNI .....10
	PHF 3/16-U10U EPNI.....10	PHF 1/4-R02 EPNI.....10	GPHF 0602 EPNI .....10	GPHF 08G02 EPNI .....10
	PHF 1/4-N01U EPNI.....10	PHF 5/16-R01 EPNI.....10	GPHF 06M5 EPNI .....10	GPHF 08G03 EPNI .....5
	PHF 1/4-N02U EPNI.....10	PHF 5/16-R02 EPNI.....10	GPHF 0801 EPNI .....10	GPHF 10G02 EPNI .....5
	PHF 1/4-U10U EPNI.....10	PHF 5/16-R03 EPNI.....10	GPHF 0802 EPNI .....10	GPHF 10G03 EPNI .....5
	PHF 5/16-N01U EPNI.....10	PHF 3/8-R02 EPNI.....5	GPHF 0803 EPNI .....5	GPHF 12G03 EPNI .....5
	PHF 5/16-N02U EPNI.....10	PHF 3/8-R03 EPNI.....5	GPHF 1002 EPNI .....5	GPHF 12G04 EPNI .....5
	PHF 5/16-N03U EPNI.....10	PHF 1/2-R03 EPNI.....5	GPHF 1003 EPNI .....5	GPHF 04 G01-G01 EPNI .....10
	PHF 3/8-N02U EPNI.....5	PHF 1/2-R04 EPNI.....5	GPHF 1004 EPNI .....5	GPHF 06 G01-G01 EPNI .....10
	PHF 3/8-N03U EPNI.....5		GPHF 1202 EPNI .....5	GPHF 06 G02-G02 EPNI .....10
	PHF 1/2-N03U EPNI.....5		GPHF 1203 EPNI .....5	GPHF 08 G01-G01 EPNI .....10
	PHF 1/2-N04U EPNI.....5		GPHF 1204 EPNI .....5	GPHF 08 G02-G02 EPNI .....10
				GPHF 08 G03-G03 EPNI .....5
				GPHF 10 G02-G02 EPNI .....5
				GPHF 10 G03-G03 EPNI .....5
				GPHF 12 G03-G03 EPNI .....5
				GPHF 12 G04-G04 EPNI .....5

\*Single G Thread: Rc = BSPP, R = BSPT

Model (ØD-R)				
	ØD (Inch) - R (NPT) Bag Qty	ØD (Metric) - R (BSPT) Bag Qty	ØD (Metric) - R (BSPP) Bag Qty	
<b>POL</b> HEX HOLED BANJO 	POL 5/32-N01U EPNI.....10	GPOL 0401 EPNI .....10	GPOL 04G01 EPNI .....10	
	POL 5/32-U10U EPNI.....10	GPOL 0402 EPNI .....10	GPOL 06G01 EPNI .....10	
	POL 3/16-N01 EPNI.....10	GPOL 04M5 EPNI .....10	GPOL 06G02 EPNI .....10	
	POL 3/16-N02 EPNI.....10	GPOL 0601 EPNI .....10	GPOL 08G01 EPNI .....10	
	POL 3/16-N03 EPNI.....10	GPOL 0602 EPNI .....10	GPOL 08G02 EPNI .....10	
	POL 3/16-U10U EPNI.....10	GPOL 0603 EPNI .....5	GPOL 08G03 EPNI .....5	
	POL 1/4-N01U EPNI.....10	GPOL 06M5 EPNI .....10	GPOL 10G02 EPNI .....5	
	POL 1/4-N02U EPNI.....10	GPOL 0801 EPNI .....10	GPOL 1202 EPNI .....5	
	POL 1/4-N03U EPNI.....5	GPOL 0802 EPNI .....10	GPOL 12G03 EPNI .....5	
	POL 1/4-U10U EPNI.....10	GPOL 0803 EPNI .....5	GPOL 12G04 EPNI .....5	
	POL 5/16-N01U EPNI.....10	GPOL 0804 EPNI .....5		
	POL 5/16-N02U EPNI.....10	GPOL 1002 EPNI .....5		
	POL 5/16-N03U EPNI.....5	GPOL 1003 EPNI .....5		
	POL 3/8-N02U EPNI.....5	GPOL 1004 EPNI .....5		
	POL 3/8-N03U EPNI.....5	GPOL 1203 EPNI .....5		
	POL 3/8-N04U EPNI.....5	GPOL 1204 EPNI .....5		
	POL 1/2-N03U EPNI.....5			
	POL 1/2-N04U EPNI.....5			

### Model (ØD-R)

	ØD (Inch) - R (NPT) Bag Qty	ØD (Metric) - R (BSPT) Bag Qty	ØD (Metric) -R (BSPP) Bag Qty
<b>PA</b> DUAL MALE BANJO  	PA 5/32-U10U EPNI .....10	GPA 0401 EPNI .....10	GPA 04G01 EPNI .....10
	PA 3/16-N01U EPNI .....10	GPA 0402 EPNI .....10	GPA 04G02 EPNI .....10
	PA 1/4-N01U EPNI .....10	GPA 0403 EPNI .....5	GPA 04G03 EPNI .....5
	PA 5/16-N02U EPNI .....5	GPA 04M5 EPNI .....10	GPA 06G01 EPNI .....10
	PA 3/8-N03U EPNI .....5	GPA 0601 EPNI .....10	GPA 06G02 EPNI .....10
	PA 1/2-N04U EPNI .....5	GPA 0602 EPNI .....10	GPA 06G03 EPNI .....5
		GPA 0603 EPNI .....5	GPA 08G01 EPNI .....5
		GPA 0801 EPNI .....5	GPA 08G02 EPNI .....5
		GPA 0802 EPNI .....5	GPA 08G03 EPNI .....5
		GPA 0803 EPNI .....5	GPA 08G04 EPNI .....5
		GPA 0804 EPNI .....5	GPA 10G02 EPNI .....5
		GPA 1002 EPNI .....5	GPA 10G03 EPNI .....5
		GPA 1003 EPNI .....5	GPA 10G04 EPNI .....5
		GPA 1004 EPNI .....5	GPA 12G03 EPNI .....5
		GPA 1203 EPNI .....5	GPA 12G04 EPNI .....5
		GPA 1204 EPNI .....5	

### Model (ØD-R)

	ØD (Inch) - R (NPT) Bag Qty	ØD (Metric) - R (BSPT) Bag Qty	ØD (Metric) -R (BSPP) Bag Qty
<b>PAF</b> DUAL FEMALE BANJO  	PAF 5/32-U10U EPNI .....10	GPAF 04M5 EPNI .....10	GPAF 06G01 EPNI .....10
	PAF 3/16-N01U EPNI .....10	GPAF 0601 EPNI .....10	GPAF 08G02 EPNI .....5
	PAF 1/4-N01U EPNI .....10	GPAF 0802 EPNI .....5	GPAF 10G03 EPNI .....5
	PAF 5/16-N02U EPNI .....5	GPAF 1003 EPNI .....5	GPAF 12G04 EPNI .....5
	PAF 3/8-N03U EPNI .....5	GPAF 1204 EPNI .....5	
	PAF 1/2-N04U EPNI .....5		

### Model (ØD-R)

<b>PH(2)</b> DOUBLE UNIVERSAL ELBOW			
ØD (Metric) - R (BSPT) Bag Qty	ØD (Metric) -R (BSPP) Bag Qty		
GPH 0401(2) EPNI ..... 5	GPH 04G01(2) EPNI ..... 10		
GPH 0402(2) EPNI ..... 5	GPH 04G02(2) EPNI ..... 5		
GPH 0403(2) EPNI ..... 5	GPH 04G03(2) EPNI ..... 5		
GPH 0601(2) EPNI ..... 5	GPH 06G01(2) EPNI ..... 5		
GPH 0602(2) EPNI ..... 5	GPH 06G02(2) EPNI ..... 5		
GPH 0603(2) EPNI ..... 5	GPH 06G03(2) EPNI ..... 5		
GPH 0801(2) EPNI ..... 5	GPH 08G01(2) EPNI ..... 5		
GPH 0802(2) EPNI ..... 5	GPH 08G02(2) EPNI ..... 5		
GPH 0803(2) EPNI ..... 5	GPH 08G03(2) EPNI ..... 5		
GPH 0804(2) EPNI ..... 5	GPH 08G04(2) EPNI ..... 5		
GPH 1002(2) EPNI ..... 5	GPH 10G02(2) EPNI ..... 5		
GPH 1003(2) EPNI ..... 5	GPH 10G03(2) EPNI ..... 5		
GPH 1004(2) EPNI ..... 5	GPH 10G04(2) EPNI ..... 5		
GPH 1202(2) EPNI ..... 3	GPH 12G03(2) EPNI ..... 3		
GPH 1203(2) EPNI ..... 3	GPH 12G04(2) EPNI ..... 3		
GPH 1204(2) EPNI ..... 3			

### Model (ØD-R)

<b>PH(3)</b> TRIPLE UNIVERSAL ELBOW			
ØD (Metric) - R (BSPT) Bag Qty	ØD (Metric) -R (BSPP) Bag Qty		
GPH 0401(3) EPNI ..... 5	GPH 04G01(3) EPNI ..... 5		
GPH 0402(3) EPNI ..... 5	GPH 04G02(3) EPNI ..... 5		
GPH 0403(3) EPNI ..... 5	GPH 04G03(3) EPNI ..... 5		
GPH 0601(3) EPNI ..... 5	GPH 06G01(3) EPNI ..... 5		
GPH 0602(3) EPNI ..... 5	GPH 06G02(3) EPNI ..... 5		
GPH 0603(3) EPNI ..... 5	GPH 06G03(3) EPNI ..... 5		
GPH 0801(3) EPNI ..... 5	GPH 0801(3) EPNI ..... 5		
GPH 0802(3) EPNI ..... 5	GPH 0802(3) EPNI ..... 5		
GPH 0803(3) EPNI ..... 5	GPH 0803(3) EPNI ..... 5		
GPH 0804(3) EPNI ..... 5	GPH 0804(3) EPNI ..... 5		
GPH 1002(3) EPNI ..... 4	GPH 10G02(3) EPNI ..... 4		
GPH 1003(3) EPNI ..... 4	GPH 10G03(3) EPNI ..... 4		
GPH 1004(3) EPNI ..... 4	GPH 10G04(3) EPNI ..... 4		
GPH 1202(3) EPNI ..... 3	GPH 12G03(3) EPNI ..... 3		
GPH 1203(3) EPNI ..... 3	GPH 12G04(3) EPNI ..... 3		
GPH 1204(3) EPNI ..... 3			

### Model (ØD-R)

<b>PA(2)</b> DOUBLE BRANCH A			
ØD (Metric) - R (BSPT) Bag Qty	ØD (Metric) -R (BSPP) Bag Qty		
GPA 0401(2) EPNI ..... 5	GPA 04G01(2) EPNI ..... 5		
GPA 0402(2) EPNI ..... 5	GPA 04G02(2) EPNI ..... 5		
GPA 0403(2) EPNI ..... 5	GPA 04G03(2) EPNI ..... 5		
GPA 04M5(2) EPNI ..... 5	GPA 06G01(2) EPNI ..... 5		
GPA 0601(2) EPNI ..... 5	GPA 06G02(2) EPNI ..... 5		
GPA 0602(2) EPNI ..... 5	GPA 06G03(2) EPNI ..... 5		
GPA 0603(2) EPNI ..... 5	GPA 08G01(2) EPNI ..... 5		
GPA 0801(2) EPNI ..... 5	GPA 08G02(2) EPNI ..... 5		
GPA 0802(2) EPNI ..... 5	GPA 08G03(2) EPNI ..... 5		
GPA 0803(2) EPNI ..... 5	GPA 08G04(2) EPNI ..... 5		
GPA 0804(2) EPNI ..... 5	GPA 10G02(2) EPNI ..... 4		
GPA 1002(2) EPNI ..... 4	GPA 10G03(2) EPNI ..... 4		
GPA 1003(2) EPNI ..... 4	GPA 10G04(2) EPNI ..... 4		
GPA 1004(2) EPNI ..... 4	GPA 12G03(2) EPNI ..... 3		
GPA 1202(2) EPNI ..... 3	GPA 12G04(2) EPNI ..... 3		
GPA 1203(2) EPNI ..... 3			
GPA 1204(2) EPNI ..... 3			

### Model (ØD-R)

<b>PA (3)</b> TRIPLE BRANCH A			
ØD (Metric) - R (BSPT) Bag Qty	ØD (Metric) -R (BSPP) Bag Qty		
GPA 0401(3) EPNI ..... 5	GPA 04G01(3) EPNI ..... 5		
GPA 0402(3) EPNI ..... 5	GPA 04G02(3) EPNI ..... 5		
GPA 0403(3) EPNI ..... 5	GPA 04G03(3) EPNI ..... 5		
GPA 0601(3) EPNI ..... 5	GPA 06G01(3) EPNI ..... 5		
GPA 0602(3) EPNI ..... 5	GPA 06G02(3) EPNI ..... 5		
GPA 0603(3) EPNI ..... 5	GPA 06G03(3) EPNI ..... 5		
GPA 0801(3) EPNI ..... 4	GPA 08G01(3) EPNI ..... 4		
GPA 0802(3) EPNI ..... 4	GPA 08G02(3) EPNI ..... 4		
GPA 0803(3) EPNI ..... 4	GPA 08G03(3) EPNI ..... 4		
GPA 0804(3) EPNI ..... 4	GPA 08G04(3) EPNI ..... 4		
GPA 1002(3) EPNI ..... 3	GPA 10G02(3) EPNI ..... 3		
GPA 1003(3) EPNI ..... 3	GPA 10G03(3) EPNI ..... 3		
GPA 1004(3) EPNI ..... 3	GPA 10G04(3) EPNI ..... 3		
GPA 1202(3) EPNI ..... 3	GPA 12G03(3) EPNI ..... 3		
GPA 1203(3) EPNI ..... 3	GPA 12G04(3) EPNI ..... 3		
GPA 1204(3) EPNI ..... 3			

### Model (ØD-R)

	ØD (Inch) - R (NPT) Bag Qty	ØD (Inch) - R (BSPT) Bag Qty	ØD (Metric) - R (BSPT) Bag Qty	ØD (Metric) -R (BSPP) Bag Qty
<b>PT</b> <b>MALE BRANCH TEE</b>  	PT 5/32-N01U EPNI .....10	PT 5/32-R01 EPNI .....10	GPT 0401 EPNI .....10	GPT 04G01 EPNI .....10
	PT 5/32-N02U EPNI .....10	PT 5/32-R02 EPNI .....10	GPT 0402 EPNI .....10	GPT 04G02 EPNI .....10
	PT 5/32-N03U EPNI .....10	PT 5/32-R03 EPNI .....10	GPT 0403 EPNI .....10	GPT 04G03 EPNI .....10
	PT 5/32-U10U EPNI .....10	PT 3/16-R01 EPNI .....10	GPT 04M5 EPNI .....10	GPT 06G01 EPNI .....10
	PT 3/16-N01U EPNI .....10	PT 3/16-R02 EPNI .....10	GPT 04M6 EPNI .....10	GPT 06G02 EPNI .....10
	PT 3/16-N02U EPNI .....10	PT 3/16-R03 EPNI .....10	GPT 0601 EPNI .....10	GPT 06G03 EPNI .....10
	PT 3/16-N03U EPNI .....10	PT 1/4-R01 EPNI .....10	GPT 0602 EPNI .....10	GPT 06G04 EPNI .....5
	PT 3/16-U10U EPNI .....10	PT 1/4-R02 EPNI .....10	GPT 0603 EPNI .....10	GPT 08G01 EPNI .....10
	PT 1/4-N01U EPNI .....10	PT 1/4-R03 EPNI .....10	GPT 0604 EPNI .....5	GPT 08G02 EPNI .....10
	PT 1/4-N02U EPNI .....10	PT 1/4-R04 EPNI .....10	GPT 06M5 EPNI .....10	GPT 08G03 EPNI .....10
	PT 1/4-N03U EPNI .....10	PT 5/16-R01 EPNI .....10	GPT 06M6 EPNI .....10	GPT 08G04 EPNI .....5
	PT 1/4-N04U EPNI .....10	PT 5/16-R02 EPNI .....10	GPT 0801 EPNI .....10	GPT 10G01 EPNI .....5
	PT 1/4-U10U EPNI .....10	PT 5/16-R03 EPNI .....5	GPT 0802 EPNI .....10	GPT 10G02 EPNI .....5
	PT 5/16-N01U EPNI .....10	PT 5/16-R04 EPNI .....5	GPT 0803 EPNI .....10	GPT 10G03 EPNI .....5
	PT 5/16-N02U EPNI .....10	PT 3/8-R01 EPNI .....5	GPT 0804 EPNI .....5	GPT 10G04 EPNI .....5
	PT 5/16-N03U EPNI .....5	PT 3/8-R02 EPNI .....5	GPT 1001 EPNI .....5	GPT 12G01 EPNI .....5
	PT 5/16-N04U EPNI .....5	PT 3/8-R03 EPNI .....5	GPT 1002 EPNI .....5	GPT 12G02 EPNI .....5
	PT 3/8-N01U EPNI .....5	PT 3/8-R04 EPNI .....5	GPT 1003 EPNI .....5	GPT 12G03 EPNI .....5
	PT 3/8-N02U EPNI .....5	PT 1/2-R01 EPNI .....5	GPT 1004 EPNI .....5	GPT 12G04 EPNI .....5
	PT 3/8-N03U EPNI .....5	PT 1/2-R02 EPNI .....5	GPT 1201 EPNI .....5	GPT 14G03 EPNI .....4
PT 3/8-N04U EPNI .....5	PT 1/2-R03 EPNI .....5	GPT 1202 EPNI .....5	GPT 14G04 EPNI .....4	
PT 1/2-N01U EPNI .....5	PT 1/2-R04 EPNI .....5	GPT 1203 EPNI .....5	GPT 16G03 EPNI .....4	
PT 1/2-N02U EPNI .....5		GPT 1204 EPNI .....5	GPT 16G04 EPNI .....4	
PT 1/2-N03U EPNI .....5		GPT 1403 EPNI .....4		
PT 1/2-N04U EPNI .....5		GPT 1404 EPNI .....4		
		GPT 1603 EPNI .....4		
		GPT 1604 EPNI .....4		

### Model (ØD-R)

	ØD (Inch) - R (NPT) Bag Qty	ØD (Inch) - R (BSPT) Bag Qty	ØD (Inch) - R (BSPT) Bag Qty	ØD (Metric) -R (BSPP) Bag Qty
<b>PST</b> <b>MALE RUN TEE</b>  	PST 5/32-N01U EPNI .....10	PST 5/32-R01 EPNI .....10	GPST 0401 EPNI .....10	GPST 04G01 EPNI .....10
	PST 5/32-N02U EPNI .....10	PST 5/32-R02 EPNI .....10	GPST 0402 EPNI .....10	GPST 04G02 EPNI .....10
	PST 5/32-U10U EPNI .....10	PST 3/16-R01 EPNI .....10	GPST 0403 EPNI .....10	GPST 04G03 EPNI .....10
	PST 3/16-N01U EPNI .....10	PST 3/16-R02 EPNI .....10	GPST 04M5 EPNI .....10	GPST 06G01 EPNI .....10
	PST 3/16-N02U EPNI .....10	PST 3/16-R03 EPNI .....10	GPST 04M6 EPNI .....10	GPST 06G02 EPNI .....10
	PST 3/16-N03U EPNI .....10	PST 1/4-R01 EPNI .....10	GPST 0601 EPNI .....10	GPST 06G03 EPNI .....10
	PST 3/16-U10U EPNI .....10	PST 1/4-R02 EPNI .....10	GPST 0602 EPNI .....10	GPST 06G04 EPNI .....5
	PST 1/4-N01U EPNI .....10	PST 1/4-R03 EPNI .....10	GPST 0603 EPNI .....10	GPST 08G01 EPNI .....10
	PST 1/4-N02U EPNI .....10	PST 1/4-R04 EPNI .....10	GPST 0604 EPNI .....5	GPST 08G02 EPNI .....10
	PST 1/4-N03U EPNI .....10	PST 5/16-R02 EPNI .....10	GPST 06M5 EPNI .....10	GPST 08G03 EPNI .....5
	PST 1/4-U10U EPNI .....10	PST 5/16-R03 EPNI .....10	GPST 06M6 EPNI .....10	GPST 08G04 EPNI .....5
	PST 5/16-N01U EPNI .....10	PST 5/16-R04 EPNI .....5	GPST 0801 EPNI .....10	GPST 10G01 EPNI .....5
	PST 5/16-N02U EPNI .....10	PST 3/8-R01 EPNI .....5	GPST 0802 EPNI .....10	GPST 10G02 EPNI .....5
	PST 5/16-N03U EPNI .....10	PST 3/8-R02 EPNI .....5	GPST 0803 EPNI .....5	GPST 10G03 EPNI .....5
	PST 5/16-N04U EPNI .....5	PST 3/8-R03 EPNI .....5	GPST 0804 EPNI .....5	GPST 10G04 EPNI .....5
	PST 3/8-N01U EPNI .....5	PST 3/8-R04 EPNI .....5	GPST 1001 EPNI .....5	GPST 12G01 EPNI .....5
	PST 3/8-N02U EPNI .....5	PST 1/2-R02 EPNI .....5	GPST 1002 EPNI .....5	GPST 12G02 EPNI .....5
	PST 3/8-N03U EPNI .....5	PST 1/2-R03 EPNI .....5	GPST 1003 EPNI .....5	GPST 12G03 EPNI .....5
	PST 3/8-N04U EPNI .....5	PST 1/2-R04 EPNI .....5	GPST 1004 EPNI .....5	GPST 12G04 EPNI .....5
	PST 1/2-N02U EPNI .....5		GPST 1201 EPNI .....5	GPST 14G03 EPNI .....4
PST 1/2-N03U EPNI .....5		GPST 1202 EPNI .....5	GPST 14G04 EPNI .....4	
PST 1/2-N04U EPNI .....5		GPST 1203 EPNI .....5	GPST 16G03 EPNI .....4	
		GPST 1204 EPNI .....5	GPST 16G04 EPNI .....4	
		GPST 1403 EPNI .....4		
		GPST 1404 EPNI .....4		
		GPST 1603 EPNI .....4		
		GPST 1604 EPNI .....4		

### Model (ØD-R)

	ØD (Inch) - R (NPT) Bag Qty	ØD (Inch) - R (BSPT) Bag Qty	ØD (Metric) - R (BSPT) Bag Qty	ØD (Metric) -R (BSPP) Bag Qty
<b>PWT</b> <b>MALE Y</b>  	PWT 5/32-N01U EPNI .....10	PWT 5/32-R01 EPNI .....10	GPWT 0401 EPNI .....10	GPWT 04G01 EPNI .....10
	PWT 5/32-N02U EPNI .....10	PWT 5/32-R02 EPNI .....10	GPWT 0402 EPNI .....10	GPWT 04G02 EPNI .....10
	PWT 5/32-U10U EPNI .....10	PWT 3/16-R01 EPNI .....10	GPWT 0403 EPNI .....10	GPWT 04G03 EPNI .....10
	PWT 3/16-N01U EPNI .....10	PWT 3/16-R02 EPNI .....10	GPWT 04M5 EPNI .....10	GPWT 06G01 EPNI .....10
	PWT 3/16-N02U EPNI .....10	PWT 3/16-R03 EPNI .....10	GPWT 04M6 EPNI .....10	GPWT 06G02 EPNI .....10
	PWT 3/16-N03U EPNI .....10	PWT 1/4-R01 EPNI .....10	GPWT 0601 EPNI .....10	GPWT 06G03 EPNI .....5
	PWT 3/16-U10U EPNI .....10	PWT 1/4-R02 EPNI .....10	GPWT 0602 EPNI .....10	GPWT 06G04 EPNI .....5
	PWT 1/4-N01U EPNI .....10	PWT 1/4-R03 EPNI .....10	GPWT 0603 EPNI .....5	GPWT 08G01 EPNI .....10
	PWT 1/4-N02U EPNI .....10	PWT 5/16-R01 EPNI .....10	GPWT 0604 EPNI .....5	GPWT 08G02 EPNI .....10
	PWT 1/4-N03U EPNI .....10	PWT 5/16-R02 EPNI .....10	GPWT 06M5 EPNI .....10	GPWT 08G03 EPNI .....5
	PWT 1/4-U10U EPNI .....10	PWT 5/16-R03 EPNI .....5	GPWT 06M6 EPNI .....10	GPWT 08G04 EPNI .....5
	PWT 5/16-N01U EPNI .....10	PWT 5/16-R04 EPNI .....5	GPWT 0801 EPNI .....10	GPWT 10G01 EPNI .....5
	PWT 5/16-N02U EPNI .....10	PWT 3/8-R01 EPNI .....5	GPWT 0802 EPNI .....10	GPWT 10G02 EPNI .....5
	PWT 5/16-N03U EPNI .....5	PWT 3/8-R02 EPNI .....5	GPWT 0803 EPNI .....5	GPWT 10G03 EPNI .....5
	PWT 5/16-N04U EPNI .....5	PWT 3/8-R03 EPNI .....5	GPWT 0804 EPNI .....5	GPWT 10G04 EPNI .....5
	PWT 3/8-N01U EPNI .....5	PWT 3/8-R04 EPNI .....5	GPWT 1001 EPNI .....5	GPWT 12G01 EPNI .....5
	PWT 3/8-N02U EPNI .....5	PWT 1/2-R02 EPNI .....5	GPWT 1002 EPNI .....5	GPWT 12G02 EPNI .....5
	PWT 3/8-N03U EPNI .....5	PWT 1/2-R03 EPNI .....5	GPWT 1003 EPNI .....5	GPWT 12G03 EPNI .....5
	PWT 3/8-N04U EPNI .....5	PWT 1/2-R04 EPNI .....5	GPWT 1004 EPNI .....5	GPWT 12G04 EPNI .....5
	PWT 1/2-N02U EPNI .....5		GPWT 1201 EPNI .....5	
PWT 1/2-N03U EPNI .....5		GPWT 1202 EPNI .....5		
PWT 1/2-N04U EPNI .....5		GPWT 1203 EPNI .....5		
		GPWT 1204 EPNI .....5		





Model (ØD-R)				
	ØD (Inch) - R (NPT)	Bag Qty	ØD (Inch) - R (BSPT)	Bag Qty
<b>PXT</b> MALE DOUBLE Y 	PXT 5/32-N01U EPNI.....5		PXT 1/4-R01 EPNI .....5	
	PXT 5/32-N02U EPNI.....5		PXT 1/4-R02 EPNI .....5	
	PXT 1/4-N01U EPNI.....5			
	PXT 1/4-N02U EPNI.....5			
	ØD (Metric) - R (BSPT)	Bag Qty	ØD (Metric) -R (BSPP)	Bag Qty
	GPXT 0401 EPNI .....5		GPXT 04G01 EPNI.....5	
	GPXT 0402 EPNI .....5		GPXT 04G02 EPNI.....5	
	GPXT 0601 EPNI .....5		GPXT 06G01 EPNI.....5	
	GPXT 0602 EPNI .....5		GPXT 06G02 EPNI.....5	



Model (ØD-R)	
	ØD (Metric) -R (BSPP)
<b>PGT(1)</b> SINGLE UNIVERSAL TEE 	PGT 04G01(1)EPNI
	PGT 06G01(1)EPNI
	PGT 06G02(1)EPNI
	PGT 08G01(1)EPNI
	PGT 08G02(1)EPNI
	PGT 08G03(1)EPNI
	PGT 10G02(1)EPNI
	PGT 10G03(1)EPNI
	PGT 12G03(1)EPNI
	PGT 12G04(1)EPNI



Model (ØD-R)						
	ØD (Inch) - R (NPT)	Bag Qty	ØD (Metric) - R (BSPT)	Bag Qty	ØD (Metric) - R (BSPP)	Bag Qty
<b>PTF</b> FEMALE BRANCH TEE 	PTF 5/32-N01U EPNI.....10		GPTF 0401 EPNI.....10		GPTF 04G01 EPNI.....10	
	PTF 5/32-N02U EPNI.....10		GPTF 0402 EPNI.....10		GPTF 04G02 EPNI.....10	
	PTF 5/32-U10U EPNI.....10		GPTF 04M5 EPNI.....10		GPTF 06G01 EPNI.....10	
	PTF 3/16-N01U EPNI.....10		GPTF 04M6 EPNI.....10		GPTF 06G02 EPNI.....10	
	PTF 3/16-N02U EPNI.....10		GPTF 0601 EPNI.....10		GPTF 06G03 EPNI.....5	
	PTF 3/16-U10U EPNI.....10		GPTF 0602 EPNI.....10		GPTF 08G01 EPNI.....10	
	PTF 1/4-N01U EPNI.....10		GPTF 0603 EPNI.....5		GPTF 08G02 EPNI.....10	
	PTF 1/4-N02U EPNI.....10		GPTF 06M5 EPNI.....10		GPTF 08G03 EPNI.....5	
	PTF 1/4-N03U EPNI.....10		GPTF 06M6 EPNI.....10		GPTF 10G02 EPNI.....5	
	PTF 1/4-U10U EPNI.....10		GPTF 0801 EPNI.....10		GPTF 10G03 EPNI.....5	
	PTF 5/16-N01U EPNI.....10		GPTF 0802 EPNI.....10		GPTF 10G04 EPNI.....5	
	PTF 5/16-N02U EPNI.....10		GPTF 0803 EPNI.....5		GPTF 12G02 EPNI.....5	
	PTF 5/16-N03U EPNI.....5		GPTF 1002 EPNI.....5		GPTF 12G03 EPNI.....5	
	PTF 3/8-N02U EPNI.....5		GPTF 1003 EPNI.....5		GPTF 12G04 EPNI.....5	
	PTF 3/8-N03U EPNI.....5		GPTF 1004 EPNI.....5			
	PTF 3/8-N04U EPNI.....5					



Model (ØD-R)	
	ØD (Metric) -R (BSPP)
<b>PGT(2)</b> DOUBLE UNIVERSAL TEE 	PGT 04G01(2)EPNI
	PGT 06G01(2)EPNI
	PGT 06G02(2)EPNI
	PGT 08G01(2)EPNI
	PGT 08G02(2)EPNI
	PGT 08G03(2)EPNI
	PGT 10G02(2)EPNI
	PGT 10G03(2)EPNI
	PGT 12G03(2)EPNI
	PGT 12G04(2)EPNI



Model (ØD-R)	
	ØD (Metric) -R (BSPP)
<b>PGT(3)</b> TRIPLE UNIVERSAL TEE 	PGT 04G01(3)EPNI
	PGT 06G01(3)EPNI
	PGT 06G02(3)EPNI
	PGT 08G01(3)EPNI
	PGT 08G02(3)EPNI
	PGT 08G03(3)EPNI
	PGT 10G02(3)EPNI
	PGT 10G03(3)EPNI
	PGT 12G03(3)EPNI
	PGT 12G04(3)EPNI



Model (ØD-R)								
	ØD (Inch) - R (NPT)	Bag Qty	ØD (Inch) - R (BSPT)	Bag Qty	ØD (Metric) - R (BSPT)	Bag Qty	ØD (Metric) -R (BSPP)	Bag Qty
<b>PMF</b> BULKHEAD FEMALE STRAIGHT 	PMF 5/32-N01U EPNI.....10		PMF 5/32-Rc01 EPNI.....10		GPMF 0401 EPNI.....10		GPMF 04G01 EPNI.....10	
	PMF 3/16-N01U EPNI.....10		PMF 5/32-Rc02 EPNI.....10		GPMF 0402 EPNI.....10		GPMF 04G02 EPNI.....10	
	PMF 3/16-N02U EPNI.....10		PMF 5/32-Rc03 EPNI.....10		GPMF 0403 EPNI.....10		GPMF 04G03 EPNI.....10	
	PMF 1/4-N01U EPNI.....10		PMF 3/16-Rc01 EPNI.....10		GPMF 0601 EPNI.....10		GPMF 06G01 EPNI.....10	
	PMF 1/4-N02U EPNI.....10		PMF 3/16-Rc02 EPNI.....10		GPMF 0602 EPNI.....10		GPMF 06G02 EPNI.....10	
	PMF 5/16-N01U EPNI.....10		PMF 1/4-Rc01 EPNI.....10		GPMF 0603 EPNI.....10		GPMF 06G03 EPNI.....10	
	PMF 5/16-N02U EPNI.....10		PMF 1/4-Rc02 EPNI.....10		GPMF 0801 EPNI.....10		GPMF 08G01 EPNI.....10	
	PMF 5/16-N03U EPNI.....10		PMF 1/4-Rc03 EPNI.....10		GPMF 0802 EPNI.....10		GPMF 08G02 EPNI.....10	
	PMF 3/8-N02U EPNI.....5		PMF 5/16-Rc01 EPNI.....10		GPMF 0803 EPNI.....10		GPMF 08G03 EPNI.....10	
	PMF 3/8-N03U EPNI.....5		PMF 5/16-Rc02 EPNI.....10		GPMF 0804 EPNI.....5		GPMF 08G04 EPNI.....5	
	PMF 1/2-N02U EPNI.....5		PMF 5/16-Rc03 EPNI.....10		GPMF 1001 EPNI.....5		GPMF 10G01 EPNI.....5	
	PMF 1/2-N03U EPNI.....5		PMF 5/16-Rc04 EPNI.....5		GPMF 1002 EPNI.....5		GPMF 10G02 EPNI.....5	
	PMF 1/2-N04U EPNI.....5		PMF 3/8-Rc01 EPNI.....5		GPMF 1003 EPNI.....5		GPMF 10G03 EPNI.....5	
			PMF 3/8-Rc02 EPNI.....5		GPMF 1004 EPNI.....5		GPMF 10G04 EPNI.....5	
			PMF 3/8-Rc03 EPNI.....5		GPMF 1201 EPNI.....5		GPMF 12G01 EPNI.....5	
			PMF 3/8-Rc04 EPNI.....5		GPMF 1202 EPNI.....5		GPMF 12G02 EPNI.....5	
			PMF 1/2-Rc01 EPNI.....5		GPMF 1203 EPNI.....5		GPMF 12G03 EPNI.....5	
			PMF 1/2-Rc02 EPNI.....5		GPMF 1204 EPNI.....5		GPMF 12G04 EPNI.....5	
			PMF 1/2-Rc03 EPNI.....5					
			PMF 1/2-Rc04 EPNI.....5					

Model (ØD)							
	ØD (Inch)	Bag Qty	ØD (Inch)	Bag Qty	ØD (Inch)	Bag Qty	
<b>PMM</b> BULKHEAD UNION 	PMM 5/32 EPNI.....10		<b>PPM</b> BULKHEAD UNION PLASTIC 	PPM 5/32.....10	<b>PLM</b> BULKHEAD UNION ELBOW PLASTIC 	PLM 5/32.....10	
	PMM 3/16 EPNI.....10			PPM 3/16.....10		PLM 3/16.....10	
	PMM 1/4 EPNI.....10			PPM 1/4.....10		PLM 1/4.....10	
	PMM 5/16 EPNI.....10			PPM 5/16.....10		PLM 5/16.....10	
	PMM 3/8 EPNI.....5			PPM 3/8.....5		PLM 3/8.....5	
PMM 1/2 EPNI.....5		PPM 1/2.....5	PLM 1/2.....5				
	ØD (Metric)	Bag Qty		ØD (Metric)	Bag Qty	ØD (Metric)	Bag Qty
	GPMM 04 EPNI.....10			GPPM 04.....10		GPLM 04.....10	
	GPMM 06 EPNI.....10			GPPM 06.....10		GPLM 06.....10	
	GPMM 08 EPNI.....10			GPPM 08.....10		GPLM 08.....5	
	GPMM 10 EPNI.....5			GPPM 10.....5		GPLM 10.....5	
	GPMM 12 EPNI.....5			GPPM 12.....5		GPLM 12.....5	

Model (ØD)							
ØD (Inch)		Bag Qty	ØD (Inch)		Bag Qty		
<b>PUC</b> UNION STRAIGHT 	PUC 5/32.....	10	<b>PUL</b> UNION ELBOW 	PUL 5/32.....	10		
	PUC 3/16.....	10		PUL 3/16.....	10		
	PUC 1/4.....	10		PUL 1/4.....	10		
	PUC 5/16.....	10		PUL 5/16.....	10		
	PUC 3/8.....	10		PUL 3/8.....	5		
	PUC 1/2.....	5		PUL 1/2.....	5		
	PUC 1/2-1/4.....	5					
	<b>ØD (Metric)</b>			<b>Bag Qty</b>	<b>ØD (Metric)</b>		<b>Bag Qty</b>
	GPUC 04.....	10		GPUL 04.....	10		
	GPUC 06.....	10		GPUL 06.....	10		

Model (ØD)			Model (ØD-ØD2)				
ØD (Inch)		Bag Qty	ØD (Inch)		Bag Qty		
<b>PY</b> UNION Y 	PY 5/32.....	10	<b>PZA</b> UNION CROSS 	PZA 5/32.....	10		
	PY 3/16.....	10		PZA 3/16.....	10		
	PY 1/4.....	10		PZA 1/4.....	10		
	PY 5/16.....	10		PZA 5/16.....	5		
	PY 3/8.....	5		PZA 3/8.....	5		
	PY 1/2.....	5		PZA 1/2.....	5		
	<b>ØD (Metric)</b>			<b>Bag Qty</b>	<b>ØD (Metric)</b>		<b>Bag Qty</b>
	GPY 04.....	10		GPZA 04.....	10		
	GPY 06.....	10		GPZA 06.....	10		
	GPY 08.....	10		GPZA 08.....	5		

Model (ØD-ØD2)					
ØD(Inch) - ØD2(Inch)		Bag Qty	ØD(Inch) - ØD2(Inch)		Bag Qty
<b>PG</b> REDUCER 	PG 3/16-5/32.....	10	<b>PUG</b> REDUCER TEE 	PUG 1/4-5/32.....	10
	PG 1/4-5/32.....	10		PUG 5/16-5/32.....	10
	PG 1/4-3/16.....	10		PUG 5/16-1/4.....	10
	PG 5/16-5/32.....	10		PUG 3/8-1/4.....	5
	PG 5/16-1/4.....	10		PUG 3/8-5/16.....	5
	PG 3/8-5/16.....	10		PUG 1/2-5/16.....	5
	PG 3/8-1/4.....	10		PUG 1/2-3/8.....	5
	PG 1/2-5/16.....	5			
	PG 1/2-3/8.....	5			
	<b>ØD(Metric) - ØD2(Metric)</b>			<b>Bag Qty</b>	<b>ØD(Metric) - ØD2(Metric)</b>
GPG 0403.....	10	GPUG 0604.....	10		

Model (ØD-ØD2)							
ØD(Inch) - ØD2(Inch)		Bag Qty	ØD(Inch) - ØD2(Inch)		Bag Qty		
<b>PKD</b> MALE REDUCER TRIPLE BRANCH 	PKD 3/16-5/32-N01U EPNI ..5	5	<b>PKG</b> REDUCER TRIPLE BRANCH 	PKG 3/16-5/32.....	5		
	PKD 1/4-5/32-N01U EPNI ...5	5		PKG 5/16-5/32.....	5		
	PKD 5/16-5/32-N02U EPNI ..5	5		PKG 5/16-3/16.....	5		
	PKD 5/16-3/16-N02U EPNI ..5	5		PKG 5/16-1/4.....	5		
	PKD 5/16-1/4-N02U EPNI ...5	5		PKG 3/8-1/4.....	5		
	PKD 5/16-1/4-N03U EPNI ...5	5		PKG 3/8-5/16.....	5		
	PKD 3/8-1/4-N02U EPNI .....5	5					
	PKD 3/8-5/16-N03U EPNI .....5	5					
	<b>ØD(Metric) - ØD2(Metric)</b>			<b>Bag Qty</b>	<b>ØD(Metric) - ØD2(Metric)</b>		<b>Bag Qty</b>
	GPKD 0604-01 EPNI.....5	5		GPKG 0604.....	5		

### Model (ØD-R)

PCJ PLUG-IN MALE	ØD (Inch) - R (NPT)		ØD (Metric) -R (BSPT)		ØD (Metric) -R (NPT)	
	ØD (Inch)	Bag Qty	ØD (Metric)	Bag Qty	ØD (Metric)	Bag Qty
	PCJ 5/32-N01 EPNI	10	GPCJ 0401 EPNI	10	PCJ 04-N01 EPNI	10
	PCJ 5/32-N02 EPNI	10	GPCJ 0402 EPNI	10	PCJ 04-N02 EPNI	10
	PCJ 5/32-U10 EPNI	10	GPCJ 04M5 EPNI	10	PCJ 04-U10 EPNI	10
	PCJ 3/16-N01 EPNI	10	GPCJ 0601 EPNI	10	PCJ 06-N01 EPNI	10
	PCJ 3/16-N02 EPNI	10	GPCJ 0602 EPNI	10	PCJ 06-N02 EPNI	10
	PCJ 3/16-U10 EPNI	10	GPCJ 0603 EPNI	10	PCJ 06-N03 EPNI	10
	PCJ 1/4-N01 EPNI	10	GPCJ 06M5 EPNI	10	PCJ 06-U10 EPNI	10
	PCJ 1/4-N02 EPNI	10	GPCJ 0801 EPNI	10	PCJ 08-N01 EPNI	10
	PCJ 1/4-N03 EPNI	10	GPCJ 0802 EPNI	10	PCJ 08-N02 EPNI	10
	PCJ 1/4-U10 EPNI	10	GPCJ 0803 EPNI	10	PCJ 08-N03 EPNI	10
	PCJ 5/16-N02 EPNI	10	GPCJ 1002 EPNI	5	PCJ 10-N02 EPNI	5
	PCJ 5/16-N03 EPNI	10	GPCJ 1003 EPNI	5	PCJ 10-N03 EPNI	5
	PCJ 3/8-N02 EPNI	5	GPCJ 1004 EPNI	5	PCJ 10-N04 EPNI	5
	PCJ 3/8-N03 EPNI	5	GPCJ 1202 EPNI	5	PCJ 12-N02 EPNI	5
	PCJ 3/8-N04 EPNI	5	GPCJ 1203 EPNI	5	PCJ 12-N03 EPNI	5
	PCJ 1/2-N02 EPNI	5	GPCJ 1204 EPNI	5	PCJ 12-N04 EPNI	5
	PCJ 1/2-N03 EPNI	5	GPCJ 1403 EPNI	4		
	PCJ 1/2-N04 EPNI	5	GPCJ 1404 EPNI	4		
			GPCJ 1603 EPNI	4		
			GPCJ 1604 EPNI	4		





### Model (ØD)

PLJ PLUG-IN ELBOW	PLLJ PLUG-IN EXTENDED ELBOW	PLJ45 PLUG-IN 45 ELBOW	PLLJ45 PLUG-IN EXTENDED 45 ELBOW																																																																																																																								
																																																																																																																											
<table border="1"> <thead> <tr> <th>ØD(Inch)</th> <th>Bag Qty</th> <th>ØD(Metric)</th> <th>Bag Qty</th> </tr> </thead> <tbody> <tr><td>PLJ 5/32</td><td>10</td><td>GPLJ 04</td><td>10</td></tr> <tr><td>PLJ 3/16</td><td>10</td><td>GPLJ 06</td><td>10</td></tr> <tr><td>PLJ 1/4</td><td>10</td><td>GPLJ 08</td><td>10</td></tr> <tr><td>PLJ 5/16</td><td>10</td><td>GPLJ 10</td><td>5</td></tr> <tr><td>PLJ 3/8</td><td>10</td><td>GPLJ 12</td><td>5</td></tr> <tr><td>PLJ 1/2</td><td>5</td><td>GPLJ 14</td><td>5</td></tr> <tr><td></td><td></td><td>GPLJ 16</td><td>5</td></tr> </tbody> </table>	ØD(Inch)	Bag Qty	ØD(Metric)	Bag Qty	PLJ 5/32	10	GPLJ 04	10	PLJ 3/16	10	GPLJ 06	10	PLJ 1/4	10	GPLJ 08	10	PLJ 5/16	10	GPLJ 10	5	PLJ 3/8	10	GPLJ 12	5	PLJ 1/2	5	GPLJ 14	5			GPLJ 16	5	<table border="1"> <thead> <tr> <th>ØD(Inch)</th> <th>Bag Qty</th> <th>ØD(Metric)</th> <th>Bag Qty</th> </tr> </thead> <tbody> <tr><td>PLLJ 5/32</td><td>10</td><td>GPLLJ 04</td><td>10</td></tr> <tr><td>PLLJ 3/16</td><td>10</td><td>GPLLJ 06</td><td>10</td></tr> <tr><td>PLLJ 1/4</td><td>10</td><td>GPLLJ 08</td><td>10</td></tr> <tr><td>PLLJ 5/16</td><td>10</td><td>GPLLJ 10</td><td>5</td></tr> <tr><td>PLLJ 3/8</td><td>5</td><td>GPLLJ 12</td><td>5</td></tr> <tr><td>PLLJ 1/2</td><td>5</td><td>GPLLJ 14</td><td>5</td></tr> <tr><td></td><td></td><td>GPLLJ 16</td><td>5</td></tr> </tbody> </table>	ØD(Inch)	Bag Qty	ØD(Metric)	Bag Qty	PLLJ 5/32	10	GPLLJ 04	10	PLLJ 3/16	10	GPLLJ 06	10	PLLJ 1/4	10	GPLLJ 08	10	PLLJ 5/16	10	GPLLJ 10	5	PLLJ 3/8	5	GPLLJ 12	5	PLLJ 1/2	5	GPLLJ 14	5			GPLLJ 16	5	<table border="1"> <thead> <tr> <th>ØD(Inch)</th> <th>Bag Qty</th> <th>ØD(Metric)</th> <th>Bag Qty</th> </tr> </thead> <tbody> <tr><td>PLJ45 5/32</td><td>10</td><td>GPLJ45 04</td><td>10</td></tr> <tr><td>PLJ45 3/16</td><td>10</td><td>GPLJ45 06</td><td>10</td></tr> <tr><td>PLJ45 1/4</td><td>10</td><td>GPLJ45 08</td><td>10</td></tr> <tr><td>PLJ45 5/16</td><td>10</td><td>GPLJ45 10</td><td>5</td></tr> <tr><td>PLJ45 3/8</td><td>10</td><td>GPLJ45 12</td><td>5</td></tr> <tr><td>PLJ45 1/2</td><td>5</td><td></td><td></td></tr> </tbody> </table>	ØD(Inch)	Bag Qty	ØD(Metric)	Bag Qty	PLJ45 5/32	10	GPLJ45 04	10	PLJ45 3/16	10	GPLJ45 06	10	PLJ45 1/4	10	GPLJ45 08	10	PLJ45 5/16	10	GPLJ45 10	5	PLJ45 3/8	10	GPLJ45 12	5	PLJ45 1/2	5			<table border="1"> <thead> <tr> <th>ØD(Inch)</th> <th>Bag Qty</th> <th>ØD(Metric)</th> <th>Bag Qty</th> </tr> </thead> <tbody> <tr><td>PLLJ45 5/32</td><td>10</td><td>GPLLJ45 04</td><td>10</td></tr> <tr><td>PLLJ45 3/16</td><td>10</td><td>GPLLJ45 06</td><td>10</td></tr> <tr><td>PLLJ45 1/4</td><td>10</td><td>GPLLJ45 08</td><td>10</td></tr> <tr><td>PLLJ45 5/16</td><td>10</td><td>GPLLJ45 10</td><td>5</td></tr> <tr><td>PLLJ45 3/8</td><td>5</td><td>GPLLJ45 12</td><td>5</td></tr> <tr><td>PLLJ45 1/2</td><td>5</td><td></td><td></td></tr> </tbody> </table>	ØD(Inch)	Bag Qty	ØD(Metric)	Bag Qty	PLLJ45 5/32	10	GPLLJ45 04	10	PLLJ45 3/16	10	GPLLJ45 06	10	PLLJ45 1/4	10	GPLLJ45 08	10	PLLJ45 5/16	10	GPLLJ45 10	5	PLLJ45 3/8	5	GPLLJ45 12	5	PLLJ45 1/2	5		
ØD(Inch)	Bag Qty	ØD(Metric)	Bag Qty																																																																																																																								
PLJ 5/32	10	GPLJ 04	10																																																																																																																								
PLJ 3/16	10	GPLJ 06	10																																																																																																																								
PLJ 1/4	10	GPLJ 08	10																																																																																																																								
PLJ 5/16	10	GPLJ 10	5																																																																																																																								
PLJ 3/8	10	GPLJ 12	5																																																																																																																								
PLJ 1/2	5	GPLJ 14	5																																																																																																																								
		GPLJ 16	5																																																																																																																								
ØD(Inch)	Bag Qty	ØD(Metric)	Bag Qty																																																																																																																								
PLLJ 5/32	10	GPLLJ 04	10																																																																																																																								
PLLJ 3/16	10	GPLLJ 06	10																																																																																																																								
PLLJ 1/4	10	GPLLJ 08	10																																																																																																																								
PLLJ 5/16	10	GPLLJ 10	5																																																																																																																								
PLLJ 3/8	5	GPLLJ 12	5																																																																																																																								
PLLJ 1/2	5	GPLLJ 14	5																																																																																																																								
		GPLLJ 16	5																																																																																																																								
ØD(Inch)	Bag Qty	ØD(Metric)	Bag Qty																																																																																																																								
PLJ45 5/32	10	GPLJ45 04	10																																																																																																																								
PLJ45 3/16	10	GPLJ45 06	10																																																																																																																								
PLJ45 1/4	10	GPLJ45 08	10																																																																																																																								
PLJ45 5/16	10	GPLJ45 10	5																																																																																																																								
PLJ45 3/8	10	GPLJ45 12	5																																																																																																																								
PLJ45 1/2	5																																																																																																																										
ØD(Inch)	Bag Qty	ØD(Metric)	Bag Qty																																																																																																																								
PLLJ45 5/32	10	GPLLJ45 04	10																																																																																																																								
PLLJ45 3/16	10	GPLLJ45 06	10																																																																																																																								
PLLJ45 1/4	10	GPLLJ45 08	10																																																																																																																								
PLLJ45 5/16	10	GPLLJ45 10	5																																																																																																																								
PLLJ45 3/8	5	GPLLJ45 12	5																																																																																																																								
PLLJ45 1/2	5																																																																																																																										

### Model (ØD)

### Model (ØD-ØD2)

### Model (ØD)

PYJ PLUG-IN Y	PIJ TUBE SPLICER	PIG REDUCER TUBE SPLICER	PJH PLUG-IN BARB																																																																																																																																																				
																																																																																																																																																							
<table border="1"> <thead> <tr> <th>ØD(Inch)</th> <th>Bag Qty</th> <th>ØD(Metric)</th> <th>Bag Qty</th> </tr> </thead> <tbody> <tr><td>PYJ 5/32</td><td>10</td><td>GPYJ 04</td><td>10</td></tr> <tr><td>PYJ 3/16</td><td>10</td><td>GPYJ 06</td><td>10</td></tr> <tr><td>PYJ 1/4</td><td>10</td><td>GPYJ 08</td><td>10</td></tr> <tr><td>PYJ 5/16</td><td>10</td><td>GPYJ 10</td><td>5</td></tr> <tr><td>PYJ 3/8</td><td>5</td><td>GPYJ 12</td><td>5</td></tr> <tr><td>PYJ 1/2</td><td>5</td><td></td><td></td></tr> </tbody> </table>	ØD(Inch)	Bag Qty	ØD(Metric)	Bag Qty	PYJ 5/32	10	GPYJ 04	10	PYJ 3/16	10	GPYJ 06	10	PYJ 1/4	10	GPYJ 08	10	PYJ 5/16	10	GPYJ 10	5	PYJ 3/8	5	GPYJ 12	5	PYJ 1/2	5			<table border="1"> <thead> <tr> <th>ØD(Inch)</th> <th>Bag Qty</th> <th>ØD(Metric)</th> <th>Bag Qty</th> </tr> </thead> <tbody> <tr><td>PIJ 5/32</td><td>10</td><td>PIJ 04</td><td>10</td></tr> <tr><td>PIJ 3/16</td><td>10</td><td>PIJ 06</td><td>10</td></tr> <tr><td>PIJ 1/4</td><td>10</td><td>PIJ 08</td><td>10</td></tr> <tr><td>PIJ 5/16</td><td>10</td><td>PIJ 10</td><td>10</td></tr> <tr><td>PIJ 3/8</td><td>10</td><td>PIJ 12</td><td>10</td></tr> <tr><td>PIJ 1/2</td><td>10</td><td>PIJ 14</td><td>10</td></tr> <tr><td></td><td></td><td>PIJ 16</td><td>10</td></tr> </tbody> </table>	ØD(Inch)	Bag Qty	ØD(Metric)	Bag Qty	PIJ 5/32	10	PIJ 04	10	PIJ 3/16	10	PIJ 06	10	PIJ 1/4	10	PIJ 08	10	PIJ 5/16	10	PIJ 10	10	PIJ 3/8	10	PIJ 12	10	PIJ 1/2	10	PIJ 14	10			PIJ 16	10	<table border="1"> <thead> <tr> <th>ØD - ØD2(Inch)</th> <th>Bag Qty</th> <th>ØD - ØD2(Metric)</th> <th>Bag Qty</th> </tr> </thead> <tbody> <tr><td>PIG 3/16-5/32</td><td>10</td><td>PIG 0604</td><td>10</td></tr> <tr><td>PIG 1/4-5/32</td><td>10</td><td>PIG 0804</td><td>10</td></tr> <tr><td>PIG 1/4-3/16</td><td>10</td><td>PIG 0806</td><td>10</td></tr> <tr><td>PIG 5/16-5/32</td><td>10</td><td>PIG 1006</td><td>10</td></tr> <tr><td>PIG 5/16-1/4</td><td>10</td><td>PIG 1008</td><td>10</td></tr> <tr><td>PIG 3/8-1/4</td><td>10</td><td>PIG 1208</td><td>10</td></tr> <tr><td>PIG 3/8-5/16</td><td>10</td><td>PIG 1210</td><td>10</td></tr> <tr><td>PIG 1/2-5/16</td><td>10</td><td>PIG 1612</td><td>10</td></tr> <tr><td>PIG 1/2-3/8</td><td>10</td><td></td><td></td></tr> </tbody> </table>	ØD - ØD2(Inch)	Bag Qty	ØD - ØD2(Metric)	Bag Qty	PIG 3/16-5/32	10	PIG 0604	10	PIG 1/4-5/32	10	PIG 0804	10	PIG 1/4-3/16	10	PIG 0806	10	PIG 5/16-5/32	10	PIG 1006	10	PIG 5/16-1/4	10	PIG 1008	10	PIG 3/8-1/4	10	PIG 1208	10	PIG 3/8-5/16	10	PIG 1210	10	PIG 1/2-5/16	10	PIG 1612	10	PIG 1/2-3/8	10			<table border="1"> <thead> <tr> <th>ØD (Inch) Barb</th> <th>Bag Qty</th> <th>ØD (Metric) Barb</th> <th>Bag Qty</th> </tr> </thead> <tbody> <tr><td>PJH 04-1/8</td><td>10</td><td>PJH 0404</td><td>10</td></tr> <tr><td>PJH 08-1/4</td><td>10</td><td>PJH 0405</td><td>10</td></tr> <tr><td>PJH 10-1/4</td><td>10</td><td>PJH 0605</td><td>10</td></tr> <tr><td>PJH 12-1/2</td><td>10</td><td>PJH 0606</td><td>10</td></tr> <tr><td>PJH 14-1/2</td><td>10</td><td>PJH 0806</td><td>10</td></tr> <tr><td></td><td></td><td>PJH 0808</td><td>10</td></tr> <tr><td></td><td></td><td>PJH 1008</td><td>10</td></tr> <tr><td></td><td></td><td>PJH 1208</td><td>10</td></tr> <tr><td></td><td></td><td>PJH 1210</td><td>10</td></tr> <tr><td></td><td></td><td>PJH 1213</td><td>10</td></tr> <tr><td></td><td></td><td>PJH 1414</td><td>10</td></tr> </tbody> </table>	ØD (Inch) Barb	Bag Qty	ØD (Metric) Barb	Bag Qty	PJH 04-1/8	10	PJH 0404	10	PJH 08-1/4	10	PJH 0405	10	PJH 10-1/4	10	PJH 0605	10	PJH 12-1/2	10	PJH 0606	10	PJH 14-1/2	10	PJH 0806	10			PJH 0808	10			PJH 1008	10			PJH 1208	10			PJH 1210	10			PJH 1213	10			PJH 1414	10
ØD(Inch)	Bag Qty	ØD(Metric)	Bag Qty																																																																																																																																																				
PYJ 5/32	10	GPYJ 04	10																																																																																																																																																				
PYJ 3/16	10	GPYJ 06	10																																																																																																																																																				
PYJ 1/4	10	GPYJ 08	10																																																																																																																																																				
PYJ 5/16	10	GPYJ 10	5																																																																																																																																																				
PYJ 3/8	5	GPYJ 12	5																																																																																																																																																				
PYJ 1/2	5																																																																																																																																																						
ØD(Inch)	Bag Qty	ØD(Metric)	Bag Qty																																																																																																																																																				
PIJ 5/32	10	PIJ 04	10																																																																																																																																																				
PIJ 3/16	10	PIJ 06	10																																																																																																																																																				
PIJ 1/4	10	PIJ 08	10																																																																																																																																																				
PIJ 5/16	10	PIJ 10	10																																																																																																																																																				
PIJ 3/8	10	PIJ 12	10																																																																																																																																																				
PIJ 1/2	10	PIJ 14	10																																																																																																																																																				
		PIJ 16	10																																																																																																																																																				
ØD - ØD2(Inch)	Bag Qty	ØD - ØD2(Metric)	Bag Qty																																																																																																																																																				
PIG 3/16-5/32	10	PIG 0604	10																																																																																																																																																				
PIG 1/4-5/32	10	PIG 0804	10																																																																																																																																																				
PIG 1/4-3/16	10	PIG 0806	10																																																																																																																																																				
PIG 5/16-5/32	10	PIG 1006	10																																																																																																																																																				
PIG 5/16-1/4	10	PIG 1008	10																																																																																																																																																				
PIG 3/8-1/4	10	PIG 1208	10																																																																																																																																																				
PIG 3/8-5/16	10	PIG 1210	10																																																																																																																																																				
PIG 1/2-5/16	10	PIG 1612	10																																																																																																																																																				
PIG 1/2-3/8	10																																																																																																																																																						
ØD (Inch) Barb	Bag Qty	ØD (Metric) Barb	Bag Qty																																																																																																																																																				
PJH 04-1/8	10	PJH 0404	10																																																																																																																																																				
PJH 08-1/4	10	PJH 0405	10																																																																																																																																																				
PJH 10-1/4	10	PJH 0605	10																																																																																																																																																				
PJH 12-1/2	10	PJH 0606	10																																																																																																																																																				
PJH 14-1/2	10	PJH 0806	10																																																																																																																																																				
		PJH 0808	10																																																																																																																																																				
		PJH 1008	10																																																																																																																																																				
		PJH 1208	10																																																																																																																																																				
		PJH 1210	10																																																																																																																																																				
		PJH 1213	10																																																																																																																																																				
		PJH 1414	10																																																																																																																																																				





# COMPACT ONE TOUCH FITTINGS

## Application:

- Compact one-touch fittings useful for confined spaces
- Wide variety of models available to meet all needs



## Features:

- The world's smallest quick-fitting joints feature 40% smaller volume ratio
- and 20% smaller O.D. ratio in comparison to conventional type
- Elliptical sleeve allows easy connect/disconnect by one touch
- Fittings include NBR O-ring and Teflon treated threads

### STRUCTURAL DIAGRAM

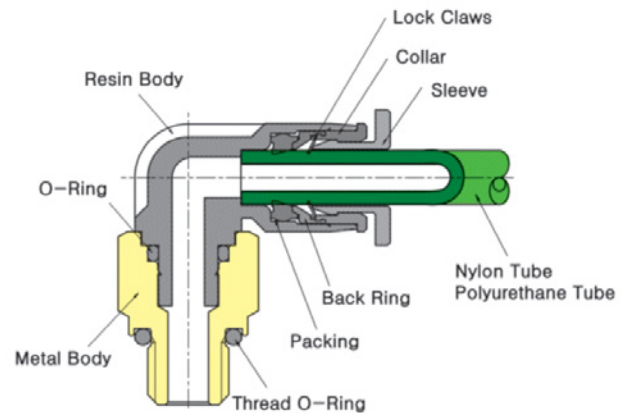



Specifications		
Fluid	AIR (No other gases or liquids)	
Working Pressure Range	0 ~ 150 psi	0 ~ 1034 kPa
Negative Pressure	-14.5 psi	-100 kPa
Temperature Range	32 ~ 140F	0 ~ 60C
Applicable Tubing	Polyurethane and Nylon	

### Model (ØD-R)

	ØD (Inch) - R (NPT) Bag Qty	ØD (Inch) - R (BSPT) Bag Qty	ØD (Metric) - R (BSPT) Bag Qty	ØD (Metric) - R (BSPP) Bag Qty
<b>PC-C</b> MALE STRAIGHT  	PC 1/8-U10C .....10	PC 1/8-M3C .....10	PC 03M3C(1.2).....10	PC 04G01C(3.0).....10
	PC 1/8-N1/16C .....10	PC 1/8-M5C .....10	PC 03M5C(2.0).....10	PC 06G01C(4.5).....10
	PC 1/8-N01C .....10	PC 1/8-M6C .....10	PC 03M6C(2.0).....10	
	PC 5/32-U10C .....10	PC 5/32-M3C .....10	PC 04M3C(1.2).....10	
	PC 5/32-N1/16C .....10	PC 5/32-M5C .....10	PC 04M5C(2.0).....10	
	PC 5/32-N01C .....10	PC 5/32-M6C .....10	PC 04M6C(3.0).....10	
	PC 1/4-U10C .....10	PC 5/32-01C .....10	PC 0401C(3.0).....10	
	PC 1/4-N1/16C .....10	PC 1/4-M5C .....10	PC 06M5C(2.0).....10	
	PC 1/4-N01C .....10	PC 1/4-M6C .....10	PC 06M6C(3.0).....10	
		PC 1/4-01C .....10	PC 0601C(4.5).....10	

### Model (ØD-R)

	ØD (Inch) - R (NPT) Bag Qty	ØD (Inch) - R (BSPT) Bag Qty	ØD (Metric) - R (BSPT) Bag Qty	ØD (Metric) - R (BSPP) Bag Qty
<b>POC-C</b> ROUND MALE STRAIGHT  	POC 1/8-U10C .....10	POC 1/8-M3C .....10	POC 03M3C(H1.5) .....10	POC 04G01C(H3.0) .....10
	POC 1/8-N1/16C .....10	POC 1/8-M5C .....10	POC 03M5C(H2.0) .....10	POC 06G01C(H4.0) .....10
	POC 1/8-N01C .....10	POC 1/8-M6C .....10	POC 03M6C(H2.0) .....10	
	POC 5/32-U10C .....10	POC 5/32-M3C .....10	POC 04M3C(H1.5) .....10	
	POC 5/32-N1/16C .....10	POC 5/32-M5C .....10	POC 04M5C(H2.5) .....10	
	POC 5/32-N01C .....10	POC 5/32-M6C .....10	POC 04M6C(H3.0) .....10	
	POC 1/4-U10C .....10	POC 5/32-01C .....10	POC 0401C(H3.0) .....10	
	POC 1/4-N1/16C .....10	POC 1/4-M5C .....10	POC 06M5C(H2.5) .....10	
	POC 1/4-N01C .....10	POC 1/4-M6C .....10	POC 06M6C(H3.0) .....10	
		POC 1/4-01C .....10	POC 0601C(H4.0) .....10	

Model (ØD-R)				
	ØD (Inch) - R (NPT) Bag Qty	ØD (Inch) - R (BSPT) Bag Qty	ØD (Metric) - R (BSPT) Bag Qty	
<b>PCF-C</b> FEMALE STRAIGHT  	PCF 1/8-U10C.....10	PCF 1/8-M3C.....10	PCF 03M3C.....10	
	PCF 1/8-N1/16C.....10	PCF 1/8-M5C.....10	PCF 03M5C.....10	
	PCF 5/32-U10C.....10	PCF 5/32-M3C.....10	PCF 04M3C.....10	
	PCF 5/32-N1/16C.....10	PCF 5/32-M5C.....10	PCF 04M5C.....10	

Model (ØD-R)				
	ØD (Inch) - R (NPT) Bag Qty	ØD (Inch) - R (BSPT) Bag Qty	ØD (Metric) - R (BSPT) Bag Qty	ØD (Metric) - R (BSPP) Bag Qty
<b>PL-C</b> MALE ELBOW  	PL 1/8-N01C.....10	PL 1/8-M3C.....10	PL 03M3C(1.2).....10	PL 04G01C(4.8).....10
	PL 1/8-N1/16C.....10	PL 1/8-M5C.....10	PL 03M5C(2.0).....10	PL 06G01C(4.8).....10
	PL 1/8-U10C.....10	PL 1/8-M6C.....10	PL 03M6C(3.0).....10	
	PL 5/32-N01C.....10	PL 5/32-01C.....10	PL 04M3C(1.2).....10	
	PL 5/32-U10C.....10	PL 5/32-M3C.....10	PL 04M5C(2.0).....10	
	PL 5/32-N1/16C.....10	PL 5/32-M5C.....10	PL 04M6C(3.0).....10	
	PL 1/4-N01C.....10	PL 5/32-M6C.....10	PL 0401C(4.8).....10	
	PL 1/4-N1/16C.....10	PL 1/4-01C.....10	PL 06M5C(2.0).....10	
	PL 1/4-U10C.....10	PL 1/4-M5C.....10	PL 06M6C(3.0).....10	
		PL 1/4-M6C.....10	PL 0601C(4.8).....10	

Model (ØD-R)				
	ØD (Inch) - R (NPT) Bag Qty	ØD (Inch) - R (BSPT) Bag Qty	ØD (Metric) - R (BSPT) Bag Qty	ØD (Metric) - R (BSPP) Bag Qty
<b>PLL-C</b> EXTENDED MALE ELBOW  	PLL 1/8-U10C.....10	PLL 1/8-M3C.....10	PLL 03M3C(1.2).....10	PLL 04G01C(4.8).....10
	PLL 1/8-N1/16C.....10	PLL 1/8-M5C.....10	PLL 03M5C(2.0).....10	PLL 06G01C(4.8).....10
	PLL 1/8-N01C.....10	PLL 5/32-M3C.....10	PLL 04M3C(1.2).....10	
	PLL 5/32-U10C.....10	PLL 5/32-M5C.....10	PLL 04M5C(2.0).....10	
	PLL 5/32-N1/16C.....10	PLL 5/32-M6C.....10	PLL 04M6C(3.0).....10	
	PLL 5/32-N01C.....10	PLL 5/32-01C.....10	PLL 0401C(4.8).....10	
	PLL 1/4-U10C.....10	PLL 1/4-M5C.....10	PLL 06M5C(2.0).....10	
	PLL 1/4-N1/16C.....10	PLL 1/4-M6C.....10	PLL 06M6C(3.0).....10	
	PLL 1/4-N01C.....10	PLL 1/4-01C.....10	PLL 0601C(4.8).....10	

Model (ØD-R)				
	ØD (Inch) - R (NPT) Bag Qty	ØD (Inch) - R (BSPT) Bag Qty	ØD (Metric) - R (BSPT) Bag Qty	ØD (Metric) - R (BSPP) Bag Qty
<b>PT-C</b> MALE BRANCH TEE  	PT 1/8-U10C.....10	PT 1/8-M3C.....10	PT 03M3C(1.2).....10	PT 04G01C(4.8).....10
	PT 1/8-N1/16C.....10	PT 1/8-M5C.....10	PT 03M5C(2.0).....10	PT 06G01C(4.8).....10
	PT 1/8-N01C.....10	PT 1/8-M6C.....10	PT 03M6C(3.0).....10	
	PT 5/32-U10C.....10	PT 5/32-M3C.....10	PT 04M3C(1.2).....10	
	PT 5/32-N1/16C.....10	PT 5/32-M5C.....10	PT 04M5C(2.0).....10	
	PT 5/32-N01C.....10	PT 5/32-M6C.....10	PT 04M6C(3.0).....10	
	PT 1/4-U10C.....10	PT 5/32-01C.....10	PT 0401C(4.8).....10	
	PT 1/4-N1/16C.....10	PT 1/4-M5C.....10	PT 06M5C(2.0).....10	
	PT 1/4-N01C.....10	PT 1/4-M6C.....10	PT 06M6C(3.0).....10	
		PT 1/4-01C.....10	PT 0601C(4.8).....10	

Model (ØD-R)				
	ØD (Inch) - R (NPT) Bag Qty	ØD (Inch) - R (BSPT) Bag Qty	ØD (Metric) - R (BSPT) Bag Qty	ØD (Metric) - R (BSPP) Bag Qty
<b>PST-C</b> MALE RUN TEE  	PST 1/8-N01C.....10	PST 1/8-M3C.....10	PST 03M3C(1.2).....10	PST 04G01C(4.8).....10
	PST 1/8-N1/16C.....10	PST 1/8-M5C.....10	PST 03M5C(2.0).....10	PST 06G01C(4.8).....10
	PST 1/8-U10C.....10	PST 1/8-M6C.....10	PST 03M6C(3.0).....10	
	PST 5/32-N01C.....10	PST 5/32-M3C.....10	PST 04M3C(1.2).....10	
	PST 5/32-N1/16C.....10	PST 5/32-M5C.....10	PST 04M5C(2.0).....10	
	PST 5/32-U10C.....10	PST 5/32-M6C.....10	PST 04M6C(3.0).....10	
	PST 1/4-N01C.....10	PST 5/32-01C.....10	PST 0401C(4.8).....10	
	PST 1/4-N1/16C.....10	PST 1/4-M5C.....10	PST 06M5C(2.0).....10	
	PST 1/4-U10C.....10	PST 1/4-M6C.....10	PST 06M6C(3.0).....10	
		PST 1/4-01C.....10	PST 0601C(4.8).....10	

Model (ØD)	Model (ØD)	Model (ØD)	Model (ØD)
<b>PUC-C</b> UNION STRAIGHT	<b>PUL-C</b> UNION ELBOW	<b>PUT-C</b> UNION TEE	<b>PY-C</b> UNION Y
			
<b>ØD (Inch)</b> Bag Qty	<b>ØD (Inch)</b> Bag Qty	<b>ØD (Inch)</b> Bag Qty	<b>ØD (Inch)</b> Bag Qty
PUC 1/8C .....10 PUC 5/32C .....10 PUC 1/4C .....10	PUL 1/8C .....10 PUL 5/32C .....10 PUL 1/4C .....10	PUT 1/8C .....10 PUT 5/32C .....10 PUT 1/4C .....10	PY 1/8C .....10 PY 5/32C .....10 PY 1/4C .....10
<b>ØD (Metric)</b> Bag Qty	<b>ØD (Metric)</b> Bag Qty	<b>ØD (Metric)</b> Bag Qty	<b>ØD (Metric)</b> Bag Qty
PUC 03C .....10 PUC 04C .....10 PUC 06C .....10	PUL 03C .....10 PUL 04C .....10 PUL 06C .....10	PUT 03C .....10 PUT 04C .....10 PUT 06C .....10	PY 03C .....10 PY 04C .....10 PY 06C .....10
<b>Model (ØD-ØD2)</b>	<b>Model (ØD)</b>	<b>Model (ØD)</b>	<b>Model (ØD-ØD2)</b>
<b>PG-C</b> REDUCER	<b>PLJ-C</b> PLUG-IN ELBOW	<b>PZA-C</b> UNION CROSS	<b>PW-C</b> REDUCER Y
			
<b>ØD(Inch) - ØD2(Inch)</b> Bag Qty	<b>ØD (Inch)</b> Bag Qty	<b>ØD (Inch)</b> Bag Qty	<b>ØD(Inch) - ØD2(Inch)</b> Bag Qty
PG 5/32-1/8C .....10	PLJ 1/8C .....10 PLJ 5/32C .....10 PLJ 1/4C .....10	PZA 1/8C .....10 PZA 5/32C .....10 PZA 1/4C .....10	PW 5/32-1/8C .....10 PW 1/4-5/32C .....10
<b>ØD(Metric) - ØD2(Metric)</b> Bag Qty	<b>ØD (Metric)</b> Bag Qty	<b>ØD (Metric)</b> Bag Qty	<b>ØD(Metric) - ØD2(Metric)</b> Bag Qty
PG 0403C .....10 PG 0604C .....10	PLJ 03C .....10 PLJ 04C .....10 PLJ 06C .....10	PZA 03C .....10 PZA 04C .....10 PZA 06C .....10	PW 0403C .....10 PW 0604C .....10
<b>Model (ØD)</b>	<b>Model (ØD)</b>	<b>Model (ØD)</b>	<b>Model (ØD-ØD2)</b>
<b>PMM-C</b> BULKHEAD UNION	<b>PLM-C</b> BULKHEAD UNION ELBOW	<b>PYJ-C</b> PLUG-IN Y	<b>PWJ-C</b> PLUG-IN REDUCER Y
			
<b>ØD (Inch)</b> Bag Qty	<b>ØD (Metric)</b> Bag Qty	<b>ØD (Inch)</b> Bag Qty	<b>ØD(Inch) - ØD2(Inch)</b> Bag Qty
PMM 1/8C .....10 PMM 5/32C .....10	PLM 03C .....10 PLM 04C .....10 PLM 06C .....10	PYJ 1/8C .....10 PYJ 5/32C .....10 PYJ 1/4C .....10	PWJ 5/32-1/8C .....10 PWJ 1/4-5/32C .....10
<b>ØD (Metric)</b> Bag Qty		<b>ØD (Metric)</b> Bag Qty	<b>ØD(Metric) - ØD2(Metric)</b> Bag Qty
PMM 03C .....10 PMM 04C .....10 PMM 06C .....10		PYJ 03C .....10 PYJ 04C .....10 PYJ 06C .....10	PWJ 0403C .....10 PWJ 0604C .....10
<b>Model (ØD-ØD2)</b>	<b>Model (ØD)</b>	<b>Model (ØD)</b>	<b>Model (ØD-R)</b>
<b>PGJ-C</b> PLUG-IN REDUCER	<b>PP-C</b> PLUG	<b>PPF-C</b> CAP	<b>PCC-C</b> ROUND MALE STRAIGHT
			
<b>ØD(Inch) - ØD2(Inch)</b> Bag Qty	<b>ØD (Inch)</b> Bag Qty	<b>ØD (Inch)</b> Bag Qty	<b>ØD (Inch) - R (BSPT)</b> Bag Qty
PGJ 1/4-5/32C .....10	PP 1/8C .....10 PP 1/4C .....10	PPF 1/8C .....10 PPF 5/32C .....10 PPF 1/4C .....10	PCC 1/8-M6C .....10
<b>ØD(Metric) - ØD2(Metric)</b> Bag Qty	<b>ØD (Metric)</b> Bag Qty	<b>ØD (Metric)</b> Bag Qty	<b>ØD (Metric) - R (Metric)</b> Bag Qty
PGJ 0403C .....10 PGJ 0604C .....10	PP 03C .....10	PPF 03C .....10 PPF 04C .....10 PPF 06C .....10	PCC 03M6C(H2.0) .....10 PCC 04M6C(H2.5) .....10 PCC 04M8C(H3.0) .....10 PCC 06M8C(H4.0) .....10

\*PCC ONLY: M6X0.75, M8X0.75

# Metallic One Touch Fittings

## APPLICATION:

- One-touch fittings used for piping Air or select Fluids
- Not suitable for potable water systems

## FEATURES:

- Easy to connect/disconnect tube by one touch
- Nickel plated brass construction
- Fittings include NBR O-ring and Teflon treated threads



Specifications		
Fluid	AIR or Select Fluids	
Working Pressure Range	0 ~ 290 psi	0 ~ 1999 kPa
Negative Pressure	-14.5 psi	-100 kPa
Temperature Range	-4 ~ 176F	-20 ~ 80C
Applicable Tubing	Polyurethane and Nylon	

\*SPECIFICATIONS APPLY FOR AIR ONLY

	Model (ØD-R)			
	ØD (Inch) - R (NPT) Bag Qty	ØD (Inch) - R (BSPP) Bag Qty	ØD (Metric) - R (BSPT) Bag Qty	ØD (Metric) - R (BSPP) Bag Qty
<b>MPC</b> MALE STRAIGHT  	MPC 5/32-N1/8.....10	MPC 5/32-G1/8.....10	MPC 04-M5.....10	MPC 04-G01.....10
	MPC 5/32-N1/4.....10	MPC 5/32-G1/4.....10	MPC 04-01.....10	MPC 04-G02.....10
	MPC 1/4-N1/8.....10	MPC 1/4-G1/8.....10	MPC 04-02.....10	MPC 06-G01.....10
	MPC 1/4-N1/4.....10	MPC 1/4-G1/4.....10	MPC 06-M5.....10	MPC 06-G02.....10
	MPC 1/4-N3/8.....10	MPC 1/4-G3/8.....10	MPC 06-01.....10	MPC 06-G03.....10
	MPC 1/4-N1/2.....10	MPC 1/4-G1/2.....10	MPC 06-02.....10	MPC 06-G04.....10
	MPC 5/16-N1/8.....10	MPC 5/16-G1/8.....10	MPC 06-03.....10	MPC 08-G01.....10
	MPC 5/16-N1/4.....10	MPC 5/16-G1/4.....10	MPC 06-04.....10	MPC 08-G02.....10
	MPC 5/16-N3/8.....10	MPC 5/16-G3/8.....10	MPC 08-01.....10	MPC 08-G03.....10
	MPC 5/16-N1/2.....10	MPC 5/16-G1/2.....10	MPC 08-02.....10	MPC 08-G04.....10
	MPC 3/8-N1/8.....10	MPC 3/8-G1/8.....10	MPC 08-03.....10	MPC 10-G01.....10
	MPC 3/8-N1/4.....10	MPC 3/8-G1/4.....10	MPC 08-04.....10	MPC 10-G02.....10
	MPC 3/8-N3/8.....10	MPC 3/8-G3/8.....10	MPC 10-01.....10	MPC 10-G03.....10
	MPC 3/8-N1/2.....10	MPC 3/8-G1/2.....10	MPC 10-02.....10	MPC 10-G04.....10
	MPC 1/2-N1/8.....10	MPC 1/2-G1/8.....10	MPC 10-03.....10	MPC 12-G01.....10
	MPC 1/2-N1/4.....10	MPC 1/2-G1/4.....10	MPC 10-04.....10	MPC 12-G02.....10
	MPC 1/2-N3/8.....10	MPC 1/2-G3/8.....10	MPC 12-01.....10	MPC 12-G03.....10
	MPC 1/2-N1/2.....5	MPC 1/2-G1/2.....5	MPC 12-02.....10	MPC 12-G04.....5
			MPC 12-03.....10	MPC 14-G03.....5
			MPC 12-04.....5	MPC 14-G04.....5
			MPC 14-03.....5	MPC 16-G03.....5
			MPC 14-04.....5	MPC 16-G04.....5
		MPC 16-03.....5		
		MPC 16-04.....5		

### Model (ØD-R)

	ØD (Inch) - R (NPT)	Bag Qty	ØD (Inch) - R (BSPP)	Bag Qty	ØD (Metric) - R (BSPT)	Bag Qty	ØD (Metric) - R (BSPP)	Bag Qty
<b>MPCF</b> FEMALE STRAIGHT  	MPCF 5/32-N1/8.....	10	MPCF 5/32-G1/8.....	10	MPCF 04-M5.....	10	MPCF 04-G01.....	10
	MPCF 5/32-N1/4.....	10	MPCF 5/32-G1/4.....	10	MPCF 04-01.....	10	MPCF 04-G02.....	10
	MPCF 1/4-N1/8.....	10	MPCF 1/4-G1/8.....	10	MPCF 04-02.....	10	MPCF 06-G01.....	10
	MPCF 1/4-N1/4.....	10	MPCF 1/4-G1/4.....	10	MPCF 06-M5.....	10	MPCF 06-G02.....	10
	MPCF 1/4-N3/8.....	10	MPCF 1/4-G3/8.....	10	MPCF 06-01.....	10	MPCF 06-G03.....	10
	MPCF 1/4-N1/2.....	10	MPCF 1/4-G1/2.....	10	MPCF 06-02.....	10	MPCF 06-G04.....	10
	MPCF 5/16-N1/8.....	10	MPCF 5/16-G1/8.....	10	MPCF 06-03.....	10	MPCF 08-G01.....	10
	MPCF 5/16-N1/4.....	10	MPCF 5/16-G1/4.....	10	MPCF 06-04.....	10	MPCF 08-G02.....	10
	MPCF 5/16-N3/8.....	10	MPCF 5/16-G3/8.....	10	MPCF 08-01.....	10	MPCF 08-G03.....	10
	MPCF 5/16-N1/2.....	10	MPCF 5/16-G1/2.....	10	MPCF 08-02.....	10	MPCF 08-G04.....	10
	MPCF 3/8-N1/8.....	10	MPCF 3/8-G1/8.....	10	MPCF 08-03.....	10	MPCF 10-G01.....	10
	MPCF 3/8-N1/4.....	10	MPCF 3/8-G1/4.....	10	MPCF 08-04.....	10	MPCF 10-G02.....	10
	MPCF 3/8-N3/8.....	10	MPCF 3/8-G3/8.....	10	MPCF 10-01.....	10	MPCF 10-G03.....	10
	MPCF 3/8-N1/2.....	10	MPCF 3/8-G1/2.....	10	MPCF 10-02.....	10	MPCF 10-G04.....	10
	MPCF 1/2-N1/8.....	10	MPCF 1/2-G1/8.....	10	MPCF 10-03.....	10	MPCF 12-G01.....	10
	MPCF 1/2-N1/4.....	10	MPCF 1/2-G1/4.....	10	MPCF 10-04.....	10	MPCF 12-G02.....	10
	MPCF 1/2-N3/8.....	10	MPCF 1/2-G3/8.....	10	MPCF 12-01.....	10	MPCF 12-G03.....	10
	MPCF 1/2-N1/2.....	5	MPCF 1/2-G1/2.....	5	MPCF 12-02.....	10	MPCF 12-G04.....	5
					MPCF 12-03.....	10	MPCF 14-G03.....	5
					MPCF 12-04.....	5	MPCF 14-G04.....	5
					MPCF 14-03.....	5	MPCF 16-G03.....	5
					MPCF 14-04.....	5	MPCF 16-G04.....	5
					MPCF 16-03.....	5		
					MPCF 16-04.....	5		

### Model (ØD-R)

	ØD (Inch) - R (NPT)	Bag Qty	ØD (Inch) - R (BSPP)	Bag Qty	ØD (Metric) - R (BSPT)	Bag Qty	ØD (Metric) - R (BSPP)	Bag Qty
<b>MPL</b> MALE ELBOW  	MPL 5/32-N1/8.....	10	MPL 5/32-G1/8.....	10	MPL 04-M5.....	10	MPL 04-G01.....	10
	MPL 5/32-N1/4.....	10	MPL 5/32-G1/4.....	10	MPL 04-01.....	10	MPL 04-G02.....	10
	MPL 1/4-N1/8.....	10	MPL 1/4-G1/8.....	10	MPL 04-02.....	10	MPL 06-G01.....	10
	MPL 1/4-N1/4.....	10	MPL 1/4-G1/4.....	10	MPL 06-M5.....	10	MPL 06-G02.....	10
	MPL 1/4-N3/8.....	10	MPL 1/4-G3/8.....	10	MPL 06-01.....	10	MPL 06-G03.....	10
	MPL 1/4-N1/2.....	10	MPL 1/4-G1/2.....	10	MPL 06-02.....	10	MPL 06-G04.....	5
	MPL 5/16-N1/8.....	10	MPL 5/16-G1/8.....	10	MPL 06-03.....	10	MPL 08-G01.....	10
	MPL 5/16-N1/4.....	10	MPL 5/16-G1/4.....	10	MPL 06-04.....	5	MPL 08-G02.....	10
	MPL 5/16-N3/8.....	10	MPL 5/16-G3/8.....	10	MPL 08-01.....	10	MPL 08-G03.....	10
	MPL 5/16-N1/2.....	5	MPL 5/16-G1/2.....	5	MPL 08-02.....	10	MPL 08-G04.....	5
	MPL 3/8-N1/8.....	10	MPL 3/8-G1/8.....	10	MPL 08-03.....	10	MPL 10-G01.....	10
	MPL 3/8-N1/4.....	5	MPL 3/8-G1/4.....	5	MPL 08-04.....	5	MPL 10-G02.....	10
	MPL 3/8-N3/8.....	5	MPL 3/8-G3/8.....	5	MPL 10-01.....	10	MPL 10-G03.....	10
	MPL 3/8-N1/2.....	5	MPL 3/8-G1/2.....	5	MPL 10-02.....	10	MPL 10-G04.....	5
	MPL 1/2-N1/8.....	5	MPL 1/2-G1/8.....	5	MPL 10-03.....	10	MPL 12-G01.....	5
	MPL 1/2-N1/4.....	5	MPL 1/2-G1/4.....	5	MPL 10-04.....	5	MPL 12-G02.....	5
	MPL 1/2-N3/8.....	5	MPL 1/2-G3/8.....	5	MPL 12-01.....	5	MPL 12-G03.....	5
	MPL 1/2-N1/2.....	5	MPL 1/2-G1/2.....	5	MPL 12-02.....	5	MPL 12-G04.....	5
					MPL 12-03.....	5	MPL 14-G03.....	5
					MPL 12-04.....	5	MPL 14-G04.....	5
					MPL 14-03.....	5	MPL 16-G03.....	5
					MPL 14-04.....	5	MPL 16-G04.....	5
					MPL 16-03.....	5		
					MPL 16-04.....	5		

### Model (ØD-R)

	ØD (Inch) - R (NPT)	Bag Qty	ØD (Inch) - R (BSPP)	Bag Qty	ØD (Metric) - R (BSPT)	Bag Qty	ØD (Metric) - R (BSPP)	Bag Qty
<b>MPH</b> MALE BANJO  	MPH 5/32-N1/8.....	10	MPH 5/32-G1/8.....	10	MPH 04-01.....	10	MPH 04-G01.....	10
	MPH 5/32-N1/4.....	10	MPH 5/32-G1/4.....	10	MPH 04-02.....	10	MPH 04-G02.....	10
	MPH 1/4-N1/8.....	10	MPH 1/4-G1/8.....	10	MPH 06-M5.....	10	MPH 06-G01.....	10
	MPH 1/4-N1/4.....	10	MPH 1/4-G1/4.....	10	MPH 06-01.....	10	MPH 06-G02.....	10
	MPH 1/4-N3/8.....	10	MPH 1/4-G3/8.....	10	MPH 06-02.....	10	MPH 06-G03.....	10
	MPH 1/4-N1/2.....	10	MPH 1/4-G1/2.....	10	MPH 06-03.....	10	MPH 06-G04.....	5
	MPH 5/16-N1/8.....	10	MPH 5/16-G1/8.....	10	MPH 06-04.....	5	MPH 08-G01.....	10
	MPH 5/16-N1/4.....	10	MPH 5/16-G1/4.....	10	MPH 08-01.....	10	MPH 08-G02.....	10
	MPH 5/16-N3/8.....	5	MPH 5/16-G3/8.....	5	MPH 08-02.....	10	MPH 08-G03.....	10
	MPH 5/16-N1/2.....	5	MPH 5/16-G1/2.....	5	MPH 08-03.....	10	MPH 08-G04.....	5
	MPH 3/8-N1/8.....	5	MPH 3/8-G1/8.....	5	MPH 08-04.....	5	MPH 10-G01.....	5
	MPH 3/8-N1/4.....	5	MPH 3/8-G1/4.....	5	MPH 10-01.....	5	MPH 10-G02.....	5
	MPH 3/8-N3/8.....	5	MPH 3/8-G3/8.....	5	MPH 10-02.....	5	MPH 10-G03.....	5
	MPH 3/8-N1/2.....	5	MPH 3/8-G1/2.....	5	MPH 10-03.....	5	MPH 10-G04.....	5
	MPH 1/2-N1/4.....	5	MPH 1/2-G1/4.....	5	MPH 10-04.....	5	MPH 12-G02.....	5
	MPH 1/2-N3/8.....	5	MPH 1/2-G3/8.....	5	MPH 12-01.....	5	MPH 12-G03.....	5
	MPH 1/2-N1/2.....	5	MPH 1/2-G1/2.....	5	MPH 12-02.....	5	MPH 12-G04.....	5
					MPH 12-03.....	5		
					MPH 12-04.....	5		









Model (ØD-R)				
	ØD (Inch) - R (NPT) Bag Qty	ØD (Inch) - R (BSPP) Bag Qty	ØD (Metric) - R (BSPT) Bag Qty	ØD (Metric) -R (BSPP) Bag Qty
<b>MNSE</b> SPEED CONTROLLER ELBOW  	MPH 5/32-N1/8.....10	MPH 5/32-G1/8.....10	MPH 04-01.....10	MPH 04-G01.....10
	MPH 5/32-N1/4.....10	MPH 5/32-G1/4.....10	MPH 04-02.....10	MPH 04-G02.....10
	MPH 1/4-N1/8.....10	MPH 1/4-G1/8.....10	MPH 06-M5.....10	MPH 06-G01.....10
	MPH 1/4-N1/4.....10	MPH 1/4-G1/4.....10	MPH 06-01.....10	MPH 06-G02.....10
	MPH 1/4-N3/8.....10	MPH 1/4-G3/8.....10	MPH 06-02.....10	MPH 06-G03.....10
	MPH 1/4-N1/2.....10	MPH 1/4-G1/2.....10	MPH 06-03.....10	MPH 06-G04.....5
	MPH 5/16-N1/8.....10	MPH 5/16-G1/8.....10	MPH 06-04.....5	MPH 08-G01.....10
	MPH 5/16-N1/4.....10	MPH 5/16-G1/4.....10	MPH 08-01.....10	MPH 08-G02.....10
	MPH 5/16-N3/8.....5	MPH 5/16-G3/8.....5	MPH 08-02.....10	MPH 08-G03.....10
	MPH 5/16-N1/2.....5	MPH 5/16-G1/2.....5	MPH 08-03.....10	MPH 08-G04.....5
	MPH 3/8-N1/8.....5	MPH 3/8-G1/8.....5	MPH 08-04.....5	MPH 10-G01.....5
	MPH 3/8-N1/4.....5	MPH 3/8-G1/4.....5	MPH 10-01.....5	MPH 10-G02.....5
	MPH 3/8-N3/8.....5	MPH 3/8-G3/8.....5	MPH 10-02.....5	MPH 10-G03.....5
	MPH 3/8-N1/2.....5	MPH 3/8-G1/2.....5	MPH 10-03.....5	MPH 10-G04.....5
	MPH 1/2-N1/4.....5	MPH 1/2-G1/4.....5	MPH 10-04.....5	MPH 12-G02.....5
	MPH 1/2-N3/8.....5	MPH 1/2-G3/8.....5	MPH 12-02.....5	MPH 12-G03.....5
	MPH 1/2-N1/2.....5	MPH 1/2-G1/2.....5	MPH 12-03.....5	MPH 12-G04.....5
			MPH 12-04.....5	

Model (ØD-R)				
	ØD (Inch) - R (NPT) Bag Qty	ØD (Inch) - R (BSPP) Bag Qty	ØD (Metric) - R (BSPT) Bag Qty	ØD (Metric) -R (BSPP) Bag Qty
<b>MPT</b> MALE BRANCH TEE  	MPT 5/32-N1/8.....10	MPT 5/32-G1/8.....10	MPT 04-M5.....10	MPT 04-G01.....10
	MPT 5/32-N1/4.....10	MPT 5/32-G1/4.....10	MPT 04-01.....10	MPT 04-G02.....10
	MPT 1/4-N1/8.....10	MPT 1/4-G1/8.....10	MPT 04-02.....10	MPT 06-G01.....10
	MPT 1/4-N1/4.....10	MPT 1/4-G1/4.....10	MPT 06-M5.....10	MPT 06-G02.....10
	MPT 1/4-N3/8.....10	MPT 1/4-G3/8.....10	MPT 06-01.....10	MPT 06-G03.....10
	MPT 1/4-N1/2.....10	MPT 1/4-G1/2.....10	MPT 06-02.....10	MPT 06-G04.....5
	MPT 5/16-N1/8.....10	MPT 5/16-G1/8.....10	MPT 06-03.....10	MPT 08-G01.....10
	MPT 5/16-N1/4.....10	MPT 5/16-G1/4.....10	MPT 06-04.....5	MPT 08-G02.....10
	MPT 5/16-N3/8.....5	MPT 5/16-G3/8.....5	MPT 08-01.....10	MPT 08-G03.....10
	MPT 5/16-N1/2.....5	MPT 5/16-G1/2.....5	MPT 08-02.....10	MPT 08-G04.....5
	MPT 3/8-N1/8.....5	MPT 3/8-G1/8.....5	MPT 08-03.....10	MPT 10-G01.....5
	MPT 3/8-N1/4.....5	MPT 3/8-G1/4.....5	MPT 08-04.....5	MPT 10-G02.....5
	MPT 3/8-N3/8.....5	MPT 3/8-G3/8.....5	MPT 10-01.....5	MPT 10-G03.....5
	MPT 3/8-N1/2.....5	MPT 3/8-G1/2.....5	MPT 10-02.....5	MPT 10-G04.....5
	MPT 1/2-N1/8.....5	MPT 1/2-G1/8.....5	MPT 10-03.....5	MPT 12-G01.....5
	MPT 1/2-N1/4.....5	MPT 1/2-G1/4.....5	MPT 10-04.....5	MPT 12-G02.....5
	MPT 1/2-N3/8.....5	MPT 1/2-G3/8.....5	MPT 12-01.....5	MPT 12-G03.....5
	MPT 1/2-N1/2.....5	MPT 1/2-G1/2.....5	MPT 12-02.....5	MPT 12-G04.....5
			MPT 12-03.....5	MPT 14-G03.....4
			MPT 12-04.....5	MPT 14-G04.....4
		MPT 14-03.....4	MPT 16-G03.....4	
		MPT 14-04.....4	MPT 16-G04.....4	
		MPT 16-03.....4		
		MPT 16-04.....4		

Model (ØD-R)				
	ØD (Inch) - R (NPT) Bag Qty	ØD (Inch) - R (BSPP) Bag Qty	ØD (Metric) - R (BSPT) Bag Qty	ØD (Metric) -R (BSPP) Bag Qty
<b>MPST</b> MALE RUN TEE  	MPST 5/32-N1/8.....10	MPST 5/32-G1/8.....10	MPST 04-M5.....10	MPST 04-G01.....10
	MPST 5/32-N1/4.....10	MPST 5/32-G1/4.....10	MPST 04-01.....10	MPST 04-G02.....10
	MPST 1/4-N1/8.....10	MPST 1/4-G1/8.....10	MPST 04-02.....10	MPST 06-G01.....10
	MPST 1/4-N1/4.....10	MPST 1/4-G1/4.....10	MPST 06-M5.....10	MPST 06-G02.....10
	MPST 1/4-N3/8.....10	MPST 1/4-G3/8.....10	MPST 06-01.....10	MPST 06-G03.....10
	MPST 1/4-N1/2.....10	MPST 1/4-G1/2.....10	MPST 06-02.....10	MPST 06-G04.....5
	MPST 5/16-N1/8.....10	MPST 5/16-G1/8.....10	MPST 06-03.....10	MPST 08-G01.....10
	MPST 5/16-N1/4.....10	MPST 5/16-G1/4.....10	MPST 06-04.....5	MPST 08-G02.....10
	MPST 5/16-N3/8.....5	MPST 5/16-G3/8.....5	MPST 08-01.....10	MPST 08-G03.....10
	MPST 5/16-N1/2.....5	MPST 5/16-G1/2.....5	MPST 08-02.....10	MPST 08-G04.....5
	MPST 3/8-N1/8.....5	MPST 3/8-G1/8.....5	MPST 08-03.....10	MPST 10-G01.....5
	MPST 3/8-N1/4.....5	MPST 3/8-G1/4.....5	MPST 08-04.....5	MPST 10-G02.....5
	MPST 3/8-N3/8.....5	MPST 3/8-G3/8.....5	MPST 10-01.....5	MPST 10-G03.....5
	MPST 3/8-N1/2.....5	MPST 3/8-G1/2.....5	MPST 10-02.....5	MPST 10-G04.....5
	MPST 1/2-N1/8.....5	MPST 1/2-G1/8.....5	MPST 10-03.....5	MPST 12-G01.....5
	MPST 1/2-N1/4.....5	MPST 1/2-G1/4.....5	MPST 10-04.....5	MPST 12-G02.....5
	MPST 1/2-N3/8.....5	MPST 1/2-G3/8.....5	MPST 12-01.....5	MPST 12-G03.....5
	MPST 1/2-N1/2.....5	MPST 1/2-G1/2.....5	MPST 12-02.....5	MPST 12-G04.....5
			MPST 12-03.....5	MPST 14-G03.....4
			MPST 12-04.....5	MPST 14-G04.....4
		MPST 14-03.....4	MPST 16-G03.....4	
		MPST 14-04.....4	MPST 16-G04.....4	
		MPST 16-03.....4		
		MPST 16-04.....4		

### Model (ØD-R)

	ØD (Inch) - R (NPT)	Bag Qty	ØD (Inch) - R (BSPP)	Bag Qty	ØD (Metric) - R (BSPT)	Bag Qty	ØD (Metric) -R (BSPP)	Bag Qty
<b>MPWT</b> MALE Y 	MPWT 5/32-N1/8.....	10	MPWT 5/32-G1/8.....	10	MPWT 04-M5.....	10	MPWT 04-G01.....	10
	MPWT 5/32-N1/4.....	10	MPWT 5/32-G1/4.....	10	MPWT 04-01.....	10	MPWT 04-G02.....	10
	MPWT 1/4-N1/8.....	10	MPWT 1/4-G1/8.....	10	MPWT 04-02.....	10	MPWT 06-G01.....	10
	MPWT 1/4-N1/4.....	10	MPWT 1/4-G1/4.....	10	MPWT 06-M5.....	10	MPWT 06-G02.....	10
	MPWT 1/4-N3/8.....	10	MPWT 1/4-G3/8.....	10	MPWT 06-01.....	10	MPWT 06-G03.....	5
	MPWT 1/4-N1/2.....	10	MPWT 1/4-G1/2.....	10	MPWT 06-02.....	10	MPWT 06-G04.....	5
	MPWT 5/16-N1/8.....	10	MPWT 5/16-G1/8.....	10	MPWT 06-03.....	5	MPWT 08-G01.....	10
	MPWT 5/16-N1/4.....	10	MPWT 5/16-G1/4.....	10	MPWT 06-04.....	5	MPWT 08-G02.....	10
	MPWT 5/16-N3/8.....	5	MPWT 5/16-G3/8.....	5	MPWT 08-01.....	10	MPWT 08-G03.....	5
	MPWT 5/16-N1/2.....	5	MPWT 5/16-G1/2.....	5	MPWT 08-02.....	10	MPWT 08-G04.....	5
	MPWT 3/8-N1/8.....	5	MPWT 3/8-G1/8.....	5	MPWT 08-03.....	5	MPWT 10-G01.....	5
	MPWT 3/8-N1/4.....	5	MPWT 3/8-G1/4.....	5	MPWT 08-04.....	5	MPWT 10-G02.....	5
	MPWT 3/8-N3/8.....	5	MPWT 3/8-G3/8.....	5	MPWT 10-01.....	5	MPWT 10-G03.....	5
	MPWT 3/8-N1/2.....	5	MPWT 3/8-G1/2.....	5	MPWT 10-02.....	5	MPWT 10-G04.....	5
	MPWT 1/2-N1/8.....	5	MPWT 1/2-G1/8.....	5	MPWT 10-03.....	5	MPWT 12-G01.....	5
	MPWT 1/2-N1/4.....	5	MPWT 1/2-G1/4.....	5	MPWT 10-04.....	5	MPWT 12-G02.....	5
	MPWT 1/2-N3/8.....	5	MPWT 1/2-G3/8.....	5	MPWT 12-01.....	5	MPWT 12-G03.....	5
	MPWT 1/2-N1/2.....	5	MPWT 1/2-G1/2.....	5	MPWT 12-02.....	5	MPWT 12-G04.....	5
					MPWT 12-03.....	5	MPWT 14-G03.....	5
					MPWT 12-04.....	5	MPWT 14-G04.....	5
					MPWT 14-03.....	5	MPWT 16-G03.....	5
					MPWT 14-04.....	5	MPWT 16-G04.....	5
					MPWT 16-03.....	5		
					MPWT 16-04.....	5		

Model (ØD)	Model (ØD)	Model (ØD)	Model (ØD)	Model (ØD)
<b>MPMM</b> BULKHEAD UNION 	<b>MPUC</b> UNION 	<b>MPUL</b> UNION ELBOW 	<b>MPUT</b> UNION TEE 	<b>MPY</b> UNION Y 
ØD (Inch)      Bag Qty	ØD (Inch)      Bag Qty	ØD (Inch)      Bag Qty	ØD (Inch)      Bag Qty	ØD (Inch)      Bag Qty
MPMM 5/32..... 10 MPMM 1/4..... 10 MPMM 5/16..... 10 MPMM 3/8..... 10 MPMM 1/2..... 5	MPUC 5/32..... 10 MPUC 1/4..... 10 MPUC 5/16..... 10 MPUC 3/8..... 10 MPUC 1/2..... 5	MPUL 5/32..... 10 MPUL 1/4..... 10 MPUL 5/16..... 10 MPUL 3/8..... 5 MPUL 1/2..... 5	MPUT 5/32..... 10 MPUT 1/4..... 10 MPUT 5/16..... 10 MPUT 3/8..... 5 MPUT 1/2..... 5	MPY 5/32..... 10 MPY 1/4..... 10 MPY 5/16..... 10 MPY 3/8..... 5 MPY 1/2..... 5
ØD (Metric)      Bag Qty	ØD (Metric)      Bag Qty	ØD (Metric)      Bag Qty	ØD (Metric)      Bag Qty	ØD (Metric)      Bag Qty
MPMM 04..... 10 MPMM 06..... 10 MPMM 08..... 10 MPMM 10..... 10 MPMM 12..... 5 MPMM 14..... 5 MPMM 16..... 5	MPUC 04..... 10 MPUC 06..... 10 MPUC 08..... 10 MPUC 10..... 10 MPUC 12..... 5 MPUC 14..... 5 MPUC 16..... 5	MPUL 04..... 10 MPUL 06..... 10 MPUL 08..... 10 MPUL 10..... 5 MPUL 12..... 5 MPUL 14..... 5 MPUL 16..... 5	MPUT 04..... 10 MPUT 06..... 10 MPUT 08..... 10 MPUT 10..... 5 MPUT 12..... 5 MPUT 14..... 5 MPUT 16..... 5	MPY 04..... 10 MPY 06..... 10 MPY 08..... 10 MPY 10..... 5 MPY 12..... 5 MPY 14..... 5 MPY 16..... 5



# WATER FITTINGS

## Application:

- One-touch fittings used for piping drinking water and other beverages
- Wide variety of models available to meet all needs

## FEATURES:

- In compliance with FDA for use with drinking water and beverages
- ANSI / NSF 61 certified
- Assembled and packaged in Clean Room



Certified to  
NSF/ANSI 61

### Maximum Usable Pressure

Size Temperature	5/32"	3/16"	1/4"	5/16"	3/8"	1/2"
	4mm	5mm	6mm	8mm	10mm	12mm
1°C (33.8°F)	230 psi				170 psi	
20°C (68°F)	230 psi				170 psi	
54°C (129.2°F)	150 psi				100 psi	



\* 5/32" interchangeable with 4mm  
5/16" interchangeable with 8mm

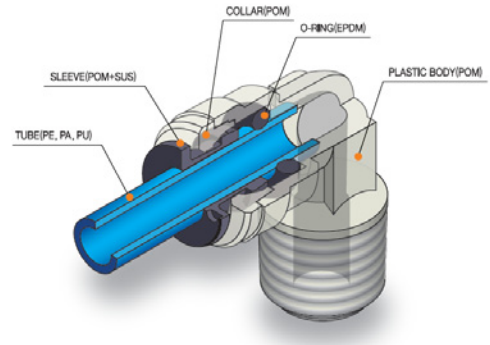

Structural Diagram













Specifications		
Fluid	Water, Beverage	
Working Pressure Range	0 ~ 230 psi	0 ~ 1586 kPa
Temperature Range	32 ~ 140F	0 ~ 60C
Applicable Tubing	Polyethylene, Polyamide, Polyurethane	

	Model (ØD-R)				
	ØD (Inch) - R (NPT)	ØD (Inch) - R (BSPT)	ØD (Inch) - R (BSPP)	ØD (Metric) - R (BSPT)	ØD (Metric) - R (BSPP)
<b>WC</b> MALE STRAIGHT 	WC 5/32-N01 WC 5/32-N02 WC 5/32-N01 WC 1/4-N01 WC 1/4-N02 WC 1/4-N03 WC 1/4-N04 WC 5/16-N01 WC 5/16-N02 WC 5/16-N03 WC 3/8-N01 WC 3/8-N02 WC 3/8-N03 WC 3/8-N04 WC 1/2-N03 WC 1/2-N04	WC 5/32-01 WC 5/32-02 WC 3/16-01 WC 3/16-02 WC 1/4-01 WC 1/4-02 WC 1/4-03 WC 1/4-04 WC 5/16-01 WC 5/16-02 WC 5/16-03 WC 3/8-01 WC 3/8-02 WC 3/8-03 WC 3/8-04 WC 1/2-03 WC 1/2-04	WC 5/32-G01 WC 5/32-G02 WC 3/16-G01 WC 3/16-G02 WC 1/4-G01 WC 1/4-G02 WC 5/16-G01 WC 5/16-G02 WC 5/16-G03 WC 3/8-G02 WC 3/8-G03 WC 3/8-G04 WC 1/2-G03 WC 1/2-G04	WC 06-01 WC 06-02 WC 06-03 WC 06-04 WC 10-01 WC 10-02 WC 10-03 WC 10-04 WC 12-03 WC 12-04	WC 06-G01 WC 06-G02 WC 10-G02 WC 10-G03 WC 10-G04 WC 12-G03 WC 12-G04

Model (ØD-R)					
	ØD (Inch) - R (NPT)	ØD (Inch) - R (BSPT)	ØD (Inch) - R (BSPP)	ØD (Metric) - R (BSPT)	ØD (Metric) - R (BSPP)
<b>WCF</b> FEMALE STRAIGHT 	WCF 1/4-N01 WCF 1/4-N02 WCF 5/16-N01 WCF 5/16-N02	WCF 5/16-01 WCF 5/16-02	WCF 1/4-G03-C WCF 1/4-G04-C WCF 5/16-G03-C WCF 5/16-G04-C WCF 3/8-G03-C WCF 3/8-G04-C WCF 1/2-G04-C	WCF 06-01 WCF 06-02 WCF 10-01 WCF 10-02	WCF 06-G03-C WCF 06-G04-C WCF 10-G03-C WCF 10-G04-C WCF 12-G04-C
Model (ØD-R)					
	ØD (Inch) - R (NPT)	ØD (Inch) - R (BSPT)	ØD (Inch) - R (BSPP)	ØD (Metric) - R (BSPT)	ØD (Metric) - R (BSPP)
<b>WCJ</b> PLUG-IN MALE 	WCJ 5/32-N01 WCJ 5/32-N02 WCJ 1/4-N01 WCJ 1/4-N02 WCJ 5/16-N01 WCJ 5/16-N02 WCJ 5/16-N03	WCJ 5/16-01 WCJ 5/16-02 WCJ 5/16-03	WCJ 5/16-G01 WCJ 5/16-G02 WCJ 5/16-G03 WCJ 3/8-G03 WCJ 3/8-G04	WCJ 06-01	WCJ 06-G01 WCJ 06-G02

Model (ØD-R)	Model (ØD)			
WL MALE ELBOW	WUL UNION ELBOW	WLJ PLUG-IN ELBOW	WZA UNION CROSS	WMM BULKHEAD UNION
				
ØD (Inch) - R (NPT)	ØD (Inch)	ØD (Inch)	ØD (Inch)	ØD (Inch)
WL 3/16-N01 WL 1/4-N01 WL 1/4-N02 WL 1/4-N03 WL 5/16-N02 WL 5/16-N03 WL 3/8-N02 WL 3/8-N03 WL 1/2-N03 WL 1/2-N04	WUL 5/32 WUL 3/16 WUL 1/4-3/16 WUL 1/4 WUL 5/16-5/32 WUL 5/16-1/4 WUL 5/16 WUL 3/8-1/4 WUL 3/8-5/16 WUL 3/8 WUL 1/2-1/4 WUL 1/2-5/16 WUL 1/2-3/8 WUL 1/2	WLJ 5/32 WLJ 3/16 WLJ 1/4 WLJ 1/4-3/8 WLJ 5/16-1/4 WLJ 5/16 WLJ 5/16-3/8 WLJ 3/8-1/4 WLJ 3/8 WLJ 1/2-3/8 WLJ 1/2	WZA 5/32 WZA 1/4 WZA 5/16 WZA 3/8 WZA 1/2	WMM 5/32 WMM 3/16 WMM 1/4 WMM 1/4-3/8 WMM 5/16 WMM 3/8-1/4 WMM 3/8 WMM 1/2
ØD (Inch) - R (BSPT)				
WL 1/4-01 WL 1/4-02 WL 5/16-02 WL 5/16-03				
ØD (Metric) - R (BSPT)	ØD (Metric)	ØD (Metric)	ØD (Metric)	ØD (Metric)
WL 06-01 WL 06-02 WL 06-03 WL 10-02 WL 10-03 WL 12-03 WL 12-04	WUL 06 WUL 10 WUL 12	WLJ 06 WLJ 10-06 WLJ 10 WLJ 12	WZA 06 WZA 10 WZA 12	WMM 06 WMM 10 WMM 12

Model (ØD)				
<b>WUC</b> UNION STRAIGHT  ØD	<b>WUT</b> UNION TEE  ØD	<b>WY</b> UNION Y  ØD	<b>WY(3)</b> 3 PORT UNION  ØD ØD2	<b>WU</b> UNION U  ØD
<b>ØD (Inch)</b>	<b>ØD (Inch)</b>	<b>ØD (Inch)</b>	<b>ØD (Inch)</b>	<b>ØD (Inch)</b>
WUC 5/32 WUC 3/16 WUC 1/4 WUC 5/16 WUC 3/8 WUC 1/2	WUT 5/32 WUT 3/16 WUT 1/4 WUT 5/16 WUT 3/8 WUT 1/2	WY 5/32 WY 1/4 WY 5/16 WY 3/8 WY 1/2	WY(3) 3/8-1/4	WU 1/4 WU 5/16
<b>ØD (Metric)</b>	<b>ØD (Metric)</b>	<b>ØD (Metric)</b>		
WUC 06 WUC 10 WUC 12	WUT 06 WUT 10 WUT 12	WY 06 WY 10 WY 12		

Model (ØD-ØD2)				
<b>WG</b> REDUCER  ØD ØD2	<b>WUG</b> REDUCER TEE  ØD ØD2	<b>WGJ</b> PLUG-IN REDUCER  ØD ØD2	<b>WJH</b> PLUG-IN BARB  ØD ØD2	<b>WJHL</b> PLUG-IN BARB ELBOW  ØD ØD2
<b>ØD(Inch) - ØD2(Inch)</b>	<b>ØD(Inch) - ØD2(Inch)</b>	<b>ØD(Inch) - ØD2(Inch)</b>	<b>ØD(Inch) - ØD2(Inch)</b>	<b>ØD(Inch) - ØD2(Inch)</b>
WG 1/4-5/32 WG 5/16-5/32 WG 5/16-1/4 WG 3/8-5/32 WG 3/8-1/4 WG 3/8-5/16 WG 1/2-5/16 WG 1/2-3/8	WUG 1/4-5/16 WUG 1/4-3/8 WUG 5/16-1/4 WUG 5/16-3/8 WUG 3/8-1/4 WUG 3/8-5/16 WUG 1/2-3/8	WGJ 3/16-5/32 WGJ 1/4-5/32 WGJ 5/16-5/32 WGJ 5/16-1/4 WGJ 5/16-3/8 WGJ 3/8-1/4 WGJ 3/8-5/16 WGJ 1/2-5/16 WGJ 1/2-3/8	WJH 1/4-1/4 WJH 5/16-3/8 WJH 3/8-5/16 WJH 3/8-3/8 WJH 3/8-1/2 WJH 1/2-3/8	WJHL 1/4-1/4 WJHL 1/4-5/16
		<b>ØD(Metric) - ØD2(Inch)</b>		
		WGJ 06-5/32 WGJ 06-3/16		

Model (ØD)	
<b>WP</b> PLUG  ØD	
<b>ØD (Inch)</b>	<b>ØD (Metric)</b>
WP 5/32 WP 3/16 WP 1/4 WP 5/16 WP 3/8 WP 1/2	WP 06 WP 10 WP 12

Model (ØD)	
<b>WPF</b> CAP  ØD	
<b>ØD (Inch)</b>	<b>ØD (Metric)</b>
WPF 5/32 WPF 3/16 WPF 1/4 WPF 5/16 WPF 3/8 WPF 1/2	WPF 06 WPF 10 WPF 12

# SPEED CONTROLLERS

## APPLICATION:

- Used to control the operating speed of driving device

## FEATURES:

- Precision control for optimal flowrates
- Compact and light body permits use in confined spaces
- Composite body swivels on metal base
- Fittings include NBR O--ring and Teflon treated threads



Specifications		
Fluid	AIR (No other gases or liquids)	
Working Pressure Range	0 ~ 150 psi	0 ~ 1034 kPa
Negative Pressure	-14.5 psi	-100 kPa
Temperature Range	32 ~ 140F	0 ~ 60C
Applicable Tubing	Polyurethane and Nylon	

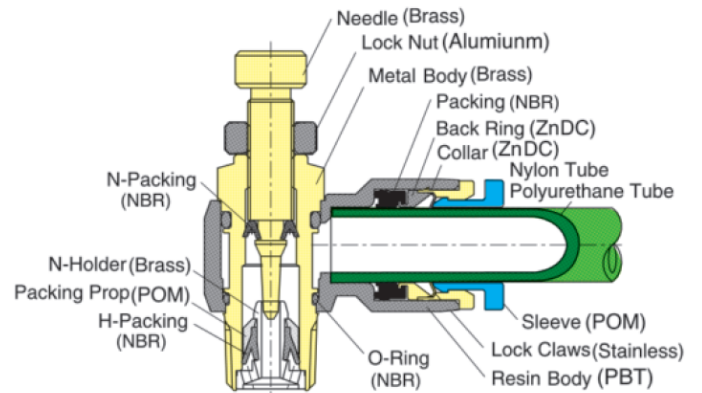

**Structural Diagram**

**METER OUT TYPE**

- Control air flow entering from Thread to Sleeve
- Air passes freely from Sleeve to Thread

**METER IN TYPE**

- Control air flow entering from Sleeve to Thread
- Air passes freely from Thread to Sleeve



**UNION TYPE**

- Pipe in accordance with signal on the body

Model (ØD-R)								
	ØD (Inch) - R (NPT)	Bag Qty	ØD (Inch) - R (BSPT)	Bag Qty	ØD (Metric) - R (BSPT)	Bag Qty	ØD (Metric) -R (BSPP)	Bag Qty
<b>NSE</b> ELBOW  	NSE 5/32-N01U EPNI	10	NSE 1/4-M5 EPNI	10	GNSE 0401 EPNI	10	GNSE 04G01 EPNI	10
	NSE 5/32-U10U EPNI	10	NSE 1/4-R01 EPNI	10	GNSE 0402 EPNI	10	GNSE 04G02 EPNI	10
	NSE 3/16-N01U EPNI	10	NSE 1/4-R02 EPNI	10	GNSE 04M5 EPNI	10	GNSE 06G01 EPNI	10
	NSE 3/16-N02U EPNI	10	NSE 1/4-R03 EPNI	5	GNSE 0601 EPNI	10	GNSE 06G02 EPNI	10
	NSE 3/16-N03U EPNI	5	NSE 5/16-R01 EPNI	10	GNSE 0602 EPNI	10	GNSE 06G03 EPNI	5
	NSE 3/16-U10U EPNI	10	NSE 5/16-R02 EPNI	10	GNSE 0603 EPNI	5	GNSE 08G01 EPNI	10
	NSE 1/4-N01U EPNI	10	NSE 5/16-R03 EPNI	5	GNSE 06M5 EPNI	10	GNSE 08G02 EPNI	10
	NSE 1/4-N02U EPNI	10	NSE 3/8-R02 EPNI	5	GNSE 0801 EPNI	10	GNSE 08G03 EPNI	5
	NSE 1/4-N03U EPNI	5	NSE 3/8-R03 EPNI	5	GNSE 0802 EPNI	10	GNSE 08G04 EPNI	5
	NSE 1/4-U10U EPNI	10	NSE 3/8-R04 EPNI	5	GNSE 0803 EPNI	5	GNSE 10G02 EPNI	5
	NSE 5/16-N01U EPNI	10			GNSE 0804 EPNI	5	GNSE 10G03 EPNI	5
	NSE 5/16-N02U EPNI	10			GNSE 1002 EPNI	5	GNSE 10G04 EPNI	5
	NSE 5/16-N03U EPNI	10			GNSE 1003 EPNI	5	GNSE 10G04 EPNI	5
	NSE 5/16-N04U EPNI	5			GNSE 1004 EPNI	5	GNSE 12G03 EPNI	5
	NSE 3/8-N02U EPNI	5			GNSE 1202 EPNI	5	GNSE 12G04 EPNI	5
	NSE 3/8-N03U EPNI	5			GNSE 1203 EPNI	5		
	NSE 3/8-N04U EPNI	5			GNSE 1204 EPNI	5		
	NSE 1/2-N03U EPNI	5						
	NSE 1/2-N04U EPNI	5						

Model (ØD-R)						
	ØD (Inch) - R (NPT)	Bag Qty	ØD (Inch) - R (BSPT)	Bag Qty	ØD (Metric) - R (BSPT)	Bag Qty
<b>NSE-C</b> ELBOW COMPACT  	NSE 1/8-U10UC EPNI	10	NSE 1/8-M3C EPNI	10	NSE 03M3C EPNI	10
	NSE 5/32-U10UC EPNI	10	NSE 1/8-M5C EPNI	10	NSE 03M5C EPNI	10
	NSE 5/32-N01C EPNI	10	NSE 5/32-M3C EPNI	10	NSE 04M3C EPNI	10
	NSE 1/4-U10UC EPNI	10	NSE 5/32-M5C EPNI	10	NSE 04M5C EPNI	10
	NSE 1/4-N01C EPNI	10	NSE 5/32-01C EPNI	10	NSE 0401C EPNI	10
			NSE 1/4-M5C EPNI	10	NSE 06M5C EPNI	10
			NSE 1/4-01C EPNI	10	NSE 0601C EPNI	10
					NSE 0602C EPNI	10

Model (ØD-R)						
	ØD (Inch) - R (NPT)	Bag Qty	ØD (Inch) - R (BSPT)	Bag Qty	ØD (Metric) - R (BSPT)	Bag Qty
<b>NSS</b> STRAIGHT  	NSS 5/32-N01U EPNI	10	NSS 5/32-M5 EPNI	10	NSS 04M5 EPNI	10
	NSS 5/32-U10U EPNI	10	NSS 5/32-01 EPNI	10	NSS 0401 EPNI	10
	NSS 3/16-N01U EPNI	10	NSS 5/32-02 EPNI	10	NSS 0402 EPNI	10
	NSS 3/16-N02U EPNI	10	NSS 3/16-M5 EPNI	10	NSS 06M5 EPNI	10
	NSS 3/16-N03U EPNI	5	NSS 3/16-01 EPNI	10	NSS 0601 EPNI	10
	NSS 3/16-U10U EPNI	10	NSS 3/16-02 EPNI	10	NSS 0602 EPNI	10
	NSS 1/4-N01U EPNI	10	NSS 3/16-03 EPNI	5	NSS 0603 EPNI	5
	NSS 1/4-N02U EPNI	10	NSS 1/4-M5 EPNI	10	NSS 0801 EPNI	10
	NSS 1/4-N03U EPNI	5	NSS 1/4-01 EPNI	10	NSS 0802 EPNI	10
	NSS 1/4-U10U EPNI	10	NSS 1/4-02 EPNI	10	NSS 0803 EPNI	5
	NSS 5/16-N01U EPNI	10	NSS 1/4-03 EPNI	5	NSS 0804 EPNI	5
	NSS 5/16-N02U EPNI	10	NSS 5/16-01 EPNI	5	NSS 1002 EPNI	5
	NSS 5/16-N03U EPNI	5	NSS 5/16-02 EPNI	10	NSS 1003 EPNI	5
	NSS 5/16-N04U EPNI	5	NSS 5/16-03 EPNI	5	NSS 1004 EPNI	5
	NSS 3/8-N02U EPNI	5	NSS 5/16-04 EPNI	5	NSS 1202 EPNI	5
	NSS 3/8-N03U EPNI	5	NSS 3/8-02 EPNI	5	NSS 1203 EPNI	5
	NSS 3/8-N04U EPNI	5	NSS 3/8-03 EPNI	5	NSS 1204 EPNI	5
	NSS 1/2-N03U EPNI	5	NSS 3/8-04 EPNI	5		
	NSS 1/2-N04U EPNI	5	NSS 1/2-02 EPNI	5		
			NSS 1/2-03 EPNI	5		
			NSS 1/2-04 EPNI	5		

Model (ØD)							
	ØD (Inch)	Bag Qty	ØD (Metric)	Bag Qty	ØD (Metric)	Bag Qty	
<b>NSF</b> UNION  	NSF 5/32 EPNI	10	GNSF 04 EPNI	10	<b>NSF-C</b> UNION COMPACT  	NSF 03C EPNI	10
	NSF 3/16 EPNI	10	GNSF 06 EPNI	5			
	NSF 1/4 EPNI	5	GNSF 08 EPNI	5			
	NSF 5/16 EPNI	5	GNSF 10 EPNI	5			
	NSF 3/8 EPNI	5	GNSF 12 EPNI	4			
	NSF 1/2 EPNI	4					

# ROTARY JOINTS

## APPLICATION:

- Used for supplying air at swiveling or swinging connections

## FEATURES:

- Built in bearings suitable for high--speed swiveling connections
- Fittings include NBR O--ring and Teflon treated threads

Specifications		
Fluid	AIR (No other gases or liquids)	
Working Pressure Range	0 ~ 150 psi	0 ~ 1034 kPa
Negative Pressure	-14.5 psi	-100 kPa
Temperature Range	32 ~ 140F	0 ~ 60C
Applicable Tubing	Polyurethane and Nylon	

Maximum Operating RPM								
Tube Dia	Metric		Ø4 mm	Ø6 mm	Ø8 mm	Ø10 mm	Ø12 mm	
	Inch		Ø5/32"	Ø3/16"	Ø1/4"	Ø5/16"	Ø3/8"	Ø1/2"
RPM	Low – NRC, NRL		500	500	500	400	300	250
	High – NHRC, NHRL, NHRS, NHRF		1500	1500	1200	1200	1000	1000



### WARNING

- Use PU tubing for high speed rotary joints
- Nylon or other hard tube may overload bearings

Structural Diagram  
High Speed Rotary Joint

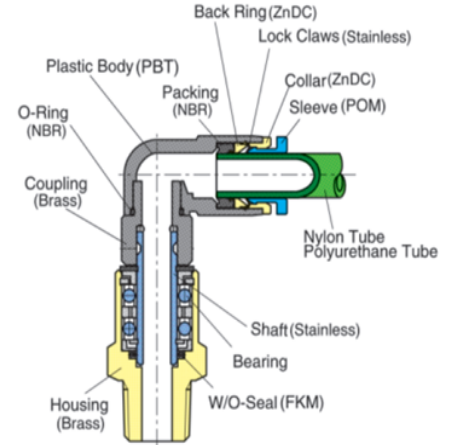

Rotary Joint

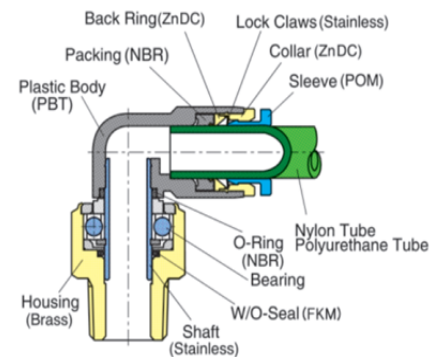



## Model (ØD-R)

	ØD (Inch) - R (NPT)	ØD (Inch) - R (BSPT)	ØD (Metric) - R (BSPT)	ØD (Metric) -R (BSPP)
<b>NRC</b> STRAIGHT 	NRC 5/32-U10U	NRC 5/32-M5	NRC 04M5	NRC 04G01
	NRC 5/32-N01U	NRC 5/32-R01	NRC 04M6	NRC 06G01
	NRC 3/16-U10U	NRC 3/16-M5	NRC 0401	NRC 06G02
	NRC 3/16-N01U	NRC 3/16-R01	NRC 06M5	NRC 08G01
	NRC 1/4-U10U	NRC 1/4-M5	NRC 06M6	NRC 08G02
	NRC 1/4-N01U	NRC 1/4-R01	NRC 0601	NRC 08G03
	NRC 1/4-N02U	NRC 1/4-R02	NRC 0602	NRC 10G03
	NRC 5/16-N01U	NRC 5/16-R01	NRC 0801	NRC 10G04
	NRC 5/16-N02U	NRC 5/16-R02	NRC 0802	NRC 12G03
	NRC 5/16-N03U	NRC 5/16-R03	NRC 0803	NRC 12G04
	NRC 3/8-N03U	NRC 3/8-R03	NRC 1003	
	NRC 3/8-N04U	NRC 3/8-R04	NRC 1004	
	NRC 1/2-N03U		NRC 1203	
	NRC 1/2-N04U		NRC 1204	

## Model (ØD-R)

	ØD (Inch) - R (NPT)	ØD (Inch) - R (BSPT)	ØD (Metric) - R (BSPT)	ØD (Metric) -R (BSPP)
<b>NRL</b> ELBOW 	NRL 5/32-U10U	NRL 5/32-M5	NRL 04M5	NRL 04G01
	NRL 5/32-N01U	NRL 5/32-R01	NRL 04M6	NRL 06G01
	NRL 3/16-U10U	NRL 3/16-M5	NRL 0401	NRL 06G02
	NRL 3/16-N01U	NRL 3/16-R01	NRL 06M5	NRL 08G01
	NRL 1/4-U10U	NRL 1/4-R01	NRL 06M6	NRL 08G02
	NRL 1/4-N01U	NRL 1/4-R02	NRL 0601	NRL 08G03
	NRL 1/4-N02U	NRL 5/16-R01	NRL 0602	NRL 10G03
	NRL 5/16-N01U	NRL 5/16-R02	NRL 0801	NRL 10G04
	NRL 5/16-N02U	NRL 5/16-R03	NRL 0802	NRL 12G03
	NRL 5/16-N03U	NRL 3/8-R03	NRL 0803	NRL 12G04
	NRL 3/8-N03U	NRL 3/8-R04	NRL 1003	
	NRL 3/8-N04U	NRL 1/2-R03	NRL 1004	
	NRL 1/2-N03U	NRL 1/2-R04	NRL 1203	
	NRL 1/2-N04U		NRL 1204	

Model (ØD-R)				
	ØD (Inch) - R (NPT)	ØD (Inch) - R (BSPT)	ØD (Metric) - R (BSPT)	ØD (Metric) -R (BSPP)
<b>NHRC</b> HIGH SPEED STRAIGHT 	NHRC 5/32-U10U NHRC 5/32-N01U NHRC 3/16-U10U NHRC 3/16-N01U NHRC 3/16-N02U NHRC 1/4-N01U NHRC 1/4-N02U NHRC 5/16-N01U NHRC 5/16-N02U NHRC 3/8-N03U NHRC 3/8-N04U NHRC 1/2-N03U NHRC 1/2-N04U	NHRC 5/32-M5 NHRC 5/32-R01 NHRC 3/16-R01 NHRC 1/4-R01 NHRC 1/4-R02 NHRC 5/16-R01 NHRC 5/16-R02 NHRC 3/8-R03 NHRC 3/8-R04 NHRC 1/2-R03 NHRC 1/2-R04	NHRC 04M5 NHRC 04M6 NHRC 0401 NHRC 0601 NHRC 0602 NHRC 0801 NHRC 0802 NHRC 1003 NHRC 1004 NHRC 1203 NHRC 1204	NHRC 04G01 NHRC 06G01 NHRC 06G02 NHRC 08G01 NHRC 08G02 NHRC 10G03 NHRC 10G04 NHRC 12G03 NHRC 12G04

Model (ØD-R)				
	ØD (Inch) - R (NPT)	ØD (Inch) - R (BSPT)	ØD (Metric) - R (BSPT)	ØD (Metric) -R (BSPP)
<b>NHRL</b> HIGH SPEED ELBOW 	NHRL 5/32-U10U NHRL 5/32-N01U NHRL 3/16-U10U NHRL 3/16-N01U NHRL 3/16-N02U NHRL 1/4-N01U NHRL 1/4-N02U NHRL 5/16-N01U NHRL 5/16-N02U NHRL 3/8-N03U NHRL 3/8-N04U NHRL 1/2-N03U NHRL 1/2-N04U	NHRL 1/4-R01 NHRL 1/4-R02 NHRL 5/16-R01 NHRL 5/16-R02 NHRL 3/8-R03 NHRL 3/8-R04 NHRL 1/2-R03 NHRL 1/2-R04	NHRL 04M5 NHRL 04M6 NHRL 0401 NHRL 0601 NHRL 0602 NHRL 0801 NHRL 0802 NHRL 1003 NHRL 1004 NHRL 1203 NHRL 1204	NHRL 04G01 NHRL 06G01 NHRL 06G02 NHRL 08G01 NHRL 08G02 NHRL 10G03 NHRL 10G04 NHRL 12G03 NHRL 12G04

Model (R-Rc)				
	R (NPT) - Rc (NPT)	R (BSPT) - Rc (BSPT)	R (BSPT) - Rc (BSPP)	R (BSPP) -Rc (BSPP)
<b>NHRF</b> HIGH SPEED BUSH 	NHRF N01-N01 NHRF N01-N02 NHRF N02-N01 NHRF N02-N02 NHRF N03-N03 NHRF N03-N04 NHRF N04-N03 NHRF N04-N04	NHRF 01-01 NHRF 01-02 NHRF 02-01 NHRF 02-02 NHRF 03-03 NHRF 03-04 NHRF 04-03 NHRF 04-04	NHRF 01-G01 NHRF 01-G02 NHRF 02-G01 NHRF 02-G02 NHRF 03-G03 NHRF 03-G04 NHRF 04-G03 NHRF 04-G04	NHRF G01-G01 NHRF G01-G02 NHRF G02-G01 NHRF G02-G02 NHRF G03-G03 NHRF G03-G04 NHRF G04-G03 NHRF G04-G04

Model (R1-R2)				
	R1 (NPT) - R2 (NPT)		R1 (BSPT) - R2 (BSPT)	R1 (BSPP) - R2 (BSPP)
<b>NHRS</b> HIGH SPEED NIPPLE 	NHRS N01-N01 NHRS N01-N02 NHRS N02-N01 NHRS N02-N02 NHRS N03-N03 NHRS N03-N04 NHRS N04-N03 NHRS N04-N04		NHRS 01-01 NHRS 01-02 NHRS 02-01 NHRS 02-02 NHRS 03-03 NHRS 03-04 NHRS 04-03 NHRS 04-04	NHRS G01-G01 NHRS G01-G02 NHRS G02-G01 NHRS G02-G02 NHRS G03-G03 NHRS G03-G04 NHRS G04-G03 NHRS G04-G04



# STOP FITTINGS

## Structural Diagram

### APPLICATION:

- Installed where pneumatic connections are changed frequently

### FEATURES:

- Air flow is stopped upon disconnection of tube
- Fittings include NBR O-ring and Teflon treated threads

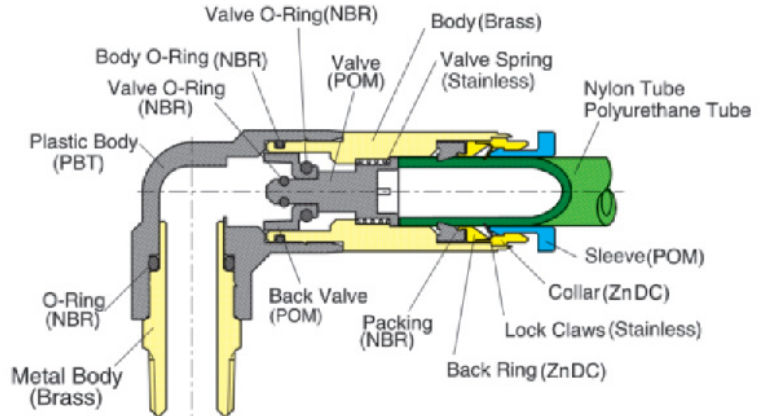



Specifications		
Fluid	AIR (No other gases or liquids)	
Working Pressure Range	0 ~ 150 psi	0 ~ 1034 kPa
Negative Pressure	-14.5 psi	-100 kPa
Temperature Range	32 ~ 140F	0 ~ 60C
Applicable Tubing	Polyurethane and Nylon	

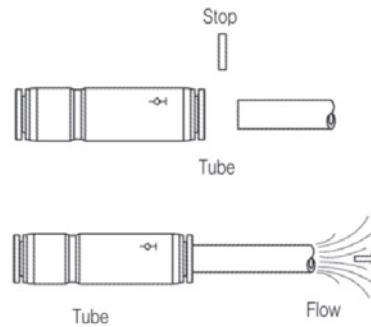

### Control Method



**WARNING**

- Beware of tube whip up after disconnection

Model (ØD-R)			
	ØD (Inch) - R (NPT)	ØD (Metric) - R (BSPT)	ØD (Metric) - R (BSPP)
<b>SPC</b> STRAIGHT  	SPC 5/32-U10U	SPC 04M5	SPC 04G01
	SPC 5/32-N01U	SPC 0401	SPC 06G01
	SPC 3/16-N01U	SPC 0601	SPC 06G02
	SPC 3/16-N02U	SPC 0602	SPC 08G02
	SPC 1/4-N01U	SPC 0802	SPC 08G03
	SPC 1/4-N02U	SPC 0803	SPC 10G02
	SPC 5/16-N02U	SPC 1002	SPC 10G03
	SPC 5/16-N03U	SPC 1003	SPC 10G04
	SPC 3/8-N03U	SPC 1004	SPC 12G03
	SPC 3/8-N04U	SPC 1203	SPC 12G04
	SPC 1/2-N03U	SPC 1204	
	SPC 1/2-N04U		
	Model (ØD-R)		
	ØD (Inch) - R (NPT)	ØD (Metric) - R (BSPT)	ØD (Metric) - R (BSPP)
<b>SPL</b> ELBOW  	SPL 5/32-U10U	SPL 04M5	SPL 04G01
	SPL 5/32-N01U	SPL 04M6	SPL 06G01
	SPL 3/16-U10U	SPL 0401	SPL 06G02
	SPL 3/16-N01U	SPL 06M5	SPL 08G01
	SPL 3/16-N02U	SPL 0601	SPL 08G02
	SPL 1/4-U10U	SPL 0602	SPL 08G03
	SPL 1/4-N01U	SPL 0801	SPL 10G02
	SPL 1/4-N02U	SPL 0802	SPL 10G03
	SPL 5/16-N01U	SPL 0803	SPL 10G04
	SPL 5/16-N02U	SPL 1002	SPL 12G03
	SPL 5/16-N03U	SPL 1003	SPL 12G04
	SPL 3/8-N02U	SPL 1004	
	SPL 3/8-N03U	SPL 1203	
SPL 3/8-N04U	SPL 1204		
SPL 1/2-N03U			
SPL 1/2-N04U			

Model (ØD)		
	ØD (Inch)	ØD (Metric)
<b>SPU</b> UNION  	SPU 5/32	SPU 04
	SPU 3/16	SPU 06
	SPU 1/4	SPU 08
	SPU 5/16	SPU 10
	SPU 3/8	SPU 12
	SPU 1/2	
Model (ØD)		
	ØD (Inch)	ØD (Metric)
<b>SPUM</b> BULKHEAD UNION  	SPUM N5/32	SPUM 04
	SPUM N3/16	SPUM 06
	SPUM N1/4	SPUM 08
	SPUM N5/16	SPUM 10
	SPUM N3/8	SPUM 12
	SPUM N1/2	



# BALL VALVES

## APPLICATION:

- Used for controlling air supply in fully open or fully closed positions



## FEATURES:

- Versatile PPS resin body allows for use in Air or Water
- Optimized cross sectional design of body maintains flow proportional to tube capacity

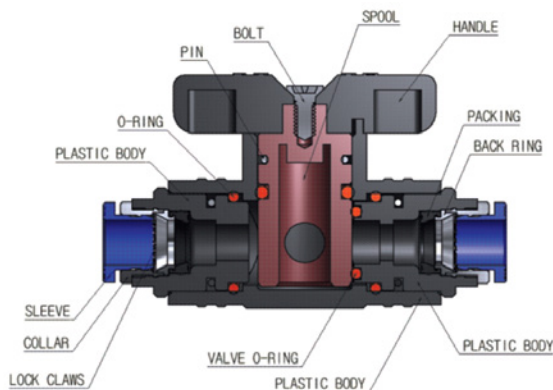
Structural Diagram





Specifications		
Fluid	Air & Water	
Working Pressure Range	0 ~ 284 psi	0 ~ 1958 kPa
Negative Pressure	-14.5 psi	-100 kPa
Temperature Range	32 ~ 176F	0 ~ 80C
Applicable Tubing	Polyurethane and Nylon	

Model (ØD-R)							
	ØD (Inch) - R (NPT)	ØD (Metric) - R (BSPT)	ØD (Metric) - R (BSPP)		ØD (Inch) - R (NPT)	ØD (Metric) - R (BSPT)	ØD (Metric) - R (BSPP)
<b>BC</b> STRAIGHT  	BC 1/4-N1/8	GBC 06-01	GBC 06-G01	<b>BL</b> ELBOW  	BL 5/16-N1/8	GBL 06-01	GBL 06-G01
	BC 1/4-N1/4	GBC 06-02	GBC 06-G02		BL 5/16-N1/4	GBL 06-02	GBL 06-G02
	BC 1/4-N3/8	GBC 06-03	GBC 06-G03		BL 5/16-N3/8	GBL 06-03	GBL 06-G03
	BC 5/16-N1/8	GBC 08-01	GBC 08-G01		BL 1/4-N1/8	GBL 08-01	GBL 08-G01
	BC 5/16-N1/4	GBC 08-02	GBC 08-G02		BL 1/4-N1/4	GBL 08-02	GBL 08-G02
	BC 5/16-N3/8	GBC 08-03	GBC 08-G03		BL 1/4-N3/8	GBL 08-03	GBL 08-G03
	BC 3/8-N1/4	GBC 10-02	GBC 10-G02		BL 3/8-N1/4	GBL 10-02	GBL 10-G02
	BC 3/8-N3/8	GBC 10-03	GBC 10-G03		BL 3/8-N3/8	GBL 10-03	GBL 10-G03
	BC 3/8-N1/2	GBC 10-04	GBC 10-G04		BL 1/2-N1/4	GBL 10-04	GBL 10-G04
	BC 1/2-N1/4	GBC 12-02	GBC 12-G02		BL 1/2-N1/4	GBL 12-02	GBL 12-G02
BC 1/2-N3/8	GBC 12-03	GBC 12-G03	BL 1/2-N3/8	GBL 12-03	GBL 12-G03		
BC 1/2-N1/2	GBC 12-04	GBC 12-G04	BL 1/2-N1/2	GBL 12-04	GBL 12-G04		
	*BC 1/4-R02		*BC 1/2-G03				

Model (ØD)	
<b>BUC</b> UNION  	
ØD (Inch)	ØD (Metric)
BUC 1/4-1/4	GBUC 0606
BUC 5/16-5/16	GBUC 0808
BUC 3/8-3/8	GBUC 1010
BUC 1/2-1/2	GBUC 1212

Model (ØD)	
<b>BUL</b> UNION ELBOW  	
ØD (Inch)	ØD (Metric)
BUL 1/4-1/4	GBUL 0606
BUL 5/16-5/16	GBUL 1010
BUL 3/8-3/8	GBUL 1212
BUL 1/2-1/2	

Model (ØD-ØD2)	
<b>BUG</b> REDUCER  	
ØD(Inch) - ØD2(Inch)	ØD(Metric) - ØD2(Metric)
BUG 5/16-1/4	GBUG 0806
BUG 1/2-3/8	GBUG 1210

Model (ØD-ØD2)	
<b>BLG</b> REDUCER UNION ELBOW  	
ØD(Inch) - ØD2(Inch)	ØD(Metric) - ØD2(Metric)
BLG 1/4-5/16	GBLG 0608
BLG 5/16-1/4	GBLG 0806
BLG 3/8-1/2	GBLG 1012
BLG 1/2-3/8	GBLG 1210

Model (ØD)	
<b>BM</b> BULKHEAD UNION  	
ØD (Inch)	ØD (Metric)
BM 1/4-1/4	GBM 0606
BM 5/16-1/4	GBM 0806
BM 5/16-5/16	GBM 0808
BM 3/8-3/8	GBM 1010
BM 1/2-3/8	GBM 1210
BM 1/2-1/2	GBM 1212

Model (ØD)	
<b>BLM</b> BULKHEAD UNION ELBOW  	
ØD (Inch)	ØD (Metric)
BLM 1/4-1/4	GBLM 0606
BLM 5/16-1/4	GBLM 0806
BLM 5/16-5/16	GBLM 0808
BLM 3/8-3/8	GBLM 1010
BLM 1/2-3/8	GBLM 1210
BLM 1/2-1/2	GBLM 1212

# CHECK VALVES

## APPLICATION:

- Used for supplying air where one-way flow is desired

## FEATURES:

- Check Valve permits airflow in only one direction and closes in reverse direction
- Check Valve keeps 1.42 PSI in vacuum, and opens at low pressures.



## Control Method

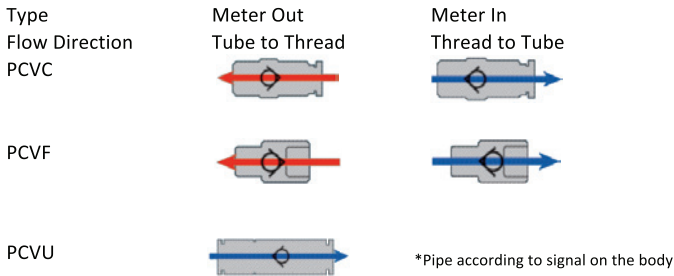

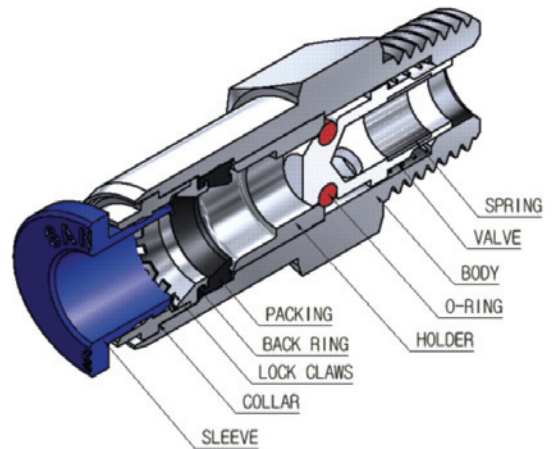

## STRUCTURAL DIAGRAM



Specifications		
Fluid	AIR (No other gases or liquids)	
Working Pressure Range	0 ~ 284 psi	0 ~ 1958 kPa
Negative Pressure	-14.5 psi	-100 kPa
Temperature Range	32 ~ 176F	0 ~ 80C
Applicable Tubing	Polyurethane and Nylon	

Model (ØD-R)	
<b>PCVC</b> STRAIGHT 	<b>ØD (Metric) - R (BSPT)</b> PCVC 04M5 PCVC 04M6 PCVC 0401 PCVC 0601 PCVC 0602 PCVC 0801 PCVC 0802 PCVC 1003 PCVC 1004 PCVC 1203 PCVC 1204
	<b>ØD (Inch) - R (NPT)</b> <b>ØD (Metric) - R (BSPP)</b> PCVC 5/32-U10U    PCVC 04G01 PCVC 5/32-N01U    PCVC 06G01 PCVC 3/16-U10U    PCVC 06G02 PCVC 3/16-N01U    PCVC 08G01 PCVC 3/16-N02U    PCVC 08G02 PCVC 1/4-N01U    PCVC 10G03 PCVC 1/4-N02U    PCVC 10G04 PCVC 5/16-N01U    PCVC 12G03 PCVC 5/16-N02U    PCVC 12G04 PCVC 3/8-N03U PCVC 3/8-N04U PCVC 1/2-N03U PCVC 1/2-N04U

Model (R-Rc)	
<b>PCVF</b> BUSH 	<b>R (BSPT) - Rc (BSPT)</b> PCVF 0101 PCVF 0202 PCVF 0303 PCVF 0404
	<b>R (NPT) - Rc (NPT)</b> <b>R (BSPP) - Rc (BSPP)</b> PCVF N01-N01    PCVF G01-G01 PCVF N02-N02    PCVF G02-G02 PCVF N03-N03    PCVF G03-G03 PCVF N04-N04    PCVF G04-G04

Model (R-Rc)	
<b>PCVU</b> UNION 	
	<b>ØD (Inch)</b> <b>ØD (Metric)</b> PCVU 5/32    PCVU 04 PCVU 3/16    PCVU 06 PCVU 1/4    PCVU 08 PCVU 5/16    PCVU 10 PCVU 3/8    PCVU 12 PCVU 1/2

# HAND VALVES

## APPLICATION:

- Used for controlling air supply in fully open or fully closed positions

## FEATURES:

- When off, three-way directional control discharges residual outlet pressure while blocking inlet pressure

## Structural Diagram

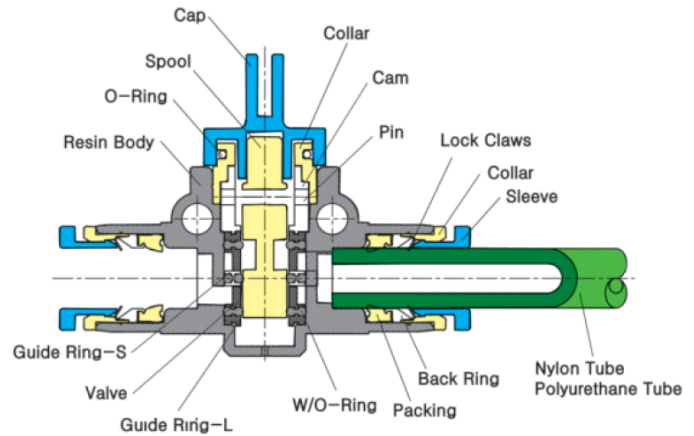

Specifications		
Fluid	AIR (No other gases or liquids)	
Working Pressure Range	0 ~ 284 psi	0 ~ 1958 kPa
Negative Pressure	-14.5 psi	-100 kPa
Temperature Range	32 ~ 176F	0 ~ 80C
Applicable Tubing	Polyurethane and Nylon	

**Model (R-R)**

**HVSS**  
NIPPLE

**R (BSPT) - R (BSPT)**    **R (BSPP) - R (BSPP)**

GHVSS 01-01	GHVSS G01-G01
GHVSS 02-01	GHVSS G02-G01
GHVSS 02-02	GHVSS G02-G02
GHVSS 03-02	GHVSS G03-G03
GHVSS 03-03	GHVSS G03-G03
GHVSS 04-03	GHVSS G04-G03
GHVSS 04-04	GHVSS G04-G04

**Model (ØD-R)**

**HVFS**  
STRAIGHT

**ØD (Metric) - R (BSPT)**    **ØD (Metric) - R (BSPP)**

GHVFS 06-01	GHVFS 06-G01
GHVFS 06-02	GHVFS 06-G02
GHVFS 06-03	GHVFS 06-G03
GHVFS 08-01	GHVFS 08-G01
GHVFS 08-02	GHVFS 08-G02
GHVFS 08-03	GHVFS 08-G03
GHVFS 10-02	GHVFS 10-G02
GHVFS 10-03	GHVFS 10-G03
GHVFS 10-04	GHVFS 10-G04
GHVFS 12-02	GHVFS 12-G02
GHVFS 12-03	GHVFS 12-G03
GHVFS 12-04	GHVFS 12-G04

**Model (R-ØD)**

**HVSF**  
STRAIGHT

**R (BSPT) - ØD (Metric)**    **R (BSPP) - ØD (Metric)**

GHVSF 01-06	GHVSF G01-06
GHVSF 01-08	GHVSF G01-08
GHVSF 02-06	GHVSF G02-06
GHVSF 02-08	GHVSF G02-08
GHVSF 02-10	GHVSF G02-10
GHVSF 02-12	GHVSF G02-12
GHVSF 03-06	GHVSF G03-06
GHVSF 03-08	GHVSF G03-08
GHVSF 03-10	GHVSF G03-10
GHVSF 03-12	GHVSF G03-12
GHVSF 04-10	GHVSF G04-10
GHVSF 04-12	GHVSF G04-12

**Model (ØD)**

**HVFF**  
UNION

**ØD (Metric)**

GHVFF 04-04
GHVFF 06-06
GHVFF 08-06
GHVFF 08-08
GHVFF 10-10
GHVFF 12-10
GHVFF 12-12

**Model (R-R)**

**HSV**  
SLIDE VALVE NIPPLE

**R (BSPT) - R (BSPT)**



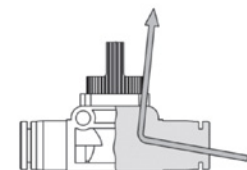

HSV M-01
HSV M-02
HSV M-03
HSV M-04
HSV M-06
HSV M-M5













### ► 3 Way Direction, 2 Way Direction







- The three-way direction control valve, when the air is stopped, discharges residual pressure to the outlet, which assures safety in repairing or adjusting connected devices.
- The two-way direction control valve does not discharge residual pressure, and is suitable for a reservoir tank or other device that does not require a discharging residual pressure.
- The two-way direction control valve is also suitable for the system where a vacuum pipe is used.



Model				
<b>SSBM</b> STAINLESS STEEL MUFFLER 	<b>SCM</b> SPEED CONTROL MUFFLER 	<b>SSSCM</b> STAINLESS STEEL SPEED CONTROL MUFFLER 	<b>SPBMS</b> SPEED CONTROL BRONZE MUFFLER 	<b>BHFA</b> FREE FLOW STRAINER 
<b>Thread (NPT) Bag Qty</b>	<b>Thread (NPT) Bag Qty</b>	<b>Thread (NPT) Bag Qty</b>	<b>Thread (NPT) Bag Qty</b>	<b>Thread (NPT) Bag Qty</b>
SSBM-08 ..... 5 SSBM-18 ..... 5 SSBM-28 ..... 5 SSBM-38 ..... 2 SSBM-48 ..... 2 SSBM-68 ..... 1 SSBM-88 ..... 1	SCM-08 ..... 10 SCM-18 ..... 10 SCM-28 ..... 10 SCM-38 ..... 10 SCM-48 ..... 5 SCM-68 ..... 1 SCM-88 ..... 1	SSSCM-18 ..... 5 SSSCM-28 ..... 5 SSSCM-38 ..... 2 SSSCM-48 ..... 2 SSSCM-68 ..... 1 SSSCM-88 ..... 1	SPBMS-18 ..... 5 SPBMS-28 ..... 5 SPBMS-38 ..... 5 SPBMS-48 ..... 5	BHFA-18 ..... 10 BHFA-28 ..... 10 BHFA-38 ..... 10 BHFA-48 ..... 5

Model				
<b>BM</b> SINTERED BRONZE MUFFLER 	<b>BMS</b> SINTERED BRONZE MUFFLER 	<b>FBMS</b> FEMALE SINTERED BRONZE MUFFLER 	<b>BV</b> BREATHER VENT 	<b>BVCH</b> BREATHER PLUG 
<b>Thread (NPT) Bag Qty</b>	<b>Thread (NPT) Bag Qty</b>	<b>Thread (NPT) Bag Qty</b>	<b>Thread (NPT) Bag Qty</b>	<b>Thread (NPT) Bag Qty</b>
BM-08 ..... 10 BM-16 ..... 10 BM-18 ..... 10 BM-28 ..... 10 BM-38 ..... 10 BM-48 ..... 5 BM-68 ..... 1 BM-88 ..... 1	BM-SAE#6 BM-SAE#8 BM-SAE#12 BMS-18 ..... 10 BMS-28 ..... 10 BMS-38 ..... 10 BMS-48 ..... 5 BMS-68 ..... 1 BMS-88 ..... 1 BMS-128 ..... 1 BMS-148 ..... 1 BMS-200 ..... 1	BMS-08-NP ..... 10 BMS-18-NP ..... 10 BMS-28-NP ..... 10 BMS-38-NP ..... 10 BMS-48-NP ..... 10 BMS-68-NP ..... 5 BMS-88-NP ..... 1	FBMS-18 ..... 5 FBMS-28 ..... 5 FBMS-38 ..... 5 FBMS-48 ..... 5 BV-08 ..... 10 BV-18 ..... 10 BV-28 ..... 10 BV-38 ..... 10 BV-48 ..... 5 BV-68 ..... 1 BV-88 ..... 1	BV-08 ..... 10 BV-18 ..... 10 BV-28 ..... 10 BV-38 ..... 10 BV-48 ..... 5 BV-68 ..... 1 BV-88 ..... 1 BV-CH-18 ..... 5 BV-CH-28 ..... 5 BV-CH-38 ..... 5 BV-CH-48 ..... 5 BV-CH-68 ..... 5 BV-CH-88 ..... 1 BV-CH-SAE#4 BV-CH-SAE#6 BV-CH-SAE#8 BV-CH-SAE#10 BV-CH-SAE#12

Model				
<b>BVS</b> BREATHER VENT 	<b>FBVS</b> FEMALE BREATHER VENT 	<b>SBN</b> SCREEN BREATHER VENT 	<b>SSSBN</b> STAINLESS STEEL SCREEN BREATHER VENT 	<b>SSBV</b> STAINLESS STEEL BREATHER VENT 
<b>Thread (NPT) Bag Qty</b>	<b>Thread (NPT) Bag Qty</b>	<b>Thread (NPT) Bag Qty</b>	<b>Thread (NPT) Bag Qty</b>	<b>Thread (NPT) Bag Qty</b>
BVS-18 ..... 10 BVS-28 ..... 10 BVS-38 ..... 10 BVS-48 ..... 10 BVS-68 ..... 5 BVS-88 ..... 1 BVS-128 ..... 1 BVS-148 ..... 1 BVS-200 ..... 1	BVS-08-NP ..... 10 BVS-18-NP ..... 10 BVS-28-NP ..... 10 BVS-38-NP ..... 10 BVS-48-NP ..... 10 BVS-68-NP ..... 5 BVS-88-NP ..... 1 BVS-128-NP ..... 1 BVS-148-NP ..... 1 BVS-200-NP ..... 1 FBVS-18 ..... 5 FBVS-28 ..... 5 FBVS-38 ..... 5 FBVS-48 ..... 5	SBN-18 ..... 10 SBN-28 ..... 10 SBN-38 ..... 10 SBN-48 ..... 10 SBN-68 ..... 5 SBN-88 ..... 1	SSSBN-18-316 ..... 5 SSSBN-28-316 ..... 5 SSSBN-38-316 ..... 2 SSSBN-48-316 ..... 2 SSSBN-68-316 ..... 1 SSSBN-88-316 ..... 1	SSBV-18 ..... 5 SSBV-28 ..... 5 SSBV-38 ..... 2 SSBV-48 ..... 2 SSBV-68 ..... 1 SSBV-88 ..... 1

Model					
<b>PGV</b> PLUG BREATH VENT 	<b>HIF</b> HYDRAULIC INLINE FILTER 	<b>HIL</b> HYDRAULIC INLINE FILTER 	<b>RIF</b> REPAIRABLE INLINE FILTER 	<b>NIF</b> NIPPLE INLINE FILTER 	<b>PS</b> PRESSURE SNUBBER 
<b>Thread (NPT) Bag Qty</b>	<b>Thread (NPT) Bag Qty</b>	<b>Thread (NPT) Bag Qty</b>	<b>Thread (NPT) Bag Qty</b>	<b>Thread (NPT) Bag Qty</b>	<b>Thread (NPT) Bag Qty</b>
PGV-18 ..... 10 PGV-28 ..... 10 PGV-38 ..... 10 PGV-48 ..... 5	HIF-28 ..... 2 HIF-38 ..... 2 HIF-48 ..... 2 HIF-68 ..... 2 HIF-SAE6 ..... 2 HIF-SAE8 ..... 2	HIF-28V ..... 2 HIF-38V ..... 2 HIF-48V ..... 2 HIF-68V ..... 2 HIF-SAE6V ..... 2 HIF-SAE8V ..... 2	HIL-28 ..... 2 HIL-38 ..... 2 HIL-SAE6 ..... 2 HIL-28V ..... 2 HIL-38V ..... 2 HIL-SAE6V ..... 2	RIF-18 ..... 5 RIF-28 ..... 5 RIF-38 ..... 5 RIF-48 ..... 5 RIF-68 ..... 1 RIF-48F RIF-68F	NIF-18 ..... 5 NIF-28 ..... 5 NIF-38 ..... 5 NIF-48 ..... 5 PS-28 ..... 5 PS-38 ..... 5



# AIR GUNS AND TUBING

## PRODUCT CODE SYSTEM

	U	-	1/4	(100F	BK)
(1) Type	1		2	3	4

(1) Type

(2) Tube Diameter (ØD)

Inch Size	
Code	Outer Dia
1/8	1/8"
5/32	5/32"
3/16	3/16"
1/4	1/4"
5/16	5/16"
3/8	3/8"
1/2	1/2"

Metric Size		
Code	Outer Dia	Inner Dia
04020	4 mm	2 mm
04025	4 mm	2.5 mm
06040	6 mm	4 mm
08050	8 mm	5 mm
10065	10 mm	6.5 mm
12080	12 mm	8 mm
16110	16 mm	11 mm
16120	16 mm	12 mm

(3) Length

Code	Length
100F	100 ft
500F	500 ft
50M	50 m
100M	100 m
200M	200 m
S	25 mm Nozzle
M	105 mm Nozzle
L	221 mm Nozzle

(4) Color

Code	Color
BK	Black
BU	Blue
C	Clear
G	Green
R	Red
W	White
Y	Yellow

# POLYURETHANE TUBING

## APPLICATION:

- Used for piping air tools, industrial machinery and various other pneumatic systems

## FEATURES:

- Higher flexibility than nylon while offering superior kink resistance and overall strength

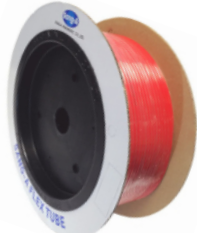
Model (ØD)	Tube (ØD)	
	Inch O.D.	Metric O.D. - I.D.
<b>U</b> POLYURETHANE TUBING 	U 1/8(100F *)	U-04020(200M *)
	U 1/8(500F *)	U-04025(200M *)
	U 5/32(100F *)	U-06040(100M *)
	U 5/32(500F *)	U-08050(100M *)
	U 3/16(100F *)	U-10065(100M *)
	U 3/16(500F *)	U-12080(100M *)
	U 1/4(100F *)	U-16110(50M *)
	U 1/4(500F *)	U-16120(50M *)
	U 5/16(100F *)	
	U 5/16(500F *)	
	U 3/8(100F *)	
	U 3/8(500F *)	
	U 1/2(100F *)	
	U 1/2(500F *)	

\* Refer to Product Code System for available colors

## Working Pressure

- Temperature limits of tube : -40°C~80°C
- Normal Pressure : Control normal pressure within 1/3 of tube burst pressure.

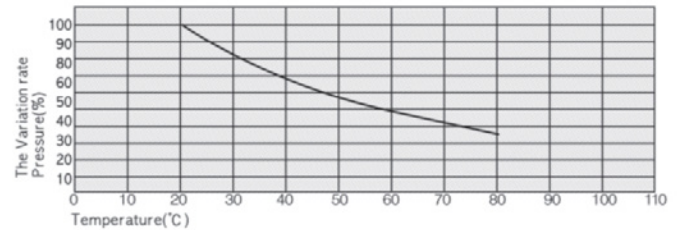

# AIR GUNS

## APPLICATION:

- Used for cleaning debris and particles with compressed air

## FEATURES:

- Various nozzle sizes allow ease of cleaning in confined spaces

Model (ØD-Rc)	ØD (Metric) - Rc (BSPT)
<b>AG-S</b> 	AIR GUN 0802 S(BK)
	AIR GUN 0802 S(BU)
	AIR GUN 0802 S(R)
	AIR GUN 1002 S(BK)
	AIR GUN 1002 S(BU)
	AIR GUN 1002 S(R)
	AIR GUN 1003 S(BK)
	AIR GUN 1003 S(BU)
	AIR GUN 1003 S(R)

Model (ØD-Rc)	ØD (Metric) - Rc (BSPT)
<b>AG-M</b> 	AIR GUN 0802 M(BK)
	AIR GUN 0802 M(BU)
	AIR GUN 0802 M(R)
	AIR GUN 1002 M(B)
	AIR GUN 1002 M(BU)
	AIR GUN 1002 M(R)
	AIR GUN 1003 M(BK)
	AIR GUN 1003 M(BU)
	AIR GUN 1003 M(R)

Model (ØD-Rc)	ØD (Metric) - Rc (BSPT)
<b>AG-L</b> 	AIR GUN 0802 L(BK)
	AIR GUN 0802 L(BU)
	AIR GUN 0802 L(R)
	AIR GUN 1002 L(BK)
	AIR GUN 1002 L(BU)
	AIR GUN 1002 L(R)
	AIR GUN 1003 L(BK)
	AIR GUN 1003 L(BU)
	AIR GUN 1003 L(R)

---

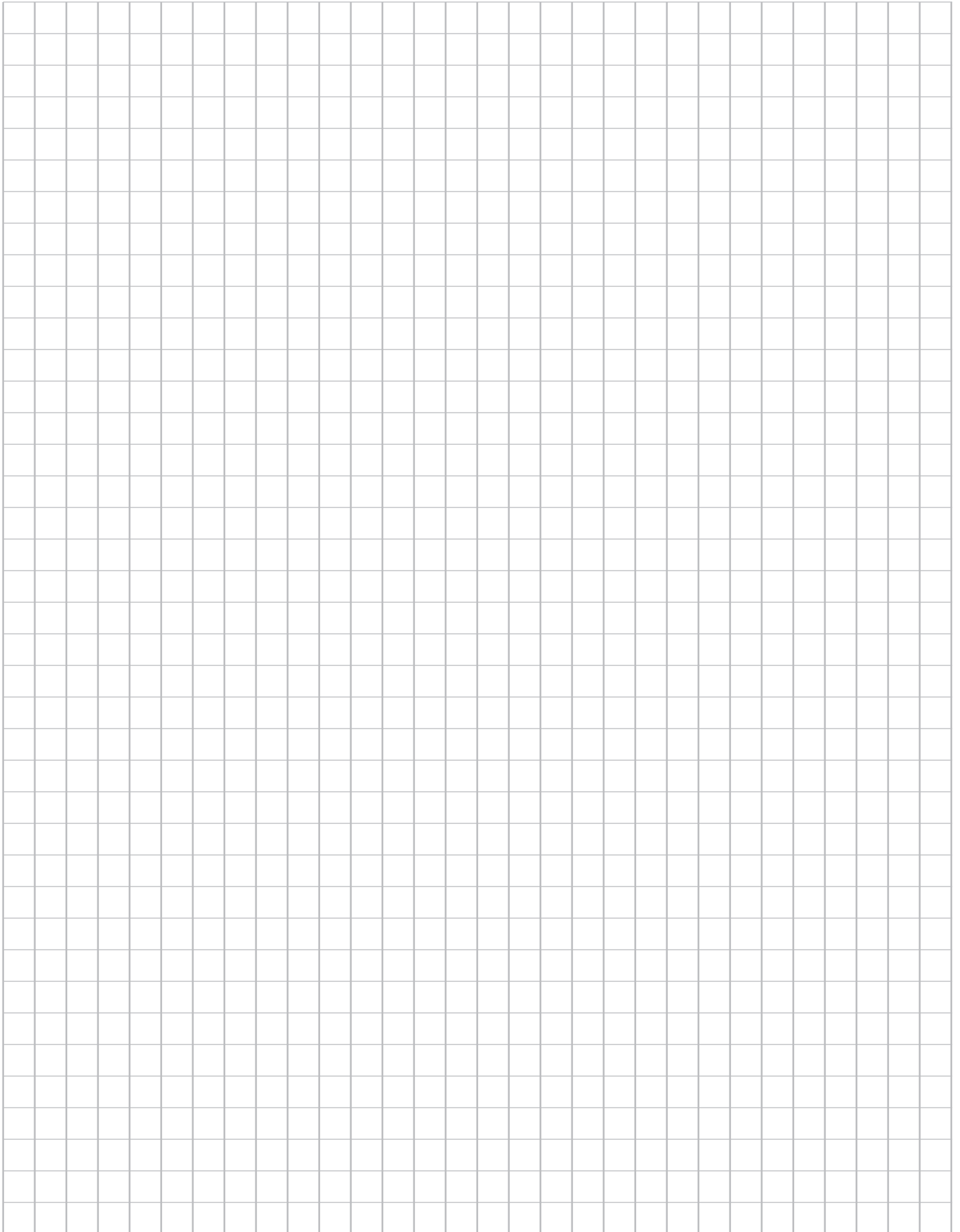
A large, empty grid of small squares occupies the central portion of the page. The grid is composed of 20 columns and 30 rows of squares, providing a space for calculations or data entry.



390 Amapola Av. Suite #1, Torrance, CA 90501 USA  
(310) 320-3748 (Main) (310) 320-3436 (Fax)  
EMAIL: [info@spctrade.com](mailto:info@spctrade.com)