

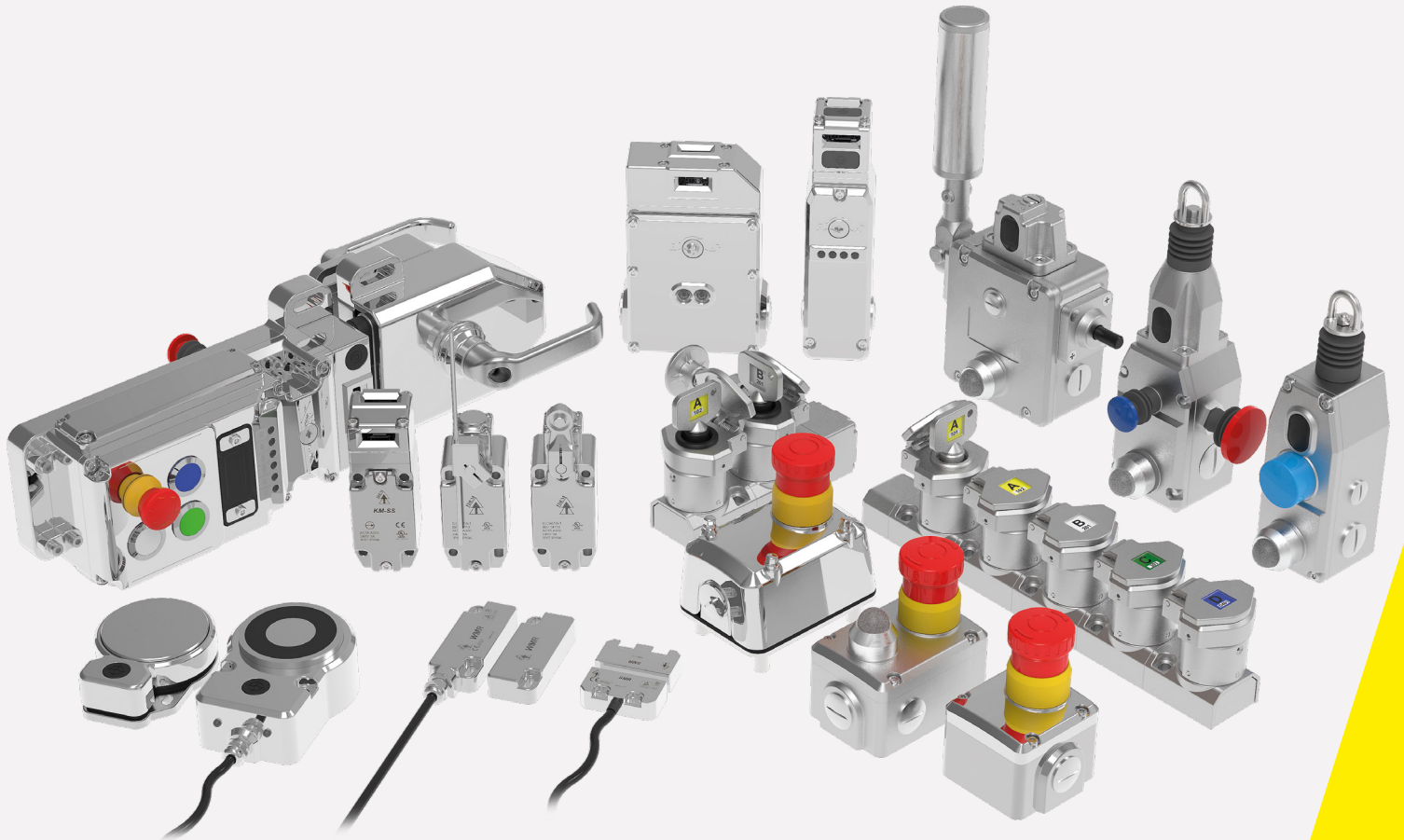

IDEM SAFETY
Making Industry Safer



NEW PRODUCTS
PAGES 4,5,8,9



Safety Products for Food and Beverage Manufacturing

Industry Overview Brochure



What We Do

IDEM designs and manufactures machine safety products, that make industry safer.



Proud Winners of

The Queen's Award for Enterprise: International Trade 2022

The King's Award for Enterprise: Innovation 2023

Our History

1985

The founder of IDEM, Medi Mohtasham begins his employment at EJA Engineering where he designed Trojan, Atlas, Rotacam and LRS1 under the Guardmaster brand. Rockwell Automation acquires EJA in 1996.

2003

Medi leaves his position as Technical Director of Rockwell to create IDEM Safety Switches, with the vision to develop the 'Next Generation' of Safety Switches, designed and manufactured in the UK.

2005

IDEM manufactures the GuardianLine range of safety rope switches, specialising in products for the Food Industry, Explosion Proof applications and Factory Automation.

Present

Today IDEM operates globally, providing reliable, cost-effective safety interlock solutions that save lives. IDEM continues to invest in new ways to protect your personnel and improve your productivity.

Why Choose IDEM?



Global leadership in the design and manufacture of machine safety products since 1985.



IDEM's global headquarters is based in the UK with offices in the USA and Europe.



Privately owned business with in house sales, R&D and technical support teams.



Renowned for world-class product quality and reliability on a global scale.



State-of-the-art manufacturing and test facilities. This includes Ingress Protection (IP) and Shock testing.



Exceptional delivery time for both small and large orders. We put the customers' needs first.

SETTING THE STANDARD IN MACHINE SAFETY SWITCHES

1 SAFETY

One-third of all fatalities in the food and drink industries relate to plant and machinery; no other single cause accounts for as many deaths. Furthermore, a significant proportion of non-fatal injuries are also due to machinery.

At IDEM, we understand there are many different applications that require different methods of interlocking. That is why we have developed the world's largest range of machine guard safety products in 316 Stainless Steel to help you achieve your safety and hygiene requirements.



2 HYGIENE

We understand the issues specific to this industry therefore, our safety switches will be safe, standards-compliant and resistant to harsh cleaning solutions.

ALL IDEM 316 grade stainless steel products are suitable for use up to IP69K. We have also developed products suitable for Zone 1 - Food Contact, reducing the likelihood of bacteria build up.

3 WHAT ARE FOOD HYGIENE ZONES?

ZONE 1: FOOD ZONE

These are areas where equipment regularly and predictably comes in contact with food as it being produced. Food conveyors, mixers, nozzles and cooking surfaces are examples of Hygienic Design environments. Bringing safety to these zones brings a unique challenge as it represents the highest probability of product contamination if a pathogen were present on the equipment.

ZONE 3: NON-FOOD CONTACT ZONE

This zone includes Non-Food Contact Surfaces. Surfaces that under normal operating procedures do not contact surfaces of the food or container.

ZONE 2: SPRAY ZONE

These areas immediately surround the food production zone; dripping product or run off from equipment can cause product contamination. This zone is regularly cleaned as part of any plant Hygiene Plan. Equipment used in this area need to withstand harsh cleaning processes and be designed in a way that is consistent with good sanitary food design machine practices, eliminating areas where moisture and debris can collect.

NON-CONTACT SAFETY SWITCHES

Designed and manufactured to the highest quality, our non-contact safety switches are available in 3 technology types; magnetic and reed, coded magnetic - solid state and RFID. The surface is mirror polished and markings are laser etched for ease of cleaning.

STAINLESS STEEL BACKPLATE

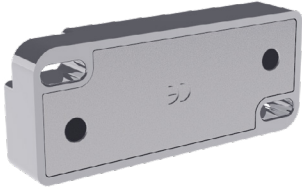

All IDEM stainless steel safety switches include a back cover.

This protects the encapsulation from corrosive chemicals, reducing the likelihood of water ingress.

INTERNAL PROTECTION HOUSING



The PCB is encased in a high specification polyester before being placed into the metal housing and encapsulated.

This reduces the likelihood that the internal electronics will short out on the casting, and reduces the affects of high/low temperatures on the switch.



MMR



- Left or Right Cable Entry
- Magnet and Reed Operation
- 22mm Fixing Holes
- Suitable for Zones 2 and 3



MMC



- Left or Right Cable Entry
- Coded Magnetic, Solid State
- Guard Status Indication
- 22mm Fixing Holes
- Suitable for Zones 2 and 3



SMR



- Magnet and Reed Operation
- High Power, 1Amp Switching
- 22mm Fixing Holes
- Suitable for Zones 2 and 3



SMC



- Coded Magnetic, Solid State
- Guard Status Indication
- 22mm Fixing Holes
- Suitable for Zones 2 and 3



SMR-F



- Magnet and Reed Operation
- Underneath Fixing
- Suitable for Zones 1, 2 and 3



SMC-F



- Coded Magnetic, Solid State
- Guard Status Indication
- Underneath Fixing
- Suitable for Zones 1, 2 and 3



LMR



- Magnet and Reed Operation
- High Power, 1Amp Switching
- European Standard Fixing Holes
- Suitable for Zones 2 and 3



LMC



- Coded Magnetic, Solid State
- Guard Status Indication
- European Standard Fixing Holes
- Suitable for Zones 2 and 3



CMR



- Magnet and Reed Operation
- Industry Standard, Slim-Line
- High Power, 1 or 2 Amp Switching
- Suitable for Zones 2 and 3



CMC



- Coded Magnetic, Solid State
- Guard Status Indication
- Underneath Fixing
- Suitable for Zones 2 and 3



CMR-F



- Magnet and Reed Operation
- Underneath Fixing
- Suitable for Zones 1, 2 and 3



CMC-F



- Coded Magnetic, Solid State
- Guard Status Indication
- Underneath Fixing
- Suitable for Zones 1, 2 and 3

NON-CONTACT SAFETY SWITCHES



WMR



- Magnet and Reed Operation
- Industry Standard, Wide Body
- High Power, 1 or 2 Amp Switching
- Suitable for Zones 2 and 3



WMC



- Coded Magnetic, Solid State
- Guard Status Indication
- Industry Standard, Wide Body
- Suitable for Zones 2 and 3



RMR



- Magnet and Reed Operation
- M30 Threaded Barrel
- High Power, 1 or 2 Amp Switching
- Suitable for Zones 2 and 3



RMC



- Coded Magnetic, Solid State
- Guard Status Indication
- M30 Threaded Barrel
- Suitable for Zones 2 and 3



BMR



- Magnet and Reed Operation
- M18 Threaded Barrel
- High Power, 1 Amp Switching
- Suitable for Zones 2 and 3

RFID CODING



BMF



- RFID (High Coded EN14119)
- M18 Threaded Barrel
- Guard + Code Status LED
- Voltage Free Outputs
- Suitable for Zones 2 and 3



LMF



- RFID (High Coded EN14119)
- European Standard Fixing
- Guard + Code Status LED
- Voltage Free Outputs
- Suitable for Zones 2 and 3



BMZ



- RFID (High Coded EN14119)
- M18 Threaded Barrel
- Advanced LED Diagnostics
- Internal Self Monitoring + OSSD
- Suitable for Zones 2 and 3



LMZ



- RFID (High Coded EN14119)
- European Standard Fixing
- Advanced LED Diagnostics
- Internal Self Monitoring + OSSD
- Suitable for Zones 2 and 3

MOUNTING ACCESSORIES



GBN-1-SS



- 316 Stainless Steel Mounting Plate
- High Spec Polyester Handle
- Sliding Operation
- Left or Right Hand Versions
- Compatible with L and S Models



GBN-3-SS



- 316 Stainless Steel Mounting Plate
- High Spec Polyester Handle
- Sliding Operation (**Non Latching**)
- Left or Right Hand Versions
- Compatible with L and S Models

MMZ HYGIENIC RFID NON-CONTACT SAFETY SWITCH



The MMZ is the world's smallest **RFID** safety switch in mirror polished 316 stainless-steel tested to **IP69K**. It is suitable for monitoring doors, gates and other moveable safeguards in rigorous washdown environments.

The integrated **OSSD outputs** are suitable for series connection of up to 30 sensors, maintaining **CAT4, SIL3, PLe** in accordance with the latest international safety standards.

The RFID signal is available in any or unique code versions, fulfilling the requirements of **Type 4 High Level Coding** in accordance with EN ISO 14119.

Any Coding	Unique Coding
Any actuator will work at any time.	Factory paired, reattach procedure available up to 7 times.

Visible Indicators

The LED lens is moulded directly into the switch body, providing a smooth surface finish suitable for wet and dusty environments.

The lens wraps around the body for full visibility of all device states. The indication is easily recognisable, improving both product diagnosis and maintenance.

Verstile Mounting

The MMZ can be mounted on both faces, accommodating cable runs from the left and right.

This is ideal for applications with both left- and right-hand opening guards.



MMZ HYGIENIC RFID NON-CONTACT SAFETY SWITCH



We understand the rigorous cleaning processes involved in high hygiene environments. With that in mind, the MMZ has been designed with an innovative 2-stage wrap-around poly carbonate lens. This provides a perfectly smooth exterior, free from all contamination traps.

The MMZ is tested to **IP67** and **IP69K** and suitable for **SIP** and **CIP** cleaning processes.

The MMZ ensures reliable switching due to wide sensing distance.

It is also suitable for outdoor use as well as strict washdown environments, particularly food, beverage, and pharmaceutical manufacturing.

Simplify connectivity using our 8 port Z-range M12 connection block

Our Z-Range products feature OSSD technology, allowing the MMZ to maintain SIL3/PLe, even when connected in series. The Z-Range M12 connection block features plug and play connectivity which drastically reduces installation time.

- LED Indication for each port
- 2 Safety Outputs back to the safety controller
- 8 auxiliary outputs for external indication



Switch

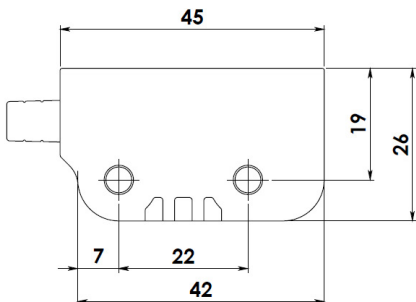

Actuator

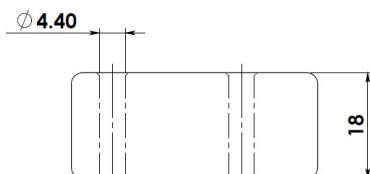
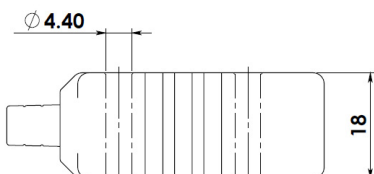
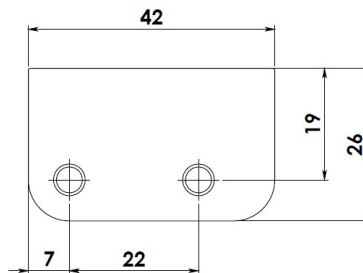

SOLENOID CONTROLLED SAFETY INTERLOCKS

Designed and manufactured to the highest quality, we are the only company in the world with solenoid controlled interlocks in 316 stainless-steel. The IP69K rating and mirror polished design means they are ideal for frequent washdown procedures.

MECHANICAL EXCELLENCE

Every IDEM tongue switch uses a patented cam system. The unique design provides a level of anti-tamper and long term reliability, even during frequent use.

IDEAL FOR USE ON HEAVY GATES

Heavy guards can put pressure on the solenoid, causing issues when trying to energise and open the gate. Our unique design will always allow the guard to open, regardless of how



KL1-SS



- 2000N Holding Force
- Rotating Head - 4 Entry Positions
- Up to 2 LED's
- M20 or 1/2" NPT
- Suitable for Zones 2 and 3

5



KL3-SS



- 3000N Holding Force
- Rotating Head - 8 Entry Positions
- 2 LED's Solenoid and Lock Status
- M20 or 1/2" NPT
- **Rear Release Available**
- **Power-to-Lock Available**
- Suitable for Zones 2 and 3



KL4-SS



- 3000N Holding Force
- Rotating Head - 8 Entry Positions
- 2 LED's Solenoid and Lock Status
- Optional Request Button
- M20 or 1/2" NPT
- **Rear Release Available**
- Suitable for Zones 2 and 3



KLT-SS



- 3000N Holding Force
- Rotating Head - 4 Entry Positions
- 2 LED's Solenoid and Lock Status
- M20 or 1/2" NPT
- **Rear Release Available**
- **Power-to-Lock Available**
- Suitable for Zones 2 and 3

RFID CODING



KLT-SS-RFID



- RFID (High Coded EN14119)
- 3000N Holding Force
- Rotating Head - 4 Entry Positions
- Guard + Code Status LED
- Voltage Free Outputs
- M20 or 1/2" NPT
- **Rear Release Available**
- Suitable for Zones 2 and 3

RFID CODING WITH OSSD OUTPUTS



6

KL3-SS-Z



- RFID (High Coded EN14119)
- 3000N Holding Force
- Rotating Head - 8 Entry Positions
- Advanced LED Diagnostics
- Internal Self Monitoring + OSSD
- M20 or 1/2" NPT
- **Rear Release Available**
- Suitable for Zones 2 and 3



STANDARD (140107)



FLEXIBLE (140111)



FLEXIBLE RFID (140186)



ACCESSORIES AND HOW TO USE THEM

SLIDING HANDLE WITH REAR ESCAPE

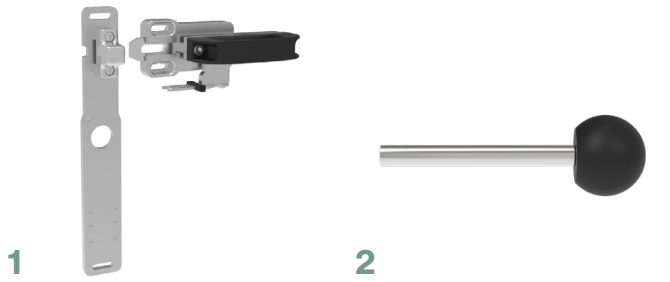

1 GBL-1-SS SLIDING GATE BOLT

- 316 Stainless Steel Mounting Plate
- High Spec Polyester Handle
- Sliding Operation
- Left or Right Hand Versions
- For use with KL3-SS

2 REAR SLIDING HANDLE (211005)

- 316 Stainless Steel Rod
- High Spec Polyester Handle
- For use with GBL-1-SS



3 SPRING CATCH (211006)

- 316 Stainless Steel Shaft
- High Spec Polyester Catch
- Stops GBL-1-SS Re-Latching

4 CABLE GLAND

- 316 Stainless Steel Construction
- M20 or 1/2" NPT
- Highly Recommended to Ensure IP69K Seal

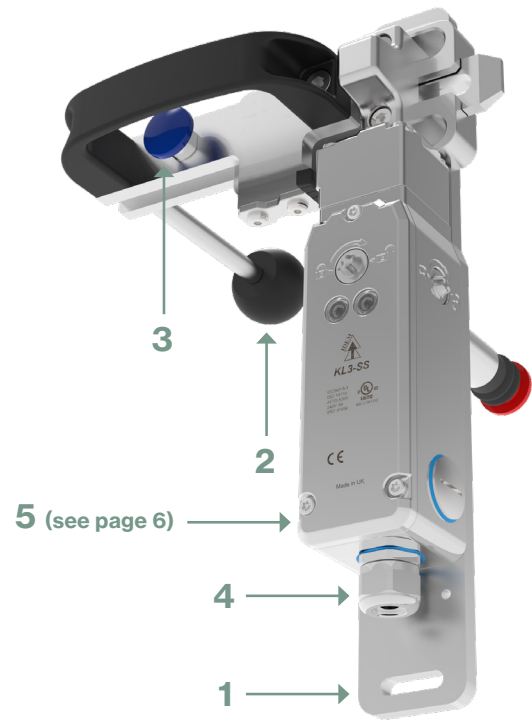

HIGHEST LEVEL OF FUNCTIONAL SAFETY



This solution provides CAT4, SIL4, PLe in accordance with the latest international standards. It is the only 316 stainless steel RFID safety switch on the market.

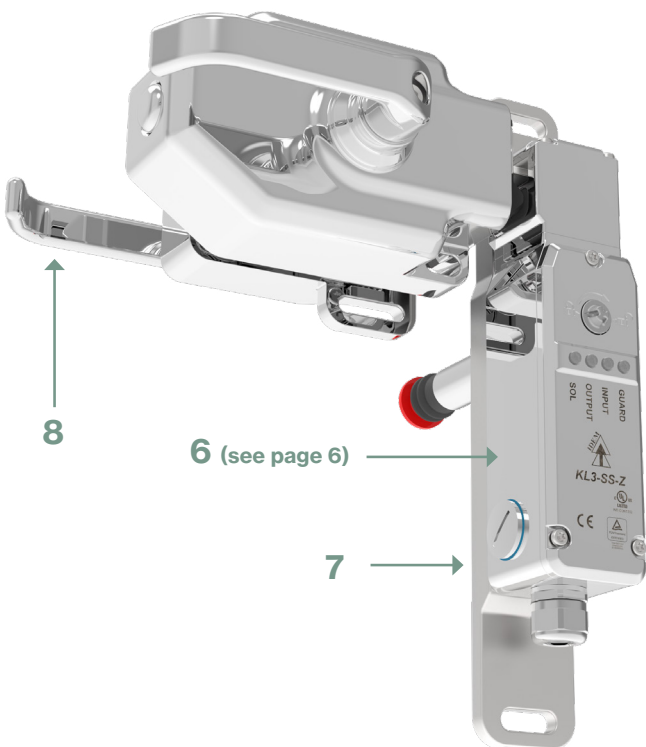

7 GBZ-SS ROTARY HANDLE

- 100% 316 Stainless Steel
- Rotary Operation
- Left or Right Hand Versions
- For use with KL3-SS-Z

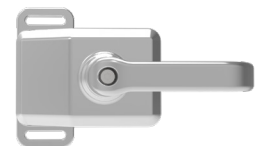

8 REAR ROTARY HANDLE

- 100% 316 Stainless Steel
- Left or Right Hand Versions
- For use with GBZ-SS

MLZ HYGIENIC LOCKING SWITCH WITH RFID



Small but mighty.

The MLZ is a compact 30mm-wide hygienic safety locking switch housed in mirror polished 316 stainless steel. It features versatile mounting with choice of 3 RFID coded entry points and **OSSD outputs** for series connection. The device's super-compact design means it is compatible with the narrowest of machine guard rails and requires no mounting plate, making it simple to install and maintain.

The MLZ's diminutive size belies its strength and durability, with an impressive **4000N holding force** when locked.

Tested to **IP67 and IP69K** and suitable for **SIP and CIP** cleaning, this robust interlock is ideal for outdoor use as well as for strict washdown environments, particularly food contact, beverage,



RFID CODED TONGUE

- RFID technology meets the requirements of Type 4 high level coding

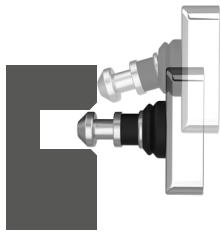

FLEXIBLE TONGUE

- 316 stainless-steel construction
- Flexible tongue for misaligned guards



ADJUSTABLE LATCH

- Adjustable latch mechanism for smooth unlocking of all door types (avoids nuisance tripping)

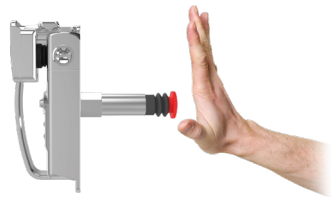

REAR ESCAPE

- Optional rear escape
- Can be fitted easily by the end user.

Seamless Integration.

The MLZ's compact design and 3-way head actuation means it can be integrated onto any machine guard door. The flexible actuator and adjustable latch mechanism supports misaligned guards.



EMERGENCY STOPS

The world's largest range of emergency stop devices in 316 stainless steel. The double seal gasket on the lids ensures the IP69K seal.



ES-SS



- Mirror Polished Finish
- 2 x M20 or 1/2" NPT Conduit
- Replaceable 3-Pole Contact Block
- Suitable for Zones 2 and 3



ES-SS(P)



- Mirror Polished Finish
- 2 x M20 or 1/2" NPT Conduit
- Replaceable 3-Pole Contact Block
- Button Shroud
- Suitable for Zones 2 and 3



ESL-SS



- Larger Bodied Design
- 3 x M20 or 1/2" NPT Conduit
- Replaceable 4-Pole Contact Block
- Suitable for Zones 2 and 3



ESL-SS(P)



- Larger Bodied Design
- 3 x M20 or 1/2" NPT Conduit
- Replaceable 4-Pole Contact Block
- Button Shroud
- Suitable for Zones 2 and 3



ESL-SS(L)



- LED Indication
- 3 x M20 or 1/2" NPT Conduit
- Replaceable 4-Pole Contact Block
- Suitable for Zones 2 and 3



ESL-SS(LP)



- LED Indication
- 3 x M20 or 1/2" NPT Conduit
- Replaceable 4-Pole Contact Block
- Button Shroud
- Suitable for Zones 2 and 3

INTERNAL SAFETY LATCH

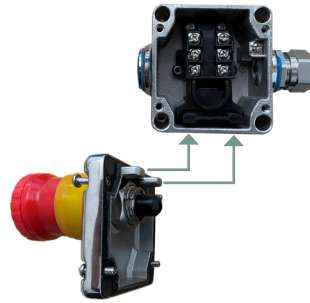

A special lid safety trip mechanism means that the safety contacts will open if the lid is removed.

This provides an extra degree of anti-tamper.

ESL-SS-WR ZONE 1 SUITABLE EMERGENCY STOP



Unique to IDEM, the ESL-SS-WR is the only emergency stop on the market suitable for zone 1 applications.

Sloped sides to reduce liquid build-up on the surface

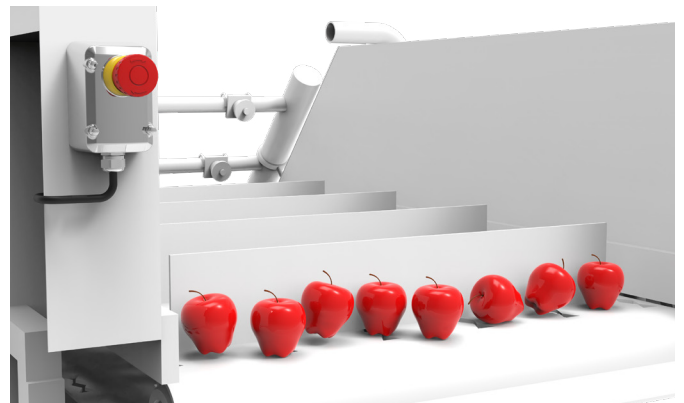
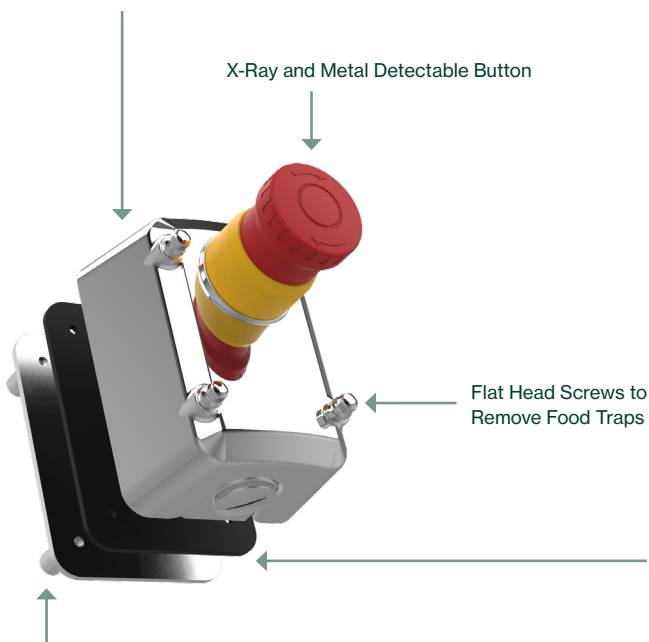

RUBBER SEAL (239300)



SPACER KIT (239301)

SAFETY ROPE PULL SWITCHES

Reliable safety rope switches housed in 316 stainless steel and tested to IP69K. All IDEM rope switches are available with LED indication.



GLM-SS



- Protection up to 50M
- Optional LED Indication
- Optional Emergency Stop
- 2 x M20 or 1/2" NPT Conduit
- Suitable for Zones 2 and 3



GLHD-SS



- Protection up to 125M Each Side
- Optional LED Indication
- Optional Emergency Stop
- 4 x M20 or 1/2" NPT Conduit
- Suitable for Zones 2 and 3



GLHL-SS



- Protection up to 125M (Left)
- Optional LED Indication
- Optional Emergency Stop
- 4 x M20 or 1/2" NPT Conduit
- Suitable for Zones 2 and 3



GLHR-SS



- Protection up to 125M (Right)
- Optional LED Indication
- Optional Emergency Stop
- 4 x M20 or 1/2" NPT Conduit
- Suitable for Zones 2 and 3



GLS-SS



- Protection up to 100M
- Optional LED Indication
- Optional Emergency Stop
- 3 x M20 or 1/2" NPT Conduit
- Suitable for Zones 2 and 3

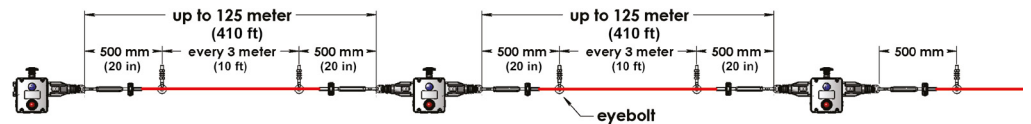
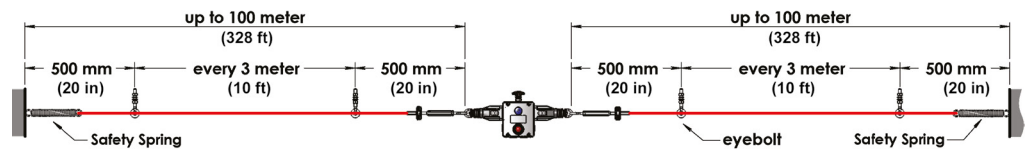

STAINLESS STEEL ROPE ACCESSORIES



TENSIONER (140019)



PULLEY (140021)



SAFETY SPRING (140043)



EYEBOLTS

- 3-Pack (140096)
- 8-Pack (140045)



KITS (ROPE + ACCESSORIES)

5, 10, 15, 20, 30, 50, 60, 80, 100, 125



FLEXIBLE EYEBOLT



PIGTAIL EYEBOLTS



QUICK LINK (140079)

TRAPPED KEY INTERLOCKS

IDEM's Trapped-key interlocks utilise locks and coded keys for sequential control of equipment and machinery to ensure safe operation.

CONTROL / ISOLATION

The first stage of any trapped key system is to isolate the power or control circuit. This should STOP any hazardous processes.

KEY EXCHANGE

The second stage is exchange. The isolator key can be used to open 1 access lock at a time or, if there are multiple access locks, a key exchange

ACCESS CONTROL

Access locks prevent entry to the hazardous areas. Only when the correct coded key is presented, will entry be permitted.

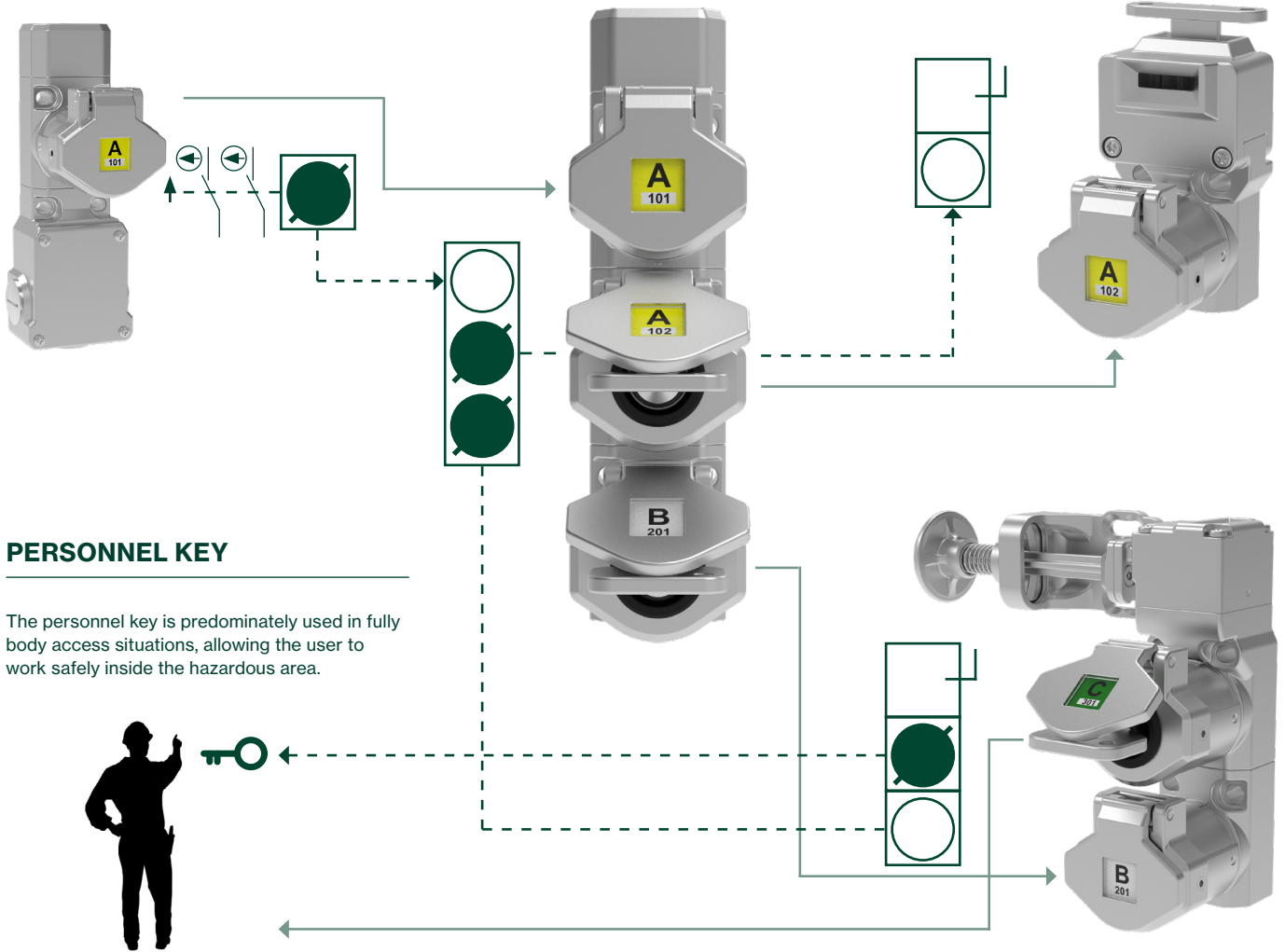

PERSONNEL KEY

The personnel key is predominately used in fully body access situations, allowing the user to work safely inside the hazardous area.



CONTROL SWITCH ISOLATION

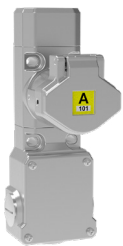

SS-ISB-CB



- Monitored Control Switch.
- 2nc 2no, 3nc 1no or 4nc Contacts
- 240V 3A Max
- Die-Cast (IP67)
- 316 Stainless Steel (IP69K)



SS-TS-CB



- Key trapped, actuator unlocked.
- 2nc 2no, 3nc 1no or 4nc Contacts
- 240V 3A Max
- Available with either 1/2" NPT or M20 conduit entry.

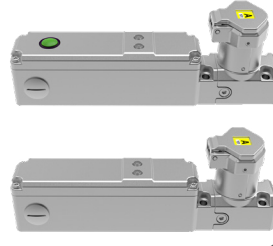

SS-ISB4-SKR



- 2nc 2no, 3nc 1no or 4nc Contacts
- 240V 3A Max
- 24V ac/dc solenoid voltage
- Guard Status LED
- Available with integral request button



TRAPPED KEY INTERLOCKS

KEY EXCHANGE

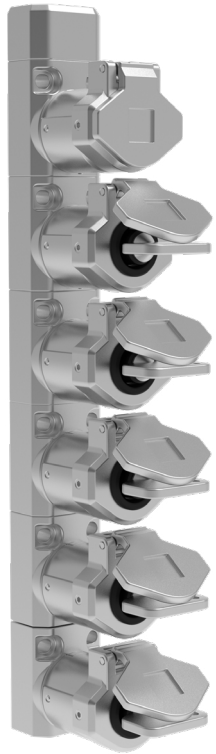

Part Number	Key Exchange - 316 Stainless Steel	
SS-KE-NS2	2 Keys	First Key Trapped All remaining keys can be released non-sequentially
SS-KE-NS3	3 Keys	
SS-KE-NS4	4 Keys	
SS-KE-NS5	5 Keys	
SS-KE-NS6	6 Keys	

LARGER SYSTEMS



MX-P-8-2X6 PANEL MOUNTED
MX-B-8-2X6 BOX MOUNTED

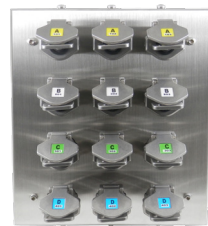

MX-P-12-3X9 PANEL MOUNTED
MX-B-12-3X9 BOX MOUNTED



MX-P-20-5X15 PANEL MOUNTED
MX-B-20-5X15 BOX MOUNTED

ACCESS CONTROL

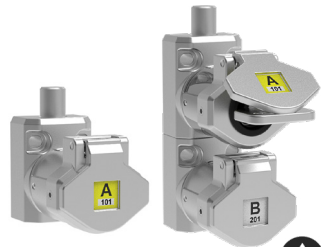

SS-BS / SS-BD-11



- 1 Key Trapped, Bolt Retracted or 1 key Trapped, 1 Key Released
- 316 Stainless Steel

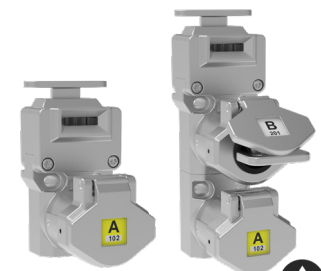

SS-TS / SS-TD-11



- Key Trapped, Actuator Unlocked or 1 Key Trapped, 1 Key Released
- 316 Stainless Steel

LATEST VERSION



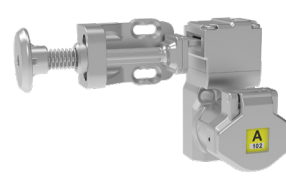

HT-S-L (LEFT)/HT-S-R (RIGHT)

- 1 key trapped when unlocked
- 316 Stainless Steel

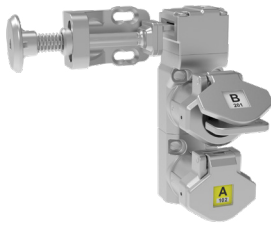

HT-D-R-11 (RIGHT)/HT-D-R-11 (LEFT)

- 1 key trapped, 1 released
- 316 Stainless Steel

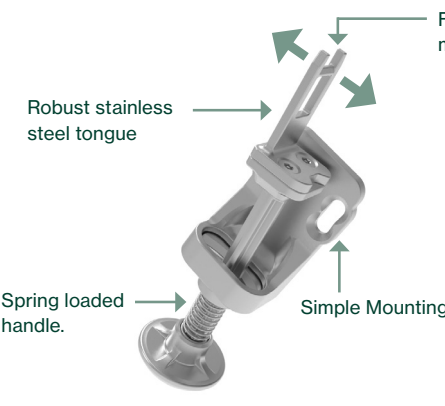

Robust stainless steel tongue

Spring loaded handle.

Simple Mounting

Flexible actuator for misaligned guards.

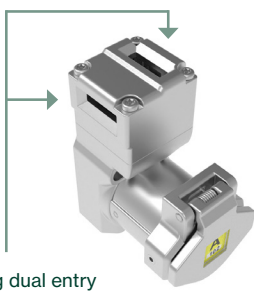

360 degrees rotating dual entry head with Anti-Tamper cam system.

ELECTROMAGNETIC RFID SAFETY SWITCHES

The tongue entry point on solenoid controlled interlocks can act as a food trap for potential contamination. The MGL has a smooth mirror polished surface and a non-contact style operation.

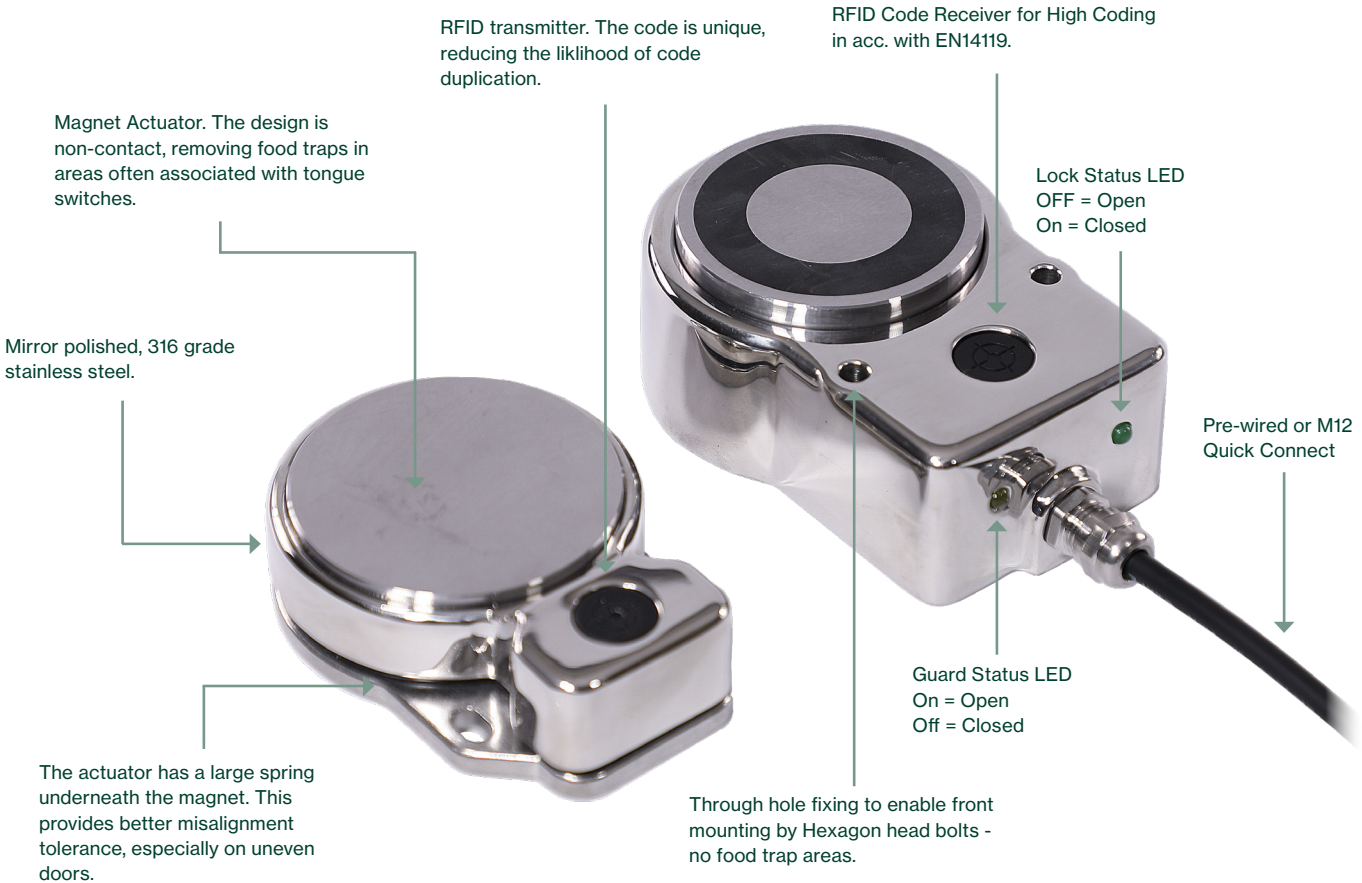

APPLICATION

Industrial washing machine.



- MGL-2SS** 
- Mirror Polished Finish
 - 600N Holding Force
 - RFID Coding
 - 24Vdc Power-to-Lock
 - Suitable for Zones 2 and 3

- MGL-1SS** 
- Mirror Polished Finish
 - 1100N Holding Force
 - RFID Coding
 - 24Vdc Power-to-Lock
 - Suitable for Zones 2 and 3

MGL-1SS x 2 are used to hold two doors closed during the wash cycle. The doors are large and prone to heavy use and misalignment.

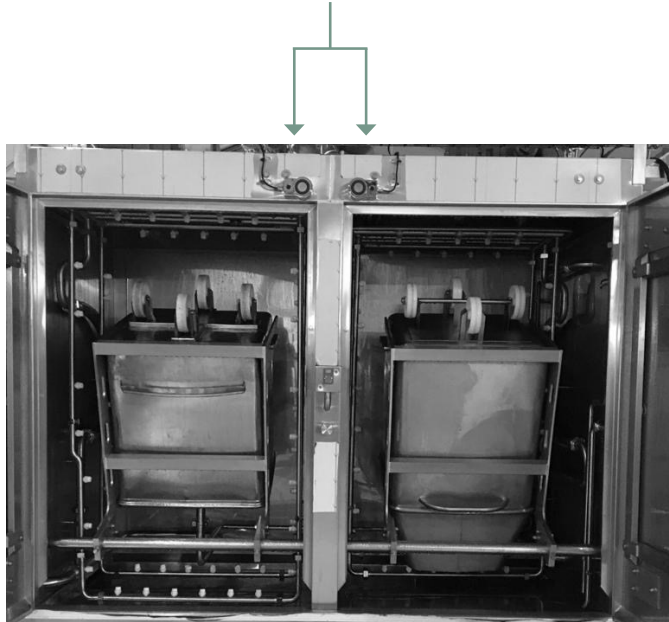
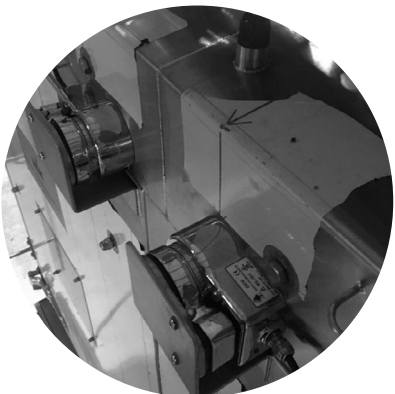

SAFETY LIMIT SWITCHES

The world's most comprehensive range of safety limit switches in 316 stainless steel. The precise construction and double seal gaskets means they are suitable for IP69K applications.



HLM-SS-AL LEVER ARM



- Lever Arm
- Mirror Polished Finish
- 1 x M20 or 1/2" NPT Conduit
- Positive opening NC safety contact to IEC60947-5-1
- Replaceable Contact Block
- Industry standard mounting to EN50041
- Suitable for Zones 2 and 3



HLM-SS-ARL



- Adjustable Roller Lever
- Mirror Polished Finish
- 1 x M20 or 1/2" NPT Conduit
- Positive opening NC safety contact to IEC60947-5-1
- Replaceable Contact Block
- Industry standard mounting to EN50041
- Suitable for Zones 2 and 3



HLM-SS-PP



- Pin Plunger
- Mirror Polished Finish
- 1 x M20 or 1/2" NPT Conduit
- Positive opening NC safety contact to IEC60947-5-1
- Replaceable Contact Block
- Industry standard mounting to EN50041
- Suitable for Zones 2 and 3



HLM-SS-RP



- Roller Plunger
- Mirror Polished Finish
- 1 x M20 or 1/2" NPT Conduit
- Positive opening NC safety contact to IEC60947-5-1
- Replaceable Contact Block
- Industry standard mounting to EN50041
- Suitable for Zones 2 and 3



HLM-SS-SRL



- Short Roller Lever
- Mirror Polished Finish
- 1 x M20 or 1/2" NPT Conduit
- Positive opening NC safety contact to IEC60947-5-1
- Replaceable Contact Block
- Industry standard mounting to EN50041
- Suitable for Zones 2 and 3



HLM-SS-SL



- Spring Lever
- Mirror Polished Finish
- 1 x M20 or 1/2" NPT Conduit
- Positive opening NC safety contact to IEC60947-5-1
- Replaceable Contact Block
- Industry standard mounting to EN50041
- Suitable for Zones 2 and 3



HLM-SS-TSL



- Telescopic Spring Lever
- Mirror Polished Finish
- 1 x M20 or 1/2" NPT Conduit
- Positive opening NC safety contact to IEC60947-5-1
- Replaceable Contact Block
- Industry standard mounting to EN50041
- Suitable for Zones 2 and 3

FOOD PROCESSING APPLICATION



Bakery machine application that utilises all IDEM stainless steel safety products, in particular the pin plunger limit switch. The IP69K seal and tolerance to heat make IDEM the number one choice for machinery within food and beverage manufacturing.

ATEX certified versions are available.

HINGE SAFETY SWITCHES

IDEM's Hinge Switches are housed in a hygienic, 316 grade stainless steel with a mirror polish finish. They fit directly to the hinged axis of machine guard doors, and provide a very high level of anti-tamper.



HC-SS



- Mirror Polished Finish
- 22mm Fixing Profile
- Rotation on 90 Degree Increments
- Solid and Hollow Shafts Available
- Suitable for Zones 1 and 2



HS-SS



- Mirror Polished Finish
- 800N Axial Holding Force
- 6-12 Degrees Adjustment
- 3NC + 1NO or 2NC + 2NO
- Suitable for Zones 1 and 2



HS-SS-Z



- Mirror Polished Finish
- 800N Axial Holding Force
- 6-12 Degrees Adjustment
- OSSD Outputs
- Advanced LED Indication
- Suitable for Zones 1 and 2



BLANK HINGE



- Mirror Polished Finish
- 800N Axial Holding Force



MOUNTING BRACKETS



- For front mounting when rear mounting is not accessible.

SAFETY TONGUE INTERLOCKS

IDEM's range of tongue switches in 316 stainless steel feature industry standard mounting, so upgrading from plastic versions is simple.



MK1-SS



- Mirror Polished Finish
- 1 x M20 or 1/2" NPT Conduit
- Replaceable 3-Pole Contact Block
- Rotating Head
- Suitable for Zones 2 and 3



KM-SS



- Mirror Polished Finish
- 1 x M20 or 1/2" NPT Conduit
- Replaceable 4-Pole Contact Block
- Rotating Head
- Suitable for Zones 2 and 3



K-SS



- Rugged Design
- 3 x M20 or 1/2" NPT Conduit
- Replaceable 4-Pole Contact Block
- Rotating Head
- Suitable for Zones 2 and 3

UGB-NET WITH INDUSTRIAL ETHERNET AND IP69K

The UGB-NET-SS-WR is the only networked enabled safety device on the market with IP69K rating. The housing is manufactured using mirror polished 316 stainless steel, closed with double-seal gaskets and the buttons are protected using special silicone covers.

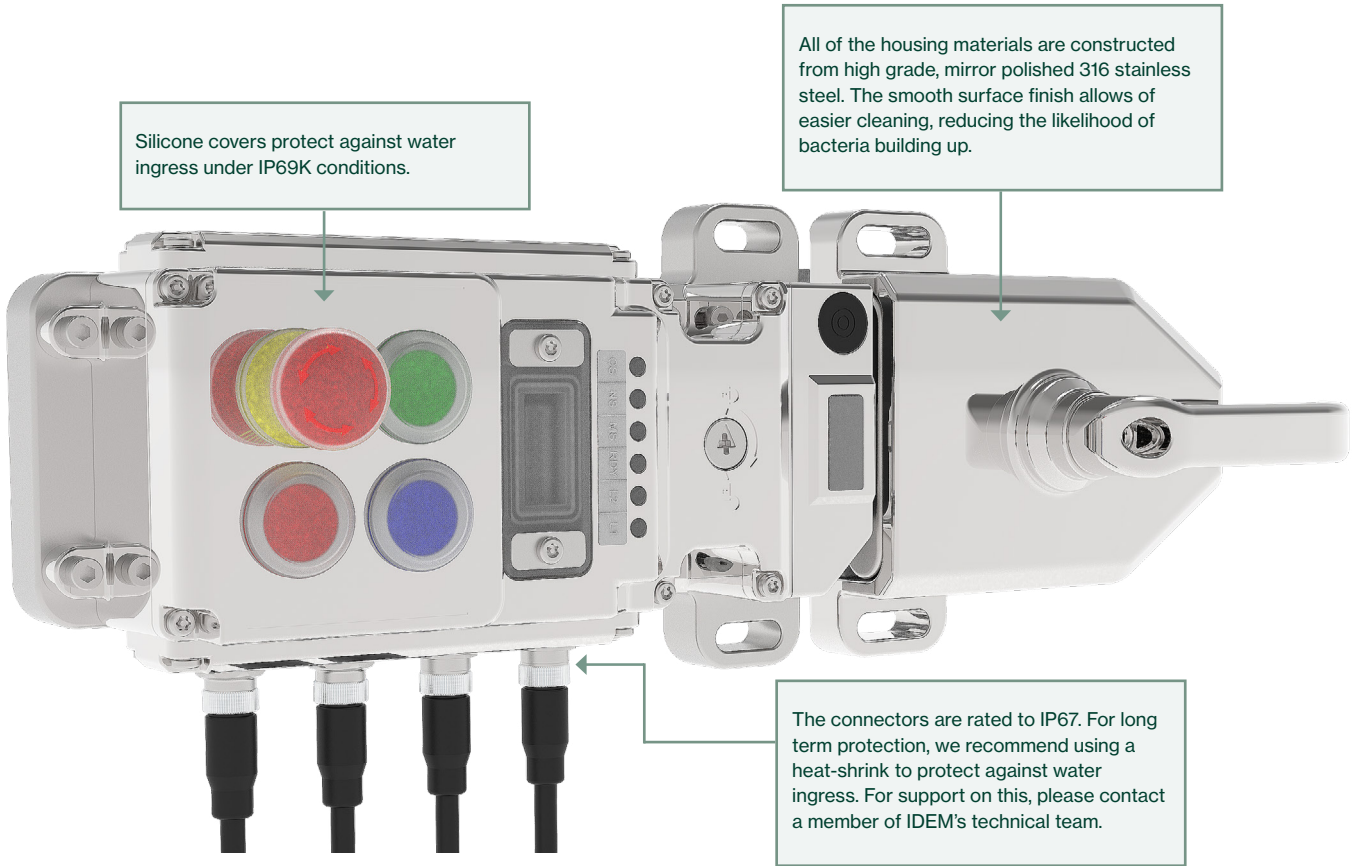



IDEM SAFETY SWITCHES LTD

2 Ormside Close, Hindley Green
Wigan, United Kingdom
WN2 4HR

+44 (0) 1942 257070
sales@idemsafety.com

IDEM SAFETY SWITCHES USA

2574 South Beverly Street
Boise, Suite 100
ID 83709

+1 (510) 445 0751
salesusa@idemsafety.com

WWW.IDEMSAFETY.COM

WWW.IDEMSAFETYUSA.COM



IDEM SAFETY
Making Industry Safer

