

The full product line

Product overview

THE KNOW-HOW FACTORY

THE KNOW-HOW FACTORY

ZIMMER GROUP

COMMITTED TO OUR CUSTOMERS

WE HAVE SUCCEEDED FOR YEARS BY OFFERING OUR CUSTOMERS INNOVATIVE AND INDIVIDUALIZED SOLUTIONS. ZIMMER HAS GROWN CONTINUOUSLY AND TODAY WE HAVE REACHED A NEW MILESTONE: THE ESTABLISHMENT OF THE KNOW-HOW FACTORY. IS THERE A SECRET TO OUR SUCCESS?

Foundation. Excellent products and services have always been the foundation of our company's growth. Zimmer is a source of ingenious solutions and important technical innovations. This is why customers with high expectations for technology frequently find their way to us. When things get tricky, Zimmer Group is in its best form.

Style. We have an interdisciplinary approach to everything we do, resulting in refined process solutions in six technology fields. This applies not just to development but to production. Zimmer Group serves all industries and stands ready to resolve even the most unique and highly individualized problems. Worldwide.

Motivation. Customer orientation is perhaps the most important factor of our success. We are a service provider in the complete sense of the word. With Zimmer Group, our customers have a single, centralized contact for all of their needs. We approach each customer's situation with a high level of competence and a broad range of possible solutions.



TECHNOLOGIES

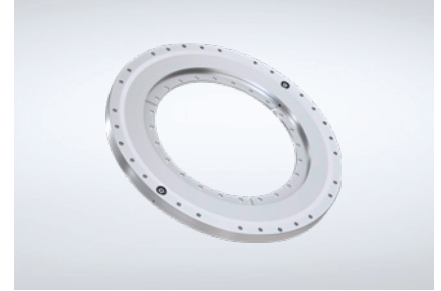
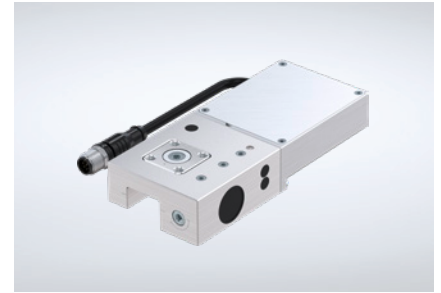
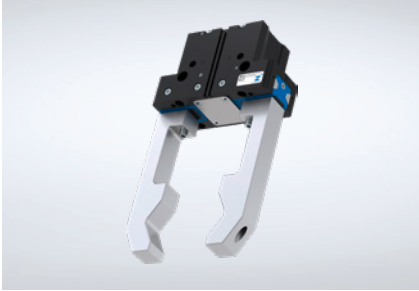

HANDLING TECHNOLOGY

More than 30 years of experience and industry knowledge: our pneumatic, hydraulic and electrical handling components and systems are global leaders.

Components. More than 2,000 standardized grippers, pivot units, robot accessories and much more. We offer a complete selection of technologically superior products that are ready for rapid delivery.

Semi-standard. Our modular approach to design enables custom configurations and high rates of innovation for process automation.

DAMPING TECHNOLOGY

Industrial damping technology and Soft Close products exemplify the innovation and pioneering spirit of the Know-how Factory.

Industrial damping technology. Whether standard or customized solutions, our products stand for the highest cycle rates and maximum energy absorption with minimal space requirements.

Soft Close. Development and production of superior quality pneumatic and fluid dampers. High-volume production ensures rapid delivery.

OEM and direct. Whether they need components, returning mechanisms or complete production lines—we are the trusted partner of many prestigious customers.

LINEAR TECHNOLOGY

We develop linear technology components and systems that are individually adapted to our customers' needs.

Clamping and braking elements. We offer you more than 4000 types for profiled and round rails as well as for a variety of guide systems from all manufacturers. It makes no difference whether you prefer manual, pneumatic, electric or hydraulic drive.

Flexibility. Our clamping and braking elements ensure that movable components such as Z-axes or machining tables maintain a fixed position and that machines and systems come to a stop as quickly as possible in an emergency.

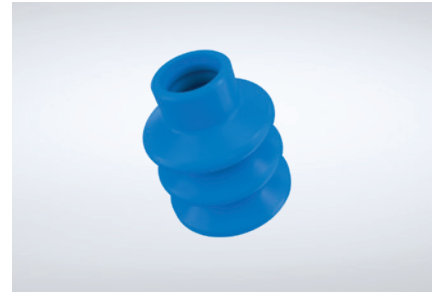
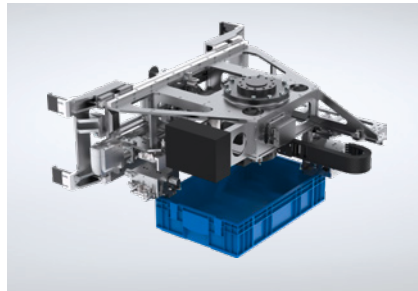
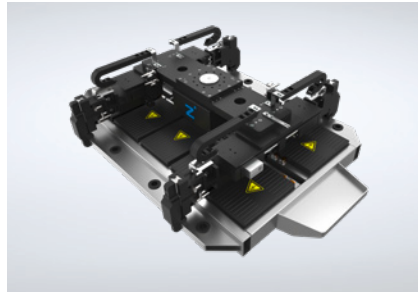
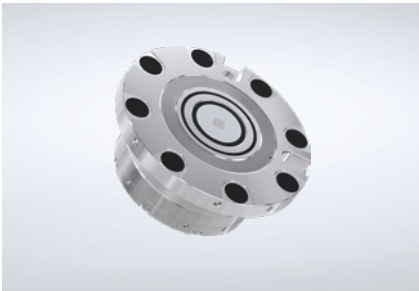

MACHINE TECHNOLOGY

Zimmer Group develops innovative metal, wood and composite material processing tool systems for all industries. Numerous customers choose us as their systems and innovation partner.

Knowledge and experience. Industry knowledge and a decades-long development partnership for exchangeable assemblies, tool interfaces and tool systems predestine us for new challenges around the world.

Components. We deliver numerous standard components from stock and develop innovative, customized systems for OEM and end customers—far beyond the metal and wood processing industries.

Variety. Whether you have machining centers, lathes or flexible production cells, the power tools, holders, assemblies and drilling heads of Zimmer Group are ready for action.

SYSTEM TECHNOLOGY

Zimmer Group is one of world's leading specialists in the development of customized systems solutions.

Customized. A team made up of more than 20 experienced designers and project engineers develop and produce customized solutions for special tasks in close collaboration with end customers and system integrators. It doesn't matter if it is a simple gripper and handling solutions or a complex system solution.

Solutions. These system solutions are used in many industries, from mechanical engineering to the automotive and supplier industries and from the plastics engineering, electronics and consumer goods industries all the way to foundries. The Know-how Factory helps countless companies to thrive competitively by increasing automation efficiency.

PROCESS TECHNOLOGY

Maximum efficiency is essential for systems and components used in process technology. High-level custom solutions are our trademark.

A rich reservoir of experience. Our know-how ranges from the development of materials, processes and tools through product design to production of series products.

Vertical integration. The Zimmer Group pairs these capabilities with flexibility, quality and precision, even when making custom products.

Series production. We manufacture demanding products out of metal (MIM), elastomers and plastics with flexibility and speed.

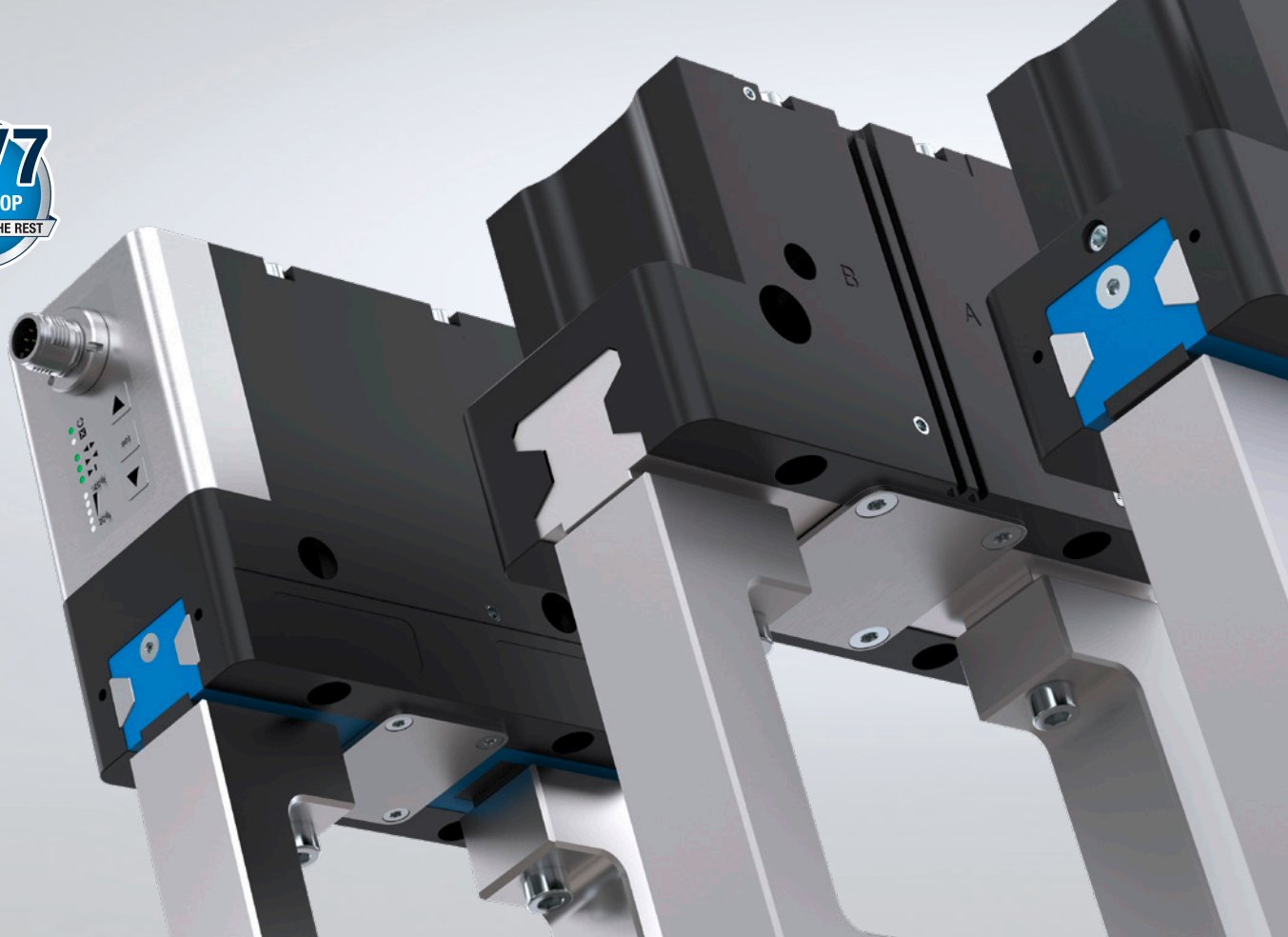

HANDLING TECHNOLOGY

GRIPPER TECHNOLOGY HIGHLIGHTS

UNIVERSALLY APPLICABLE GRIPPER SOLUTIONS

Process-reliable gripping: This can only be achieved with the right gripper to make your robot capable of handling its tasks. Zimmer Group has been developing new and improved grippers over and over again since 1980, helping you to make your production more flexible and efficient. To do this, we consistently focus on the needs of our users,

develop the right gripper solutions for specific applications and markets, and always strive for precision and quality. You can find these decades of experience in all of our grippers, especially in our 5000 Premium series, which gives you a comprehensive worry-free package, including corrosion protection, IP67 and 30 million maintenance-free cycles.

WELL-FOUNDED SELECTION DECISION VIA CLICK

With the Zimmer Group's online Product Finder, you can find the right product for your application quickly and easily. The calculation, selection guide and configurator functions guide you with the required product data from the start to your final decision.



Scan here to go to our Product Finder for grippers

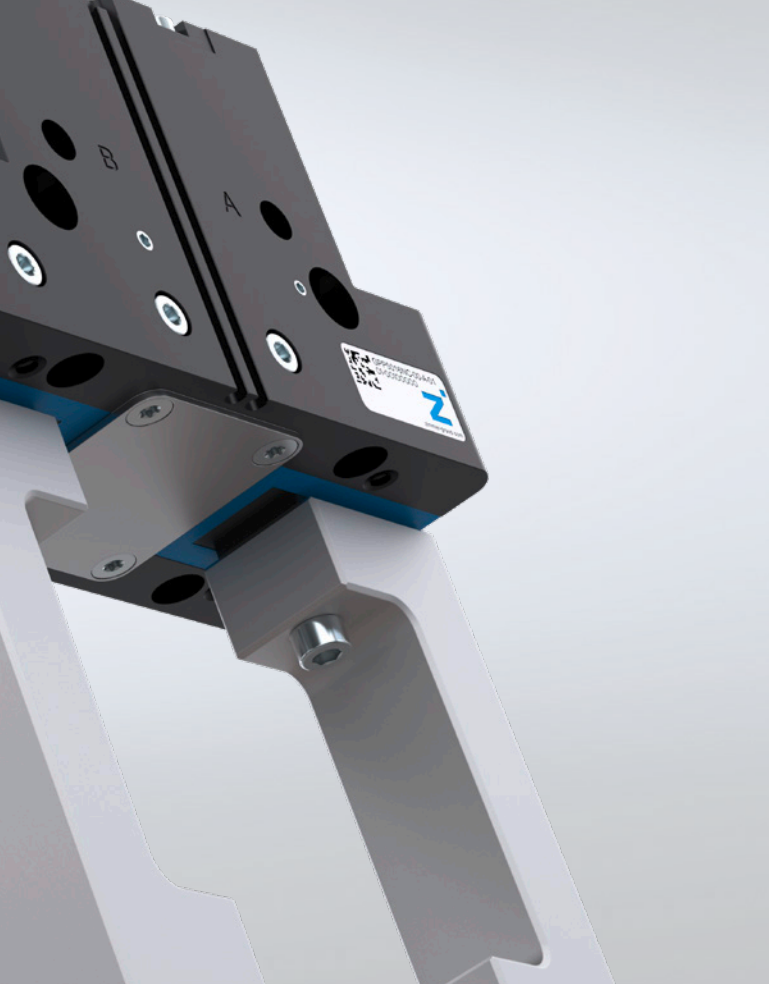

**5000 PRODUCT FAMILY
OUR KNOW-HOW – YOUR ADVANTAGES**

Steel Linear Guide – The superior guidance system concept

The steel / steel guide stands for lasting precision, durability and a long service life—with maintenance intervals of up to 30 million gripping cycles. Benefit from these features and increase the profitability and process reliability of your machine.

Leakproof and corrosion protected – The universal gripper

Suitable for virtually all ambient conditions, with a sealed guide up to IP67 and corrosion protection as standard, you are able to use this gripper universally. As a result, the range of models in your production is reduced, along with a reduction in associated storage and process costs.

Aluminum Linear Guide – The Alternative

Reduced to those aspects which are the most important, the steel / aluminum guide variant offers significantly better performance when compared to a similar gripper with a T-slot travel guide, and is on par with the best principles of toothed guidance systems.

▲
Regardless of whether electric, pneumatic or pneumatically intelligent. One of the most versatile series in our repertoire – grippers from the 5000 product family.

GEP2000 SERIES

By providing the longest stroke in a small installation space, nothing stands in the way of form-fit gripping and moving a wide variety of parts.

MGP800 SERIES

The 2-jaw parallel gripper combines the highest levels of force and torque absorption with maximum flexibility and dynamics.

GEH6000IL SERIES

The 2-jaw parallel gripper combines brushless drive technology with position, speed and force control.

HANDLING TECHNOLOGY

GRIPPERS AT A GLANCE

2-JAW PARALLEL GRIPPER

PNEUMATIC

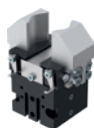

GP
 Stroke per jaw: 3 mm - 13 mm
 Gripping force: 8.4 N - 5250 N
 Weight: 0.033 kg - 1.4 kg
 IP class: 30
 Maintenance free (max.): 10 million cycles

6



MGP800
 Stroke per jaw: 1 mm - 12 mm
 Gripping force: 6 N - 400 N
 Weight: 0.008 kg - 0.46 kg
 IP class: 40
 Maintenance free (max.): 10 million cycles



GP400
 Stroke per jaw: 3 mm - 30 mm
 Gripping force: 85 N - 19275 N
 Weight: 0.08 kg - 18.9 kg
 IP class: 40
 Maintenance free (max.): 10 million cycles

4



GPP5000
 Stroke per jaw: 2.5 mm - 45 mm
 Gripping force: 140N - 26950 N
 Weight: 0.08 kg - 50 kg
 IP class: 64/67
 Maintenance free (max.): 30 million cycles



GP200
 Stroke per jaw: 6 mm - 40 mm
 Gripping force: 160 N - 4500 N
 Weight: 0.33 kg - 8.3 kg
 IP class: 40
 Maintenance free (max.): 10 million cycles



MGH8000
 Stroke per jaw: 10 mm - 100 mm
 Gripping force: 60 N - 910 N
 Weight: 0.35 kg - 7.3 kg
 IP class: 54
 Maintenance free (max.): 10 million cycles



GH6000
 Stroke per jaw: 20 mm - 200 mm
 Gripping force: 120 N - 3400 N
 Weight: 0.3 kg - 22.7 kg
 IP class: 40
 Maintenance free (max.): 10 million cycles



GHK6000
 Stroke per jaw: 20 mm - 200 mm
 Gripping force: 120 N - 3400 N
 Weight: 1.7 kg - 23.8 kg
 IP class: 40
 Maintenance free (max.): 10 million cycles



GH7000
 Stroke per jaw: 65 mm - 100 mm
 Gripping force: 8000 N - 8500 N
 Weight: 31 kg - 36 kg
 IP class: 64
 Maintenance free (max.): 10 million cycles



GPH8000
 Stroke per jaw: 62 mm - 150 mm
 Gripping force: 900 N - 3300 N
 Weight: 5.7 kg - 43 kg
 IP class: 54
 Maintenance free (max.): 5 million cycles

PNEUMATICALLY INTELLIGENT



GPP5000IL
 Stroke per jaw: 3 mm - 25 mm
 Gripping force: 330 N - 8730 N
 Weight: 0.45 kg - 10.4 kg
 IP class: 64
 Maintenance free (max.): 30 million cycles

ELECTRIC

2



GEP2000
 Stroke per jaw: 6 mm - 20 mm
 Gripping force: 40N - 500 N
 Weight: 0.18 kg - 1.3 kg
 IP class: 40/54
 Maintenance free (max.): 10 million cycles



GEP5000
 Stroke per jaw: 6 mm - 10 mm
 Gripping force: 540 N - 1520 N
 Weight: 0.79 kg - 1.66 kg
 IP class: 64
 Maintenance free (max.): 30 million cycles

4



GEH6000IL
 Stroke per jaw: 40 mm - 80 mm
 Gripping force: 180 N - 1800 N
 Weight: 0.7 kg - 2.6 kg
 IP class: 54
 Maintenance free (max.): 5 million cycles



GEH8000
 Stroke per jaw: 60 mm
 Gripping force: 3200 N
 Weight: 9.3 kg
 IP class: 54
 Maintenance free (max.): 10 million cycles

3-JAW CONCENTRIC GRIPPER

PNEUMATIC



GD
 Stroke per jaw: 120° - 180°
 Gripping torque: 0.12 Nm - 9 Nm
 Weight: 0.08 kg - 2 kg
 IP class: 40
 Maintenance free (max.): 10 million cycles

6



MGD800
 Stroke per jaw: 1 mm - 12 mm
 Gripping force: 30 N - 1420 N
 Weight: 0.025 kg - 2 kg
 IP class: 40
 Maintenance free (max.): 10 million cycles



GD300
 Stroke per jaw: 3 mm - 30 mm
 Gripping force: 200 N - 34700 N
 Weight: 0.13 kg - 24 kg
 IP class: 40
 Maintenance free (max.): 10 million cycles

4



GPD5000
 Stroke per jaw: 2.5 mm - 45 mm
 Gripping force: 310N - 72500 N
 Weight: 0.14 kg - 100 kg
 IP class: 64/67
 Maintenance free (max.): 30 million cycles



GD500
 Stroke per jaw: 30 mm - 60 mm
 Gripping force: 1,300 N - 2480 N
 Weight: 7.4 kg - 29 kg
 IP class: 40
 Maintenance free (max.): 10 million cycles

PNEUMATICALLY INTELLIGENT



GPD5000IL	Stroke per jaw:	3 mm - 25 mm
	Gripping force:	740 N - 22850 N
	Weight:	0.75 kg - 18.6 kg
	IP class:	64
	Maintenance free (max.):	30 million cycles

ELECTRIC

4



GED5000	Stroke per jaw:	6 mm - 10 mm
	Gripping force:	980 N - 1520 N
	Weight:	1.09 kg - 2.33 kg
	IP class:	64
	Maintenance free (max.):	30 million cycles

4



GED6000IL	Stroke per jaw:	40 mm
	Gripping force:	800 N - 1700 N
	Weight:	2.8 kg - 4.9 kg
	IP class:	54
	Maintenance free (max.):	5 million cycles

2-JAW ANGULAR GRIPPER

PNEUMATIC



GZ1000	Stroke per jaw:	8° - 10°
	Gripping force:	62 N - 315 N
	Weight:	0.015 kg - 0.125 kg
	IP class:	30
	Maintenance free (max.):	10 million cycles



MGW800	Stroke per jaw:	37.5°
	Gripping force:	5 N - 325 N
	Weight:	0.01 kg - 0.45 kg
	IP class:	30
	Maintenance free (max.):	10 million cycles



GK	Stroke per jaw:	90°
	Gripping force:	70 N - 4250 N
	Weight:	0.1 kg - 4.1 kg
	IP class:	20
	Maintenance free (max.):	10 million cycles



GG4000	Stroke per jaw:	90°
	Gripping force:	430 N - 4000 N
	Weight:	0.25 kg - 4.5 kg
	IP class:	64
	Maintenance free (max.):	10 million cycles



GPW5000	Stroke per jaw:	+15° / -2°
	Gripping force:	1330 N - 14,500 N
	Weight:	0.9 kg - 12.1 kg
	IP class:	64
	Maintenance free (max.):	30 million cycles

2-JAW PARALLEL ROTARY GRIPPER

PNEUMATIC



DGP400	Stroke per jaw:	4 mm
	Gripping force:	115 N - 155 N
	Weight:	0.44 kg - 0.48 kg
	IP class:	40
	Maintenance free (max.):	1.5 million cycles

2-JAW ANGULAR ROTARY GRIPPER

PNEUMATIC



DGK	Stroke per jaw:	90°
	Gripping force:	150 N
	Weight:	0.55 kg
	IP class:	20
	Maintenance free (max.):	1.5 million cycles

INTERNAL GRIPPER

PNEUMATIC



LGS, LG1000, LGG	Full stroke in Ø:	1 mm - 16 mm
	Gripper hole diameter:	4 mm - 135.5 mm
	Weight:	0.031 kg - 2.7 kg
	IP class:	40/54

OUTER O-RING ASSEMBLY GRIPPER

PNEUMATIC



GS	O-ring Ø:	4 mm - 150 mm
	Expanding force:	300 N - 1450 N
	Weight:	0.5 kg - 5.4 kg
	IP class:	30
	Maintenance free (max.):	5 million cycles

NEEDLE GRIPPER

PNEUMATIC



ST	Needle stroke:	0 mm - 2 mm
	Number of needles:	20
	Weight:	0.21 kg - 0.49 kg
	IP class:	30
	Maintenance free (max.):	5 million cycles



SCH	Needle stroke:	0 mm - 6 mm
	Number of needles:	4
	Weight:	0.35 kg - 0.37
	IP class:	40
	Maintenance free (max.):	5 million cycles

MAGNETIC GRIPPER

PNEUMATIC



HM1000	Max. holding force:	27 N - 450 N
	Weight:	0.06 kg - 2.2 kg
	IP class:	30
	Maintenance free (max.):	5 million cycles

Thanks to low particle emissions, they are certified according to international standard DIN EN ISO 14644-1 for clean room classes between 2 and 6.





INFORMATION

The gripper was designed according to DGUV recommendations and has integrated workpiece detection over the entire stroke as well as a mechanical self-locking mechanism – for safe handling even in emergency stop operation.

HANDLING TECHNOLOGY

HRC GRIPPERS AT A GLANCE

ROBUST ALL-AROUND PERFORMER

You do the cognitively challenging work – leave the monotonous and effort-intensive tasks to the robot. Too good to be true? Thanks to collaborative robotics, nowadays human and robot can share the workspace and work closely together without risk. Thus ensuring more precision, flexibility and efficiency.

You can find further HRC components in the MATCH component overview.

[More info about MATCH on page 20](#) 

Cooperation



- ▶ Zones of action
- ▶ Workpiece holder in a secure area
- ▶ Gripper with special HRC geometry
- ▶ Secure holding of the workpiece even if the power supply fails
- ▶ Shared workspaces
- ▶ Coupled work
- ▶ No contact necessary
- ▶ Reduced speed

Collaboration

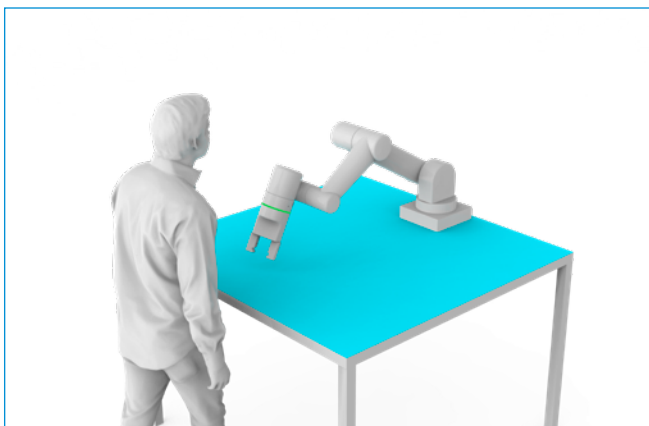

- ▶ Shared workspaces
- ▶ Workpiece holder in an unsecured area
- ▶ Gripper with special HRC geometry and reliable gripping force limiter
- ▶ Gripping force limited to a max. of 140N as per ISO/ TS 15066
- ▶ Secure holding of the workpiece even if the power supply fails
- ▶ Coupled work
- ▶ Contact is necessary
- ▶ Reduced speed

2-JAW PARALLEL GRIPPER

ELECTRIC



HRC-03

Control:
HRC design:
Gripping force in accordance with ISO/TS 15066:
IP class:

IO / IO-Link collaborative

<140 N
40

3-JAW CONCENTRIC GRIPPER

ELECTRIC



HRC-07

Control:
HRC design:
Gripping force in accordance with ISO/TS 15066:
IP class:

I/O link collaborative

<140 N
40

HANDLING TECHNOLOGY

SWIVEL AND ROTARY MODULES

HIGHEST LEVEL OF DIVERSITY AND VARIATION

Thanks to customized and highly flexible units, there are no limits to the wide variety of applications. Whether you need a flat swivel unit, angular pivot unit, rotor cylinder or swivel jaw, this range combines both pneumatic and electric swivel and rotary modules. This makes a nearly universal range of applications possible thanks to various torques and infinitely adjustable swivel angles.

SF-C SERIES

OUR EXPERTISE – YOUR ADVANTAGES

Up to 100% more performance than the benchmark

Superior end position damping lets you pivot more mass in the shortest amount of time, increasing your machine's component output.

Large center bore

Reduce the interference contours in your application by routing your power supply line directly through the middle of the rotary flange.

More than 100% higher radial bearing load than the benchmark

The generously dimensioned bearings stand for robustness and long service life, providing maximum process reliability for your application.



▲
The SF series stands for the highest durability and unique damping characteristics.



MSF SERIES

The pneumatic flat swivel unit with fluid feed-through combines customization and flexibility with minimal set-up time.

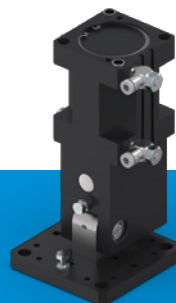

SWM SERIES

The optimized engineering of the pneumatic swivel module ensures space-saving, failure-free continuous operation.

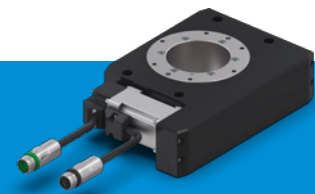

DES SERIES

The individuality and universal design of the electric flat swivel unit ensures application-oriented customization.

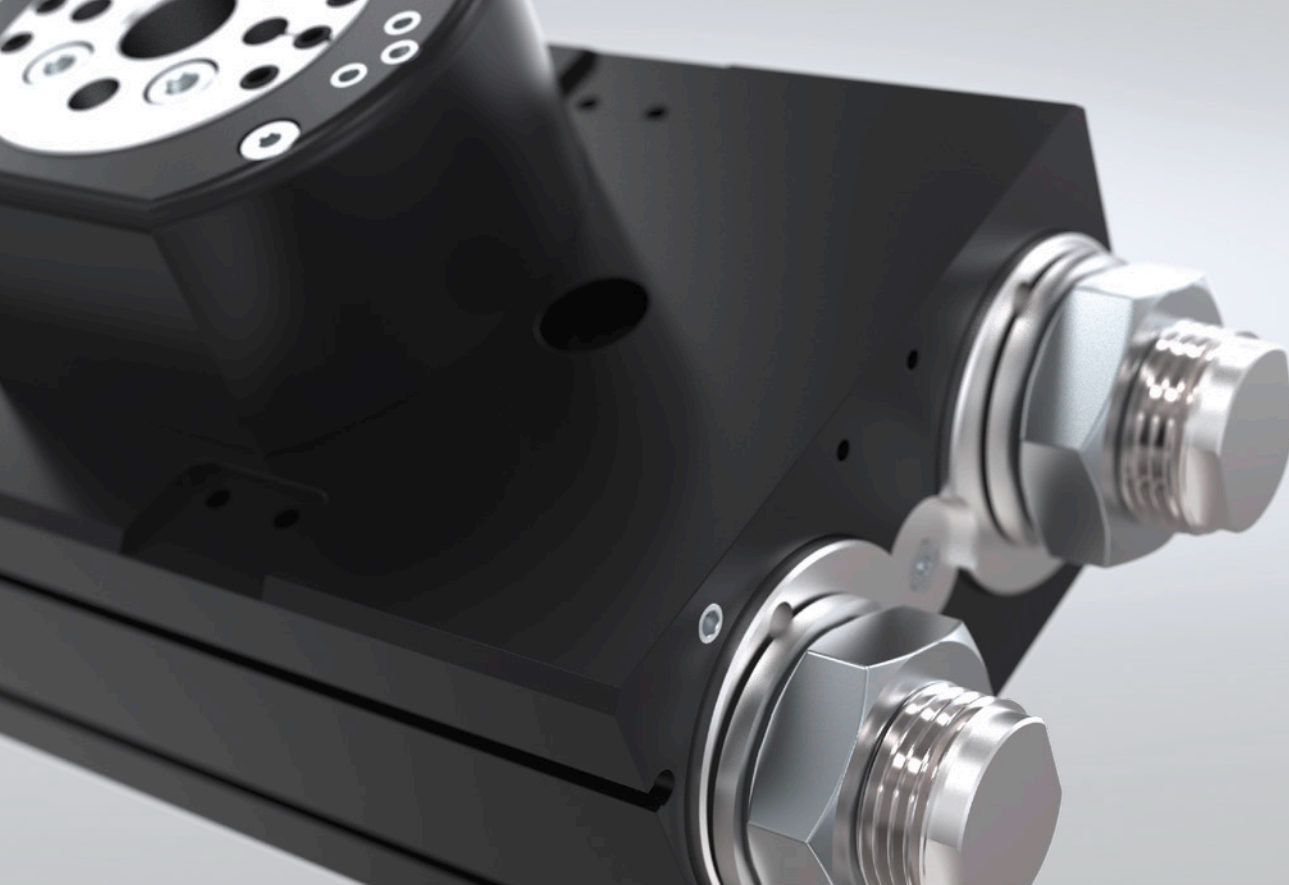

ROTOR CYLINDER

PNEUMATIC



PRN
 Swivel angle: 90°- 270°
 Torque: 0.15 Nm - 247 Nm
 Weight: 0.04 kg - 12.5 kg
 IP class: 54
 Maintenance free (max.): 1.5 million cycles



SH
 Swivel angle: Adjustable up to max
 Torque: 360° 0.59 Nm
 Weight: - 7.2 Nm 0.52 kg -
 IP class: 1.13 kg 54
 Maintenance free (max.): 1.5 million cycles

FLAT SWIVEL UNIT

PNEUMATIC



MSF
 Swivel angle: 90°- 180°
 Torque: 0.3 Nm - 1.2 Nm
 Weight: 0.17 kg - 0.46 kg
 IP class: 41
 Maintenance free (max.): 10 million cycles



SF-C
 Swivel angle: 0°- 180°
 Torque: 1.5 Nm - 130 Nm
 Weight: 0.6 kg - 41.1 kg
 IP class: 64
 Maintenance free (max.): 10 million cycles

ROTARY MODULE

ELECTRIC

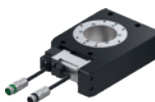

DES
 Swivel angle: Unlimited
 Torque: 9 Nm - 50 Nm
 Weight: 3.8 kg - 15.9 kg
 IP class: 54
 Maintenance free (max.): 5 million maintenance-free revolutions

ANGULAR PIVOT UNIT

PNEUMATIC



SWM1000
 Swivel angle: 90°
 Torque: 7 Nm - 150 Nm
 Weight: 0.65 kg - 5.8 kg
 IP class: 30
 Maintenance free (max.): 10 million cycles



Size
 Swivel angle: 180°
 Torque: 1.5 Nm - 120 Nm
 Weight: 1.2 kg - 48.2 kg
 IP class: 64
 Maintenance free (max.): 10 million cycles

SWIVEL JAWS

PNEUMATIC



SB
 Swivel angle: 90°- 180°
 Torque: 0.1 Nm - 1.6 Nm
 Weight: 0.3 kg - 2.2 kg
 IP class: 54
 Maintenance free (max.): 10 million cycles



SBZ
 Swivel angle: 90°- 180°
 Torque: 1.2 Nm - 57 Nm
 Weight: 0.45 kg - 28 kg
 IP class: 54
 Maintenance free (max.): 10 million cycles

HANDLING TECHNOLOGY

OTHER SERIES AT A GLANCE

ADDITIONAL MODULES FOR SPECIAL APPLICATIONS

Increase your flexibility and expand your options with additional modules for special applications. Increase the length of the gripper arm with a linear module by placing an axis in front of the gripper, or allow the gripper to rotate in all

directions with a ball joint. In plastics processing, separate the product and sprue with cutting tongs or use a separator to stop, dampen and hold workpiece carriers at a specific position.

LINEAR MODULES

PNEUMATIC



SHX, LI, LS, LSX, HZ

Stroke:	15 mm - 300 mm
Force:	40 N - 950 N
Weight:	0.15 kg - 7.2 kg
IP class:	40 - 54
Maintenance free (max.):	10 million cycles

SEPARATOR

PNEUMATIC



VEG, VE

Stroke per plunger:	10 mm - 60 mm
Extending force:	40 N - 220 N
Retracting force:	30 N - 170 N
IP class:	40
Maintenance-free up to:	10 million cycles

CUTTING TONGS

PNEUMATIC



ZK1000, ZK

Stroke per jaw:	2.1° - 9°
Closing torque:	14 Nm - 400 Nm
Max. screw diameter:	11 mm
IP class:	30
Maintenance-free up to:	5 million cycles

BALL JOINTS

PNEUMATIC



KG

Swivel angle:	30°
Max. radial torques:	18 Nm - 124 Nm
Max. axial torques:	7500 N - 70000 N



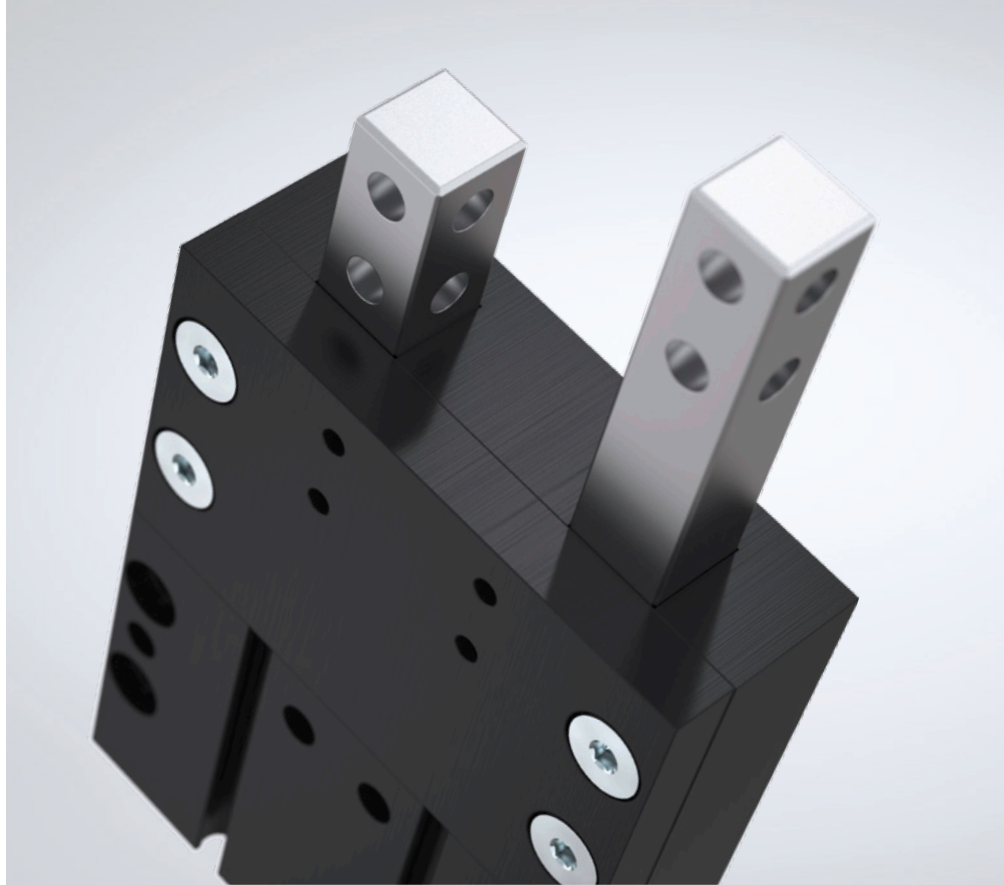
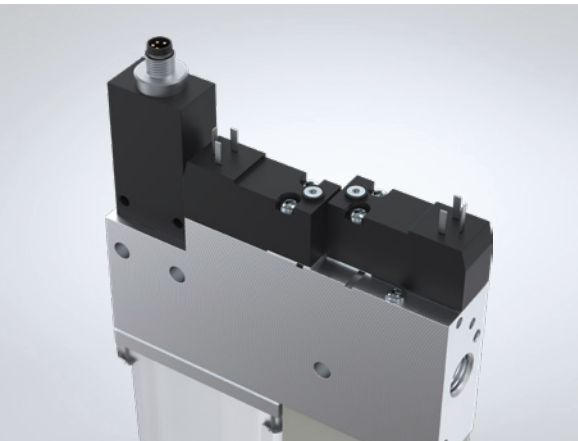

HANDLING TECHNOLOGY

VACUUM COMPONENTS

GENTLE HANDLING IN THE MODULAR CONSTRUCTION SYSTEM

Vacuum grippers ensure the gentlest handling of workpieces: The vacuum is used for suction, to lift and place workpieces at a new position – without having to clasp them. You can customize your own vacuum gripper system from the following components:

Suction grippers are available in various materials for a wide range of requirements. With adapters you can link the suction grippers to any customer-specific application. The vacuum is generated either pneumatically or electrically by the vacuum generator. Compensation modules compensate for height differences or uneven surfaces.

VACUUM COMPONENTS



Suction cup



Adapter



Vacuum generator



Compensation module

HANDLING TECHNOLOGY

ROBOTICS

ROBOT TECHNOLOGY IS ON THE RISE

Robotics is becoming increasingly significant: Robots support people by taking care of monotonous and often repetitive workflows, do activities that require greater-than-human strength, and perform tasks that have particularly stringent requirements for precision or are associated with high risks.

Using robots can increase productivity and product quality, which leads to lower production costs and more effective processes. In recent years in particular, the field of robotics has diversified into various subdisciplines.



Scan here to go to our
Product Finder for robots

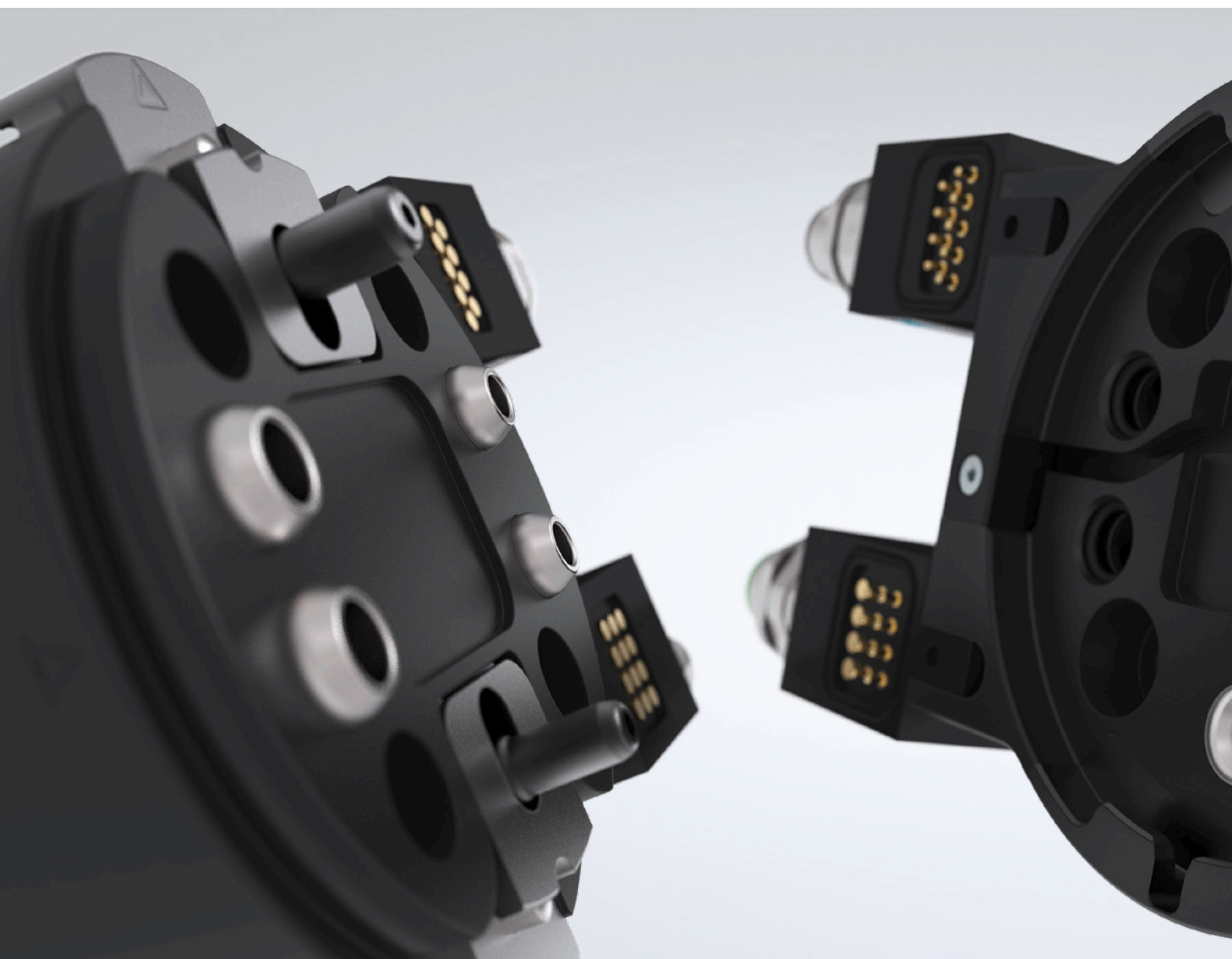

Conventional industrial robots

Real powerhouses that can process even the heaviest workpieces quickly and precisely. Ever since developing the world's first series gripper in 1980, the Zimmer Group has been setting the standards for end-of-arm tools for conventional robotics.

[Robot accessories on page 18](#)



Lightweight robots

Lightweight robots that can also be operated without a safety fence or alongside people. They are more cost-effective, can be installed and commissioned more quickly and easily, so they are also suitable for users just getting into robotics.

[More info about MATCH on page 20](#)



Human-robot collaboration

The latest trend in robotics: People and robots share a workspace and work together as a team. The Zimmer Group has been making grippers for collaborative robots since 2015 and currently has the world's largest portfolio of these helpers.

[Our HRC gripper on page 11](#)

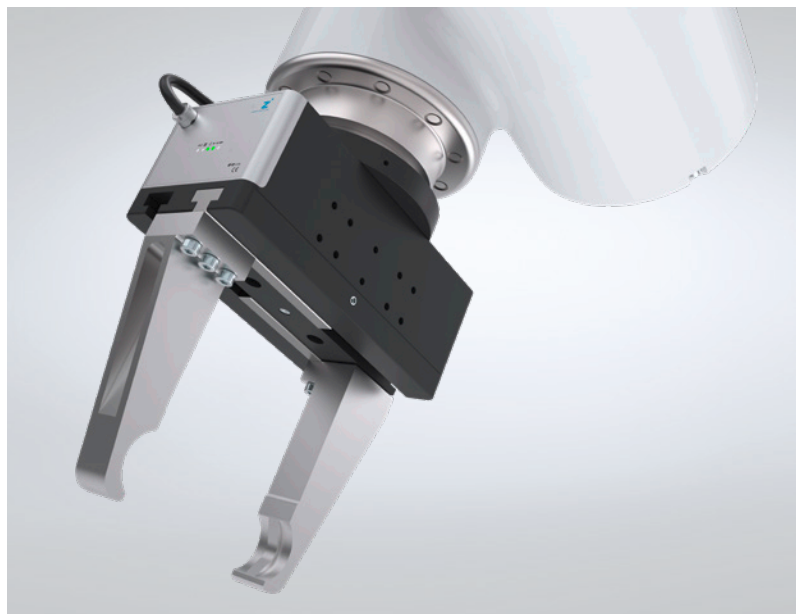

HANDLING TECHNOLOGY

ROBOT ACCESSORIES

FLEXIBLE, STANDARDIZED AND SAFE

You need the right tools to reach the full application potential – that's why we provide everything from an axis compensation module to an angle flange for various components to make your robot application more efficient and productive.

Design height reduces the load capacity of your robot. That's why our components are extremely flat so they can be combined with each other without additional adapter plates.

FWR SERIES OUR KNOW-HOW – YOUR ADVANTAGES

Automated tool change without external activation

When used with the storage station, the changer is actuated mechanically during retraction. As a result, no additional power supply is required for the change operation.

Manual tool change

The sizes FWR40 and FWR50 can be opened with just one hand. If this is not desired, you can lock the actuation manually.

Optional media transmission

With the energy elements of the WER1000 and WER2000 series, you can transmit a variety of media with standard connections.

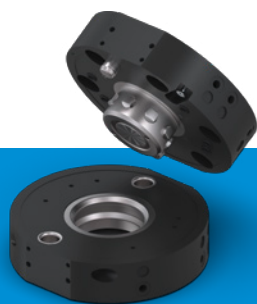

WWR SERIES

Minimum torque load thanks to the flat design of the pneumatic tool changer.



XYR SERIES

Designed for axis compensation movements in the X and Y direction, the axis compensation module ensures ideal compensation for position deviations.

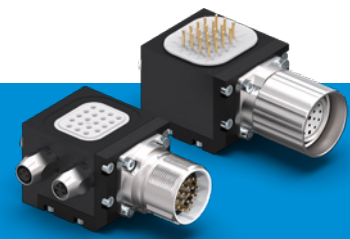

ENERGY ELEMENTS

Essential for transferring various types of media. For manual, pneumatic and automatic tool changers.

HANDLING TECHNOLOGY

ROBOT ACCESSORIES AT A GLANCE

EXCHANGE

MANUAL

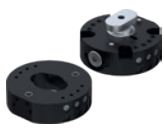

HWR2000

Connection flange: TK 31.5 - TK 50
 Recommended handling weight: 5 kg - 20 kg
 Pneumatic energy transfer: 4 - 8-fold
 Electrical energy transfer: Optional via energy element

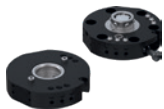

HWR

Connection flange: TK 63 - TK 80
 Recommended handling weight: 50 kg
 Pneumatic energy transfer: 6-fold
 Electrical energy transfer: Optional via energy element

PNEUMATIC



WWR1000

Connection flange: TK 160 - TK 200
 Recommended handling weight: 500 kg - 1,000 kg
 Pneumatic energy transfer: Optional via energy element
 Electrical energy transfer: Optional via energy element



WWR

Connection flange: TK 40 - TK 160
 Recommended handling weight: 20 kg - 300 kg
 Pneumatic energy transfer: 4 - 10-fold
 Electrical energy transfer: Optional via energy element

AUTOMATIC



FWR

Connection flange: TK 40 - TK 80
 Recommended handling weight: 13 kg - 29 kg
 Pneumatic energy transfer: 4-fold
 Electrical energy transfer: Optional via energy element

COMPENSATE

PNEUMATIC



FGR

Connection flange: TK 40 - TK 50
 Recommended handling weight: 10 kg - 20 kg
 Deflection in X/Y: 2 mm - 4 mm
 Centered holding force: 120 N - 250 N



XYR1000

Connection flange: TK 40 - TK 200
 Deflection in X/Y: 3 mm - 12.5 mm
 Centered holding force: 150 N - 3000 N



ZR1000

Connection flange: TK 40 - TK 200
 Deflection in Z: 8 mm - 20 mm
 Holding force: 250 N - 11500 N



ARP

Connection flange: TK 40 - TK 160
 Recommended handling weight: 3 kg - 60 kg
 Deflection in X/Y: 2 mm
 Deflection in Z: 2 mm
 Centered holding force: 170 N - 3000 N

PROTECT

PNEUMATIC



CSR

Connection flange: TK 50 - TK 160
 Z-axis deflection: 12.5 mm - 28 mm
 Horizontal deflection +/-: 9° - 12.5°



CRR

Connection flange: TK 40 - TK 200
 Z-axis deflection: 8 mm - 42 mm
 Horizontal deflection +/-: 13° - 14°

TRANSMIT

MANUAL



DVR1000

Connection flange: TK125
 Continuous torque: 4 Nm
 Pneumatic energy transfer: 8-fold
 Electrical energy transfer: 4-pin + PE



DVR

Connection flange: TK40 - TK160
 Continuous torque: 1 Nm - 4 Nm
 Pneumatic energy transfer: 4 - 8-fold
 Electrical energy transfer: 4 - 12-pin

ENERGY ELEMENTS

ELECTRIC / COMMUNICATION



WER

For transmitting signal and load currents.



HYDRAULIC



WER

For transmitting hydraulics, pneumatics and vacuum

ANGLE FLANGE

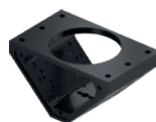

WFR

Suitable for more than 40 different robot types and combinable with many different grippers for the machine load.

HANDLING TECHNOLOGY

END-OF-ARM ECOSYSTEM



APPLICATIONS AS VARIED AS THE SYSTEM

Whether mobile and collaborative robotics or fully automated applications: Just one flexible system gives the user access to a nearly unlimited range of uses from production and installation to warehouse logistics, shipping and even laboratory automation. Typical tasks for the system include

pick-and-place, order picking, packaging and palletizing, checking and testing. Various mechanical and vacuum grippers can be selected corresponding to the workpiece and handling task. If the requirements change, the system can be quickly and easily adapted.



Standardization of the robot interface

One robot module – the entire spectrum of compatible end effectors. Regardless of whether cobots, lightweight robots or conventional robots.



Easy installation – Plug & Work

Simplified machine communication thanks to the required communication parameters.



Flexible – large selection of end effectors

Direct control and monitoring of robot functions using a software solution.



Complex robot applications

Can perform various tasks on a workpiece via automated end effector replacement.

For all common robot manufacturers

The right robot module for your application

A large selection of various end effectors

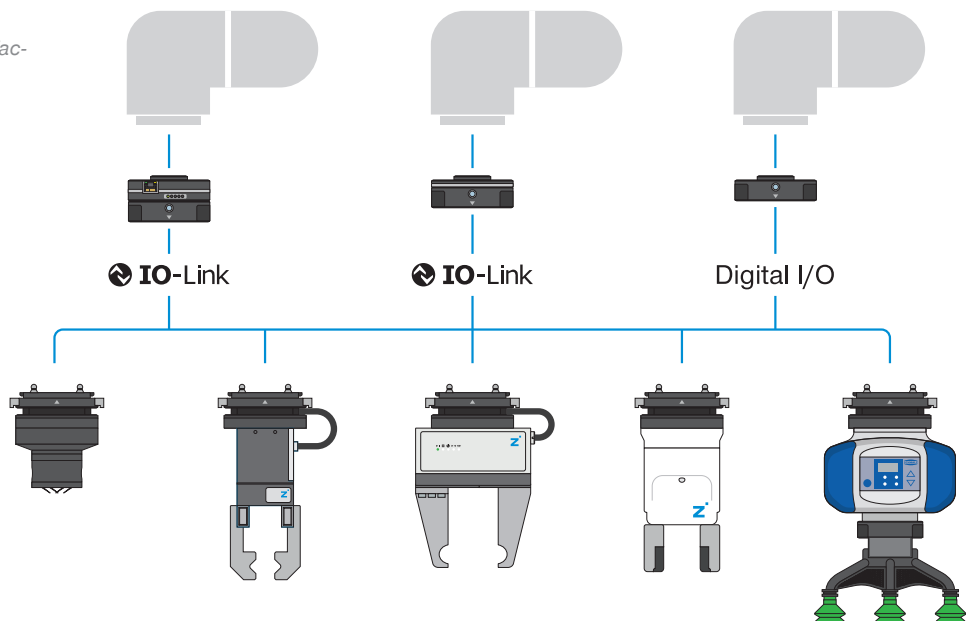

can handle an almost unlimited number of workpieces.



EXAMPLE OF AUTOMATED MACHINE EQUIPPING FOR LOW QUANTITIES

With a comprehensive ECOSYSTEM of grippers from normal- to large-stroke as well as suction and vacuum components that are adapted flexibly to the respective workpiece, machine loading can handle low quantities due to fast adaptation times and simplified servicing

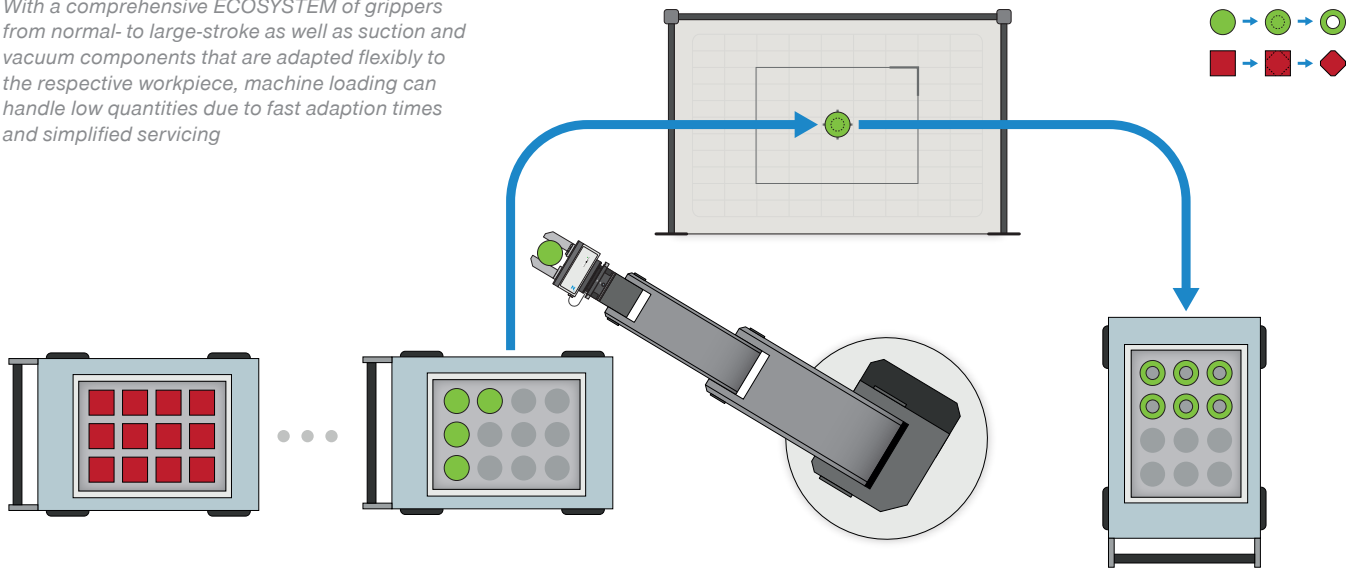

EXAMPLE OF COLLABORATIVE WORKPIECE ASSEMBLY FOR LOW QUANTITIES

Effective support thanks to a collaborative robot and an end effector – entirely without any programming knowledge required. Combining the simplest set-up option and the fastest adaptation times.

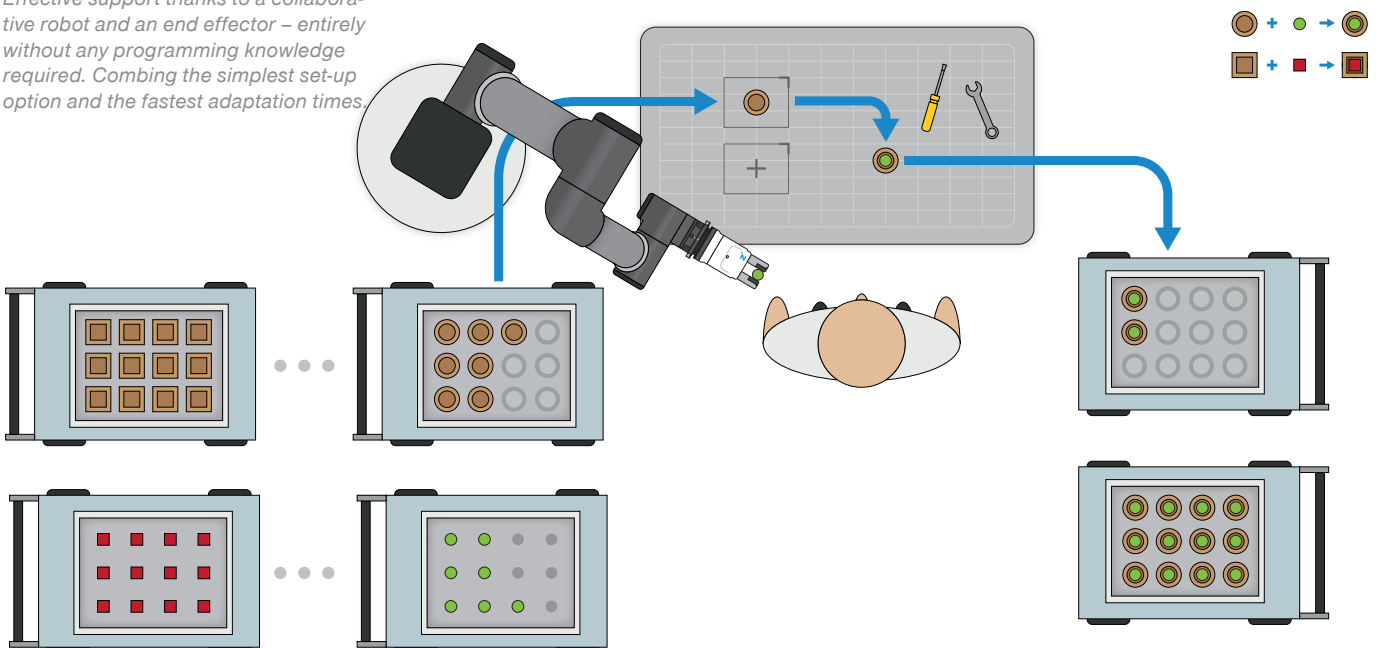

HANDLING TECHNOLOGY

THE SERIES AT A GLANCE

ROBOT MODULE

IO-LINK



LWR50F-xx-04/05

Suitable for robot type: ISO TK 50, ABB, Yaskawa
 Max. handling weight: 25 kg
 Repeat accuracy in X, Y, Z: 0.05 mm
 IP class: 40

DIGITAL I/O



LWR50F-xx-01/02

Suitable for robot type: Universal Robots, Techman, Hanwha, Mitsubishi, Fanuc, ABB, Fruitcore, Yaskawa, ELITE Robot, KUKA
 Max. handling weight: 25 kg
 Repeat accuracy in X, Y, Z: 0.05 mm
 IP class: 40

RS485



LWR50F-xx-03

Suitable for robot type: Universal Robots
 Max. handling weight: 25 kg
 Repeat accuracy in X, Y, Z: 0.05 mm
 IP class: 40

2-JAW PARALLEL GRIPPER

PNEUMATICALLY INTELLIGENT



GPP5000IL

Suitable for robot module: LWR50F-xx-03/04/05
 Nominal gripping force: 330 N - 1080 N
 IP class: 40

ELECTRIC



GEP2000

Suitable for robot module: LWR50F-xx-01/02/03/04/05
 Nominal gripping force: 200 N
 IP class: 40



GEH6000IL

Suitable for robot module: LWR50F-xx-03/04/05
 Nominal gripping force: 180 N - 1000 N
 IP class: 40



HRC-03

Suitable for robot module: LWR50F-xx-01/02/03/04/05
 Nominal gripping force: 190 N
 IP class: 40



HRC-02

Suitable for robot module: LWR50F-xx-03/04/05
 Drive type: electric
 Nominal gripping force: 165 N
 IP class: 40

3-JAW CONCENTRIC GRIPPERS

PNEUMATICALLY INTELLIGENT



GPD5000IL

Suitable for robot module: LWR50F-xx-03/04/05
 Nominal gripping force: 740 N - 2370 N
 IP class: 40

NEEDLE GRIPPER

PNEUMATIC



ST

Suitable for robot module: LWR50F-xx-01/02/03/04/05
 Max. needle stroke: 1.5 mm
 Number of needles: 20
 IP class: 30

MAGNETIC GRIPPER

PNEUMATIC



HM1000

Suitable for robot module: LWR50F-xx-01/02/03/04/05
 Max. adhesive force: 27 N
 IP class: 40

ACCESSORIES



ALWR1

Standardized storage station for all MATCH end effectors



Scan here to go to our Product Finder for robots

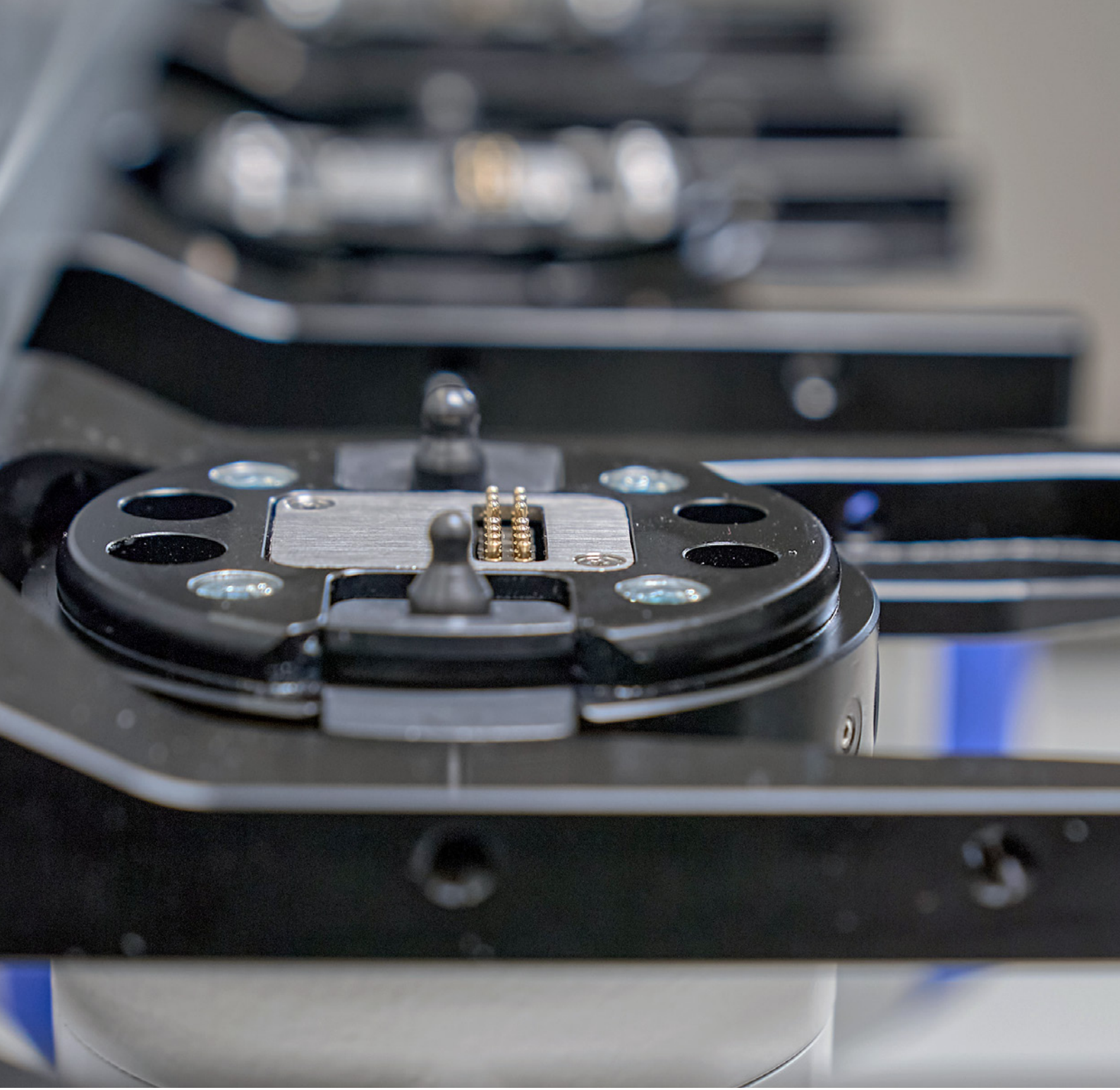

HANDLING TECHNOLOGY

COMMUNICATION

SMART GRIPPER, SMART CONNECTION

Robot programming made easy: with ready-to-connect communication modules from the Zimmer Group that are placed in the robot controller and connected to the control system via cable or wirelessly, depending on the module. The ComfortApp, coordinated to the robot manufacturer, makes it possible to actuate and operate the gripper conveniently and directly using the respective robot control pendant – easy to set up with all necessary commands for a smooth automatic mode.

With Zimmer Group programming tools, robot applications can be put into operation quickly, easily and without extensive programming knowledge. Zimmer Group also provides downloadable function blocks for all the most common manufacturers for direct programming in the PLC.

The standardized, IO-Link Wireless communication model ensures interference-free and reliable communication, entirely without external cabling. All IO-Link gripper components can be used and their standardized interface makes them compatible with many kinds of control systems. The voltage supply is provided by the connecting line as usual. Energy can be buffered as needed, while the information is exchanged between the control system and the gripper directly and without delay.

The Smart Communication Module – The intelligent gateway between the gripper and the robot control system.



Scan here to go to our Product Finder for robots

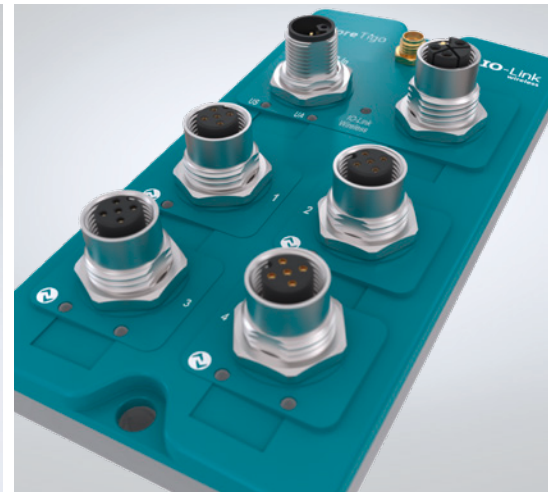



SCM

The intelligent gateway between grippers and the robot control system translates IO-Link on digital inputs and outputs.



- Includes:
- + Smart Communication Module
 - + guideZ, expertZ monitorZ software bundle



SCM + COMFORT

Easy actuation and operation of the gripper directly with the respective robot control pendant thanks to the ComfortApp.



- Includes:
- + Smart Communication Module
 - + guideZ, expertZ monitorZ software bundle
 - + ComfortApp



SCM + COMFORT (READY-TO-CONNECT)

Easy integration of the SCM placed in the robot module via a ready-to-connect cable and controller.



- Includes:
- + Smart Communication Module
 - + guideZ, expertZ monitorZ software bundle
 - + ComfortApp
 - + Robot-specific connection elements



COMPLETE SOLUTION CONVENTIONAL

Conventional complete solution from the gripper to the SCM, including intuitive operating software, to the tool.



- Includes:
- + Smart Communication Module
 - + guideZ, expertZ monitorZ software bundle
 - + ComfortApp
 - + Robot-specific connection elements
 - + Conventional gripper



COMPLETE SOLUTION MATCH

Complete solution with standardized MATCH robot interface. Including SCM, operating software and tool.



- Includes:
- + Smart Communication Module
 - + guideZ, expertZ monitorZ software bundle
 - + ComfortApp
 - + Robot-specific connection elements
 - + MATCH robot module
 - + MATCH gripper



Conventional complete solution or MATCH complete solution

Whether conventional or with the MATCH End-of-Arm Ecosystem - Zimmer Group ready-to-connect communication modules give you complete solution customized to your needs. Interference-free communication from gripper to machine is ensured thanks to the direct integration of a digital infrastructure.

DIGITAL SERVICES

digitalz

THE FUTURE OF AUTOMATION AND MECHANICAL AND SYSTEMS ENGINEERING

Everyone is talking about digital transformation in production: This refers to digital technologies, which are intended to lower production costs, improve quality, increase flexibility and ultimately increase revenue. Fast and flexible solutions are becoming increasingly important in automation. Mechan-

ical and systems engineering is increasingly driven by software innovation. Here, web-based services help implement production reliability, productivity and cost reduction in a Smart Factory and enable them to be planned.

ZIMMER GROUP AS A PARTNER FOR DIGITAL TRANSFORMATION

Zimmer Group recognized the digital transformation trend early on and already offers a wide portfolio of mechatronic components and digital services. The digitalZ digital software modules expand the primary functionalities of mechatronic components and systems from the Zimmer

Group and targets various phases in the product lifecycle of your system. From project engineering and development to operation and even service calls, these components support the function of your system, making it more ergonomic, flexible, productive and reliable.



THE DIGITAL SERVICES OF ZIMMER GROUP

digitalZ helps you support quality, productivity, efficiency and value creation and gives you the ability to make complex processes manageable and map transparency in control and maintenance.

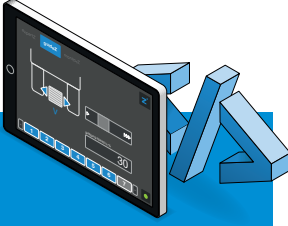

controlZ

- ▶ Platform-independent for all leading robot manufacturers
- ▶ Fast and easy programming
- ▶ Minimization of programming errors
- ▶ Programming and configuration can be carried out even by personnel without comprehensive programming knowledge

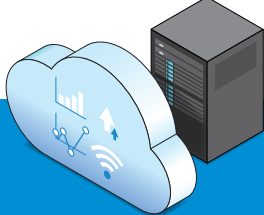

cloudZ

- ▶ Provision of status process parameters
- ▶ Easier integration of components
- ▶ Basis for Condition Monitoring / Predictive Maintenance
- ▶ High level of flexibility and scalability
- ▶ Access from anywhere

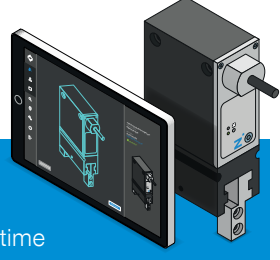

virtualZ

- ▶ Reduction of commissioning time by up to 80%
- ▶ Higher production availability
- ▶ Shorter delivery times, higher quality
- ▶ Safe and efficient qualification of operating and service personnel
- ▶ Flexibility in the selection of simulation platform

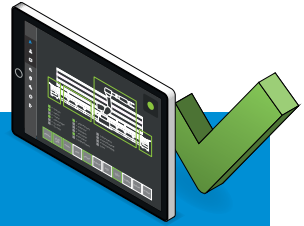

visualZ

- ▶ Fast and easy interaction in the application environment
- ▶ Display of process parameters relevant to the application
- ▶ Increase in efficiency
- ▶ Minimization of input errors



supportZ

- ▶ Pre-sales support
- ▶ After-sales support with on-site service over the entire lifecycle
- ▶ Online support for commissioning and optimization
- ▶ Product finders / product configurators
- ▶ Spare parts service
- ▶ Extensive training programs

DAMPING TECHNOLOGY

INDUSTRIAL SHOCK ABSORBERS

FROM 100 TO 0 WITH A DAMPER

State-of-the-art damper technology: PowerStop is the hydraulic industrial shock absorber created by the Zimmer Group that slows down the kinetic energy to zero. Due to its optimal capacity, PowerStop achieves maximum energy absorption in the smallest installation spaces: with unique spiral groove technology – low-vibration and without sacrificing its precision.

The new modular construction set available at www.zimmer-group.com makes it possible to combine highly versatile application-specific variants from four series, each with a stroke variant, speed range, protection and head. Everything comes from standard elements, delivering the shortest time to availability and ideal pricing.

POWERSTOP PRODUCT FAMILY OUR KNOW-HOW – YOUR ADVANTAGES

Low-vibration and precise braking

Due to the constantly narrowing spiral groove.

Long service life

Less wear thanks to the hydrostatic piston guide.

Corrosion protection

From using stainless steel.

THROTTLE MECHANISM – CONVENTIONAL SOLUTION

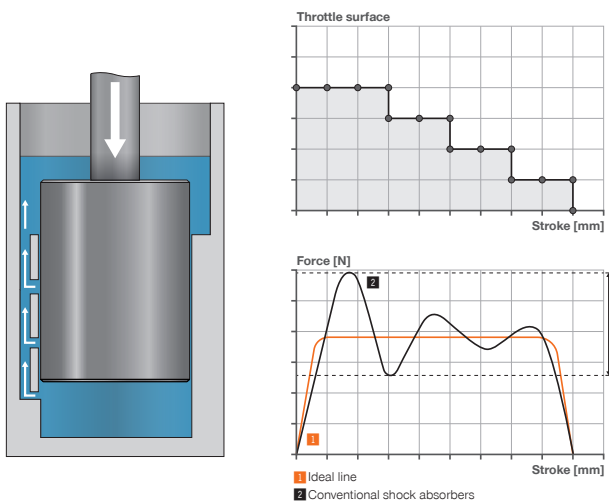

SPIRAL GROOVE TECHNOLOGY – THE HIGH-END SOLUTION OF THE ZIMMER GROUP

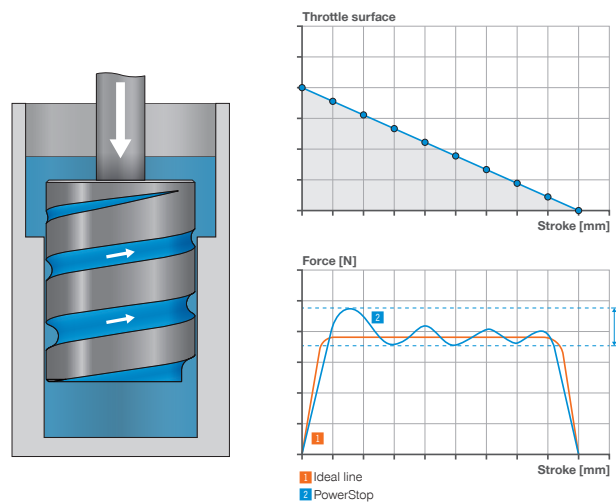

OIL RESERVE

The shock absorbers of the High Energy series are filled with oil accordingly so that the volume compensation spring is under pre-load. Automatic readjustment of the spring compensates for oil loss, which results in a long service life.

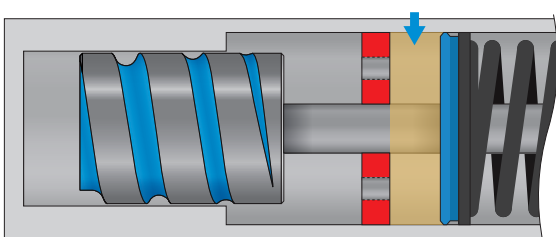

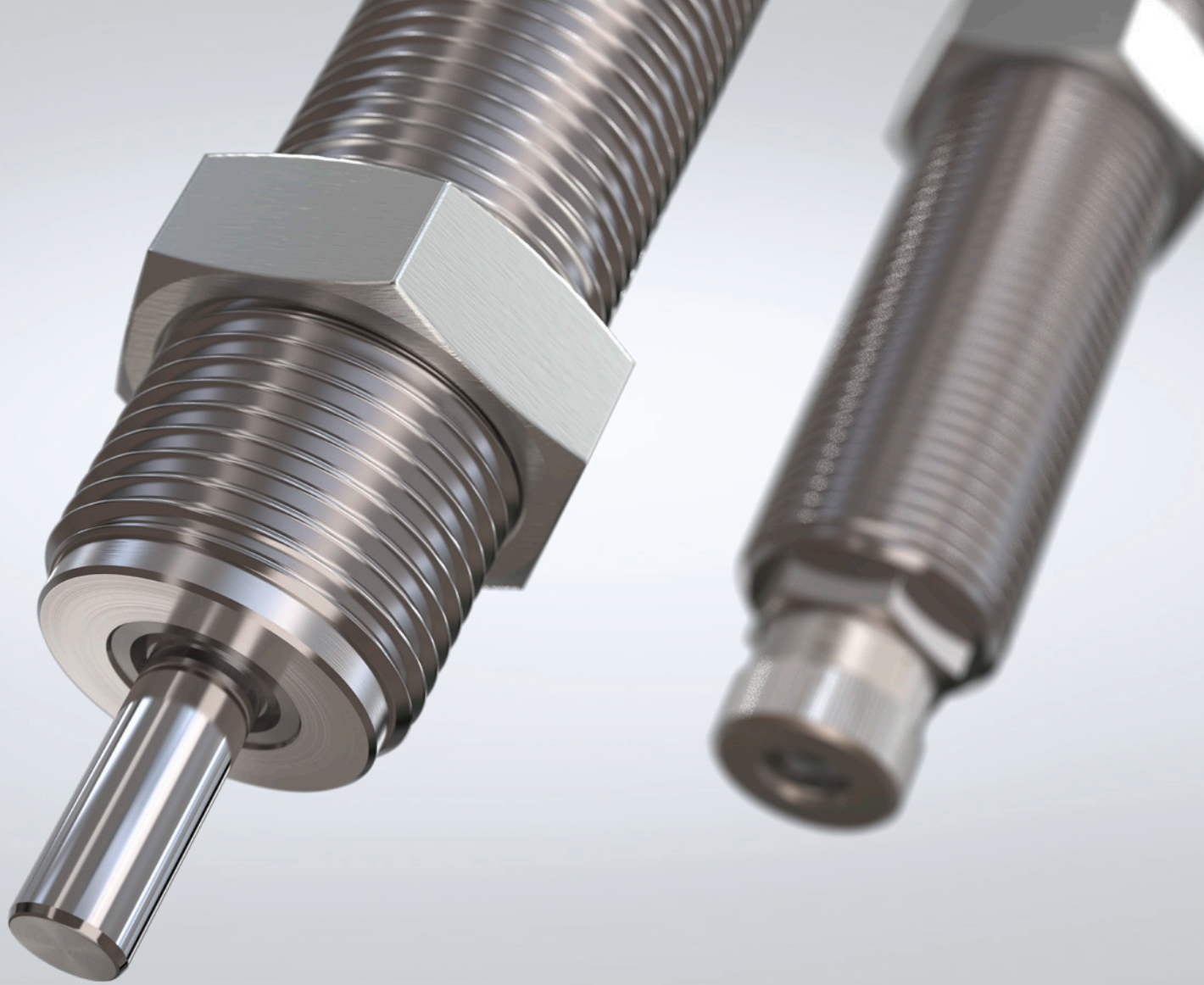

PowerStop – Highest quality for the most extreme requirements and loads.



STANDARD ENERGY

The number one among standard dampers. Efficient damping at common energy absorption levels. This makes the Standard Energy series the winner in price/performance value.



HIGH ENERGY

Featuring maximum numbers of cycles, the high-end damper meets the highest requirements for extreme energy absorption.

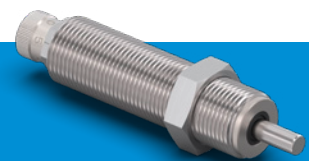

ADJUSTABLE ENERGY

The adjustable damper for all kinds of strokes combines sensitive energy absorption with power reduction and gentle damping.

DAMPING TECHNOLOGY

PROFILE DAMPER

THE EFFICIENT ENERGY CONSUMER

The BasicStop profile damper comes into play when pin-point accuracy is not required for braking. Because of its specially developed profile and high-performance TPC plastic, BasicStop can also brake masses under extreme conditions, achieving a high damping percentage at the same time. It can also be used at any speed and recycled 100% thanks to its thermoplastic properties.

BASICSTOP PRODUCT FAMILY OUR EXPERTISE – YOUR ADVANTAGES

TPC high-performance plastic

Exhibits high durability and resistance to media. No swelling, embrittlement or decomposition of the material, as is the case with rubber.

High efficiency

High damping percentage and high energy absorption in the smallest space.

Reliable return behavior

The robust material exhibits hardly any setting behavior.

DAMPING VS. SUSPENSION

Conventional rubber buffers only have a very small damping percentage and are more of a spring than a damper. Using these buffers hardly removes any kinetic energy from the system, which in turn can cause damage to the system. This is where the brand of BasicStop profile dampers are setting new standards for material damping with their high damping percentage.

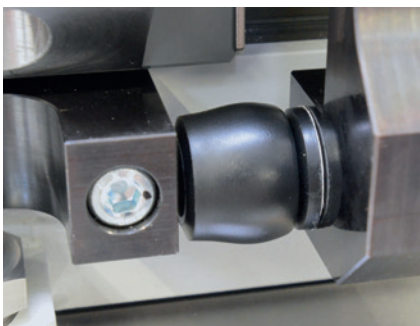
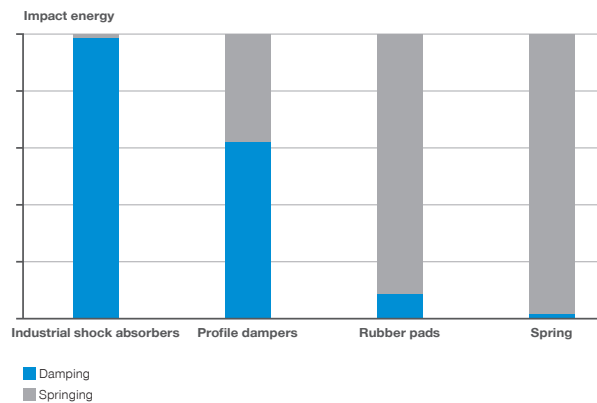

Emergency stop protection in the traveling axis of a spindle tailstock

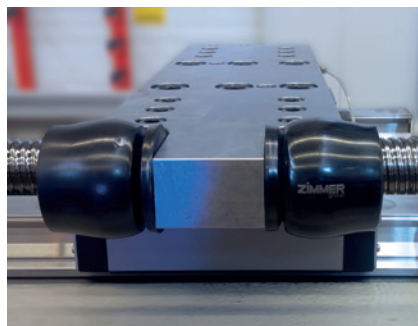

End position damping in the linear axes of production modules



Machine door damping in a machining center

DAMPING TECHNOLOGY

THE SERIES AT A GLANCE

INDUSTRIAL SHOCK ABSORBER

POWERSTOP



MINI ENERGY

Size: M4 - M6
 Max. energy absorption: 0.8 J - 1.8 J
 Min. impact velocity: 0.1 m/s - 1.8 m/s
 Max. impact velocity: 2 m/s
 Max. stroke: 4 mm - 5 mm



STANDARD ENERGY

Size: M8 - M36
 Max. energy absorption: 1.5 J - 185 J
 Min. impact velocity: 0.1 m/s - 3 m/s
 Max. impact velocity: 1.2 m/s - 5 m/s
 Max. stroke: 6 mm - 30 mm



HIGH ENERGY

Size: M8 - M36
 Max. energy absorption: 4 J - 280 J
 Min. impact velocity: 0.1 m/s - 3 m/s
 Max. impact velocity: 1.2 m/s - 5 m/s
 Max. stroke: 6 mm - 50 mm



ADJUSTABLE ENERGY

Size: M8 - M36
 Max. energy absorption: 4 J - 400 J
 Min. impact velocity: 0.1 m/s
 Max. impact velocity: 5 m/s
 Max. stroke: 6 mm - 50 mm

PROFILE DAMPER

BASICSTOP



AXIAL STANDARD

Height: 7 mm - 109 mm
 Max. stroke: 3 mm - 56 mm
 Max. energy absorption: 0.3 J - 2014 J
 Max. damping percentage: 75%
 Design: Axial



AXIAL ADVANCED

Height: 53 mm - 252 mm
 Max. stroke: 40 mm - 198 mm
 Max. energy absorption: 450 J - 12725 J
 Max. damping percentage: 65%
 Design: Axial



RADIAL STANDARD

Height: 23 mm - 88 mm
 Max. stroke: 15 mm - 60 mm
 Max. energy absorption: 36 J - 8700 J
 Max. damping percentage: 60%
 Design: Radial

A special treatment process is what gives the profile damper its unique properties.

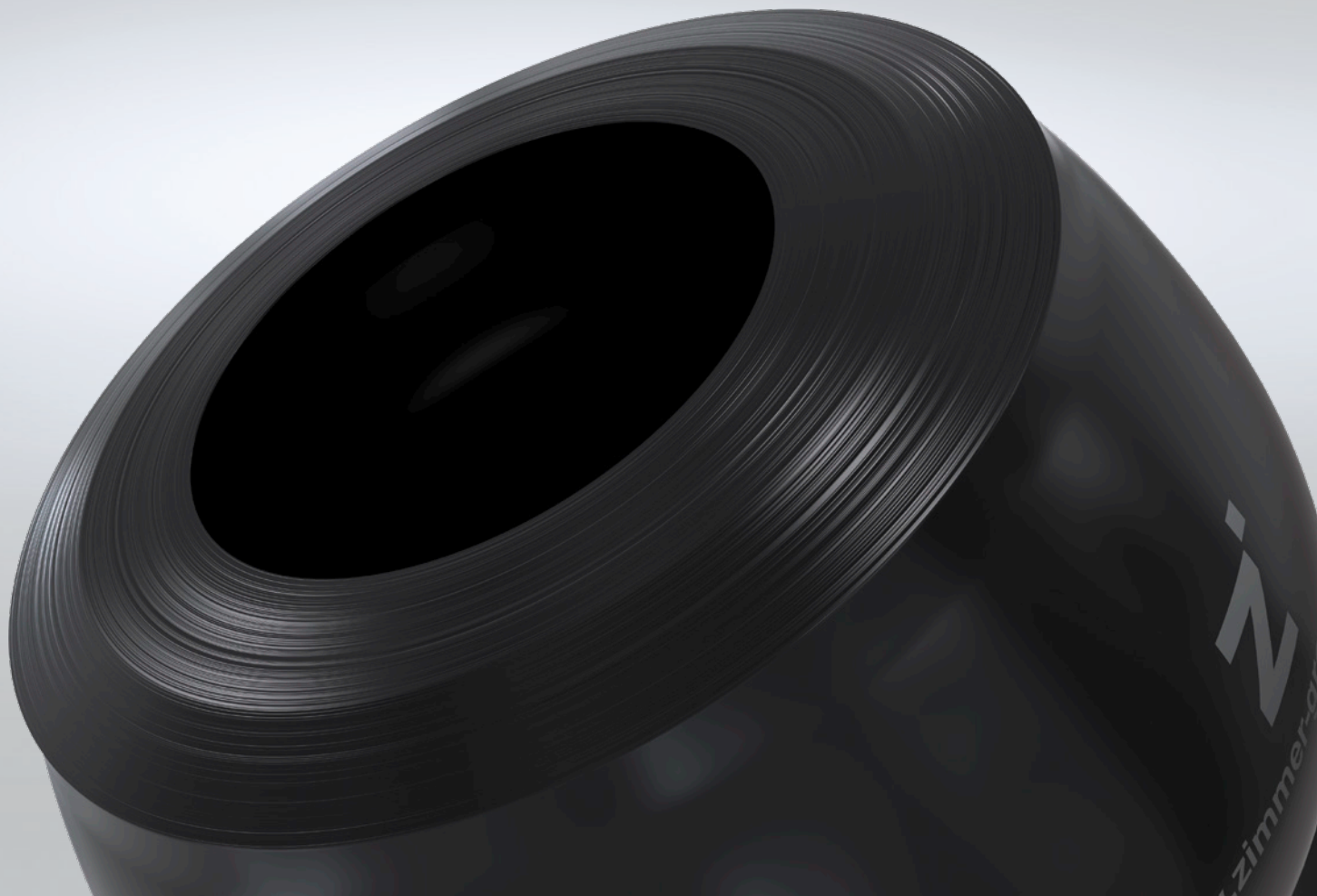

DAMPING TECHNOLOGY

SOFT CLOSE

SMOOTH AND QUIET

Drawers, cabinet doors, lids and even large glass sliding doors and toilet seats close smoothly and quietly because they are equipped with a soft close system. Zimmer GmbH Dämpfungssysteme is one of the leading development partners and suppliers for the furniture industry when it comes to damping systems and retraction mechanisms.

Soft close is a damping technology that uses a spring and a damping that automatically slows down the closing process and ensures a comfortable feel when opening and closing doors and drawers.

COMPREHENSIVE PRODUCT RANGE OUR KNOW-HOW – YOUR ADVANTAGES

Easy to close

Usually a light touch is all you need to close a drawer or door.

Easy on the ears and the material

Soft damping ensures quiet closing and low furniture wear.

Easy to retrofit

Drawers, doors and lids can also be retrofitted with this damping technology at a later time.



PNEUMATIC DAMPERS

Long service life due to integrated return and the resulting friction energy.



HYDRAULIC DAMPER

The viscosity of the oil and the variation in the cross-section of the channels provides a high degree of safety and load capacity.

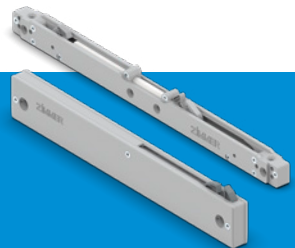

SELF-CLOSING DEVICE

Automatic self-closing devices ensure soft closing inwards, outwards or for dual action.

OPERATING PRINCIPLE

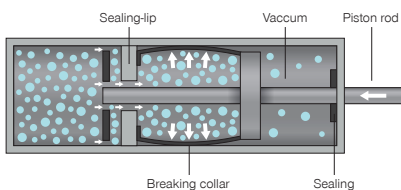

Pneumatic damper

1. In a hollow cylinder, there is a piston that can move back and forth. When closing, the collar brake presses against the cylinder. This generates the friction energy necessary for damping.
2. Oil leakage is not possible.

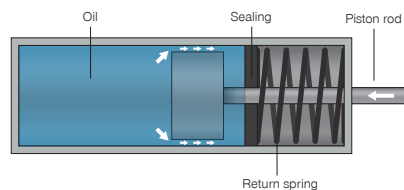

Hydraulic damper

1. In a housing filled with oil, there is a piston that can move back and forth. The viscosity of the oil and the variation in the cross-section of the channels results in the frictional force necessary for damping.
2. High energy absorption for the smallest space.

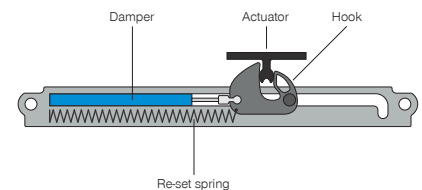

Self-closing unit

1. An automatic self-closing device is attached to the chest of a drawer, for example; an actuator is attached directly to the drawer.
2. The actuator engages with the locking lever and the closing spring retracts the drawer, which is gently braked by the damper at the same time.

DRAWER DAMPING

Dampers and self-closing devices should provide the optimal compromise between force and size: discreet and space-saving, but still robust enough to brake even at high loads.



SLIDING DOOR DAMPING

Even heavy sliding doors can be easily opened with the right dampers. This enhances barrier-free accessibility and easy use and enables children and those with restricted mobility to open and close the door easily.

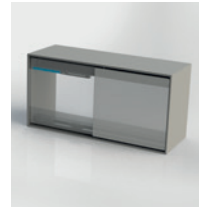

LID DAMPER

Lid dampers can also be used to brake a high mass at short distances so that even kitchen top cabinets, for example, can be easily opened and closed without risking your fingers.



HINGE DAMPING

Say goodbye to rattling doors. With Zimmer Group hinge damping, doors can be closed smoothly and quietly. The damping force can be customized to the door weight to some extent.

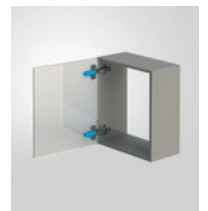

Zimmer GmbH Dämpfungssysteme is one of the leading development partners and suppliers for the furniture industry and a strong system partner when it comes to damping systems and soft-closing mechanisms.



LINEAR TECHNOLOGY

CLAMPING AND BRAKING ELEMENTS

QUALITY AND RELIABILITY

More than 30 years of development and market experience have yielded more than 4,000 products. Zimmer Group offers the most comprehensive and innovative portfolio of products and services reflecting the highest possible quality and reliability. Clamping and braking elements routinely perform critical positioning, holding and braking tasks. They ensure precision during machining processes, boost efficiency with short cycle times and their secure hold maximizes safety.

WEDGE GEAR – TRIED-AND-TESTED FOR OVER 25 YEARS

When it comes to clamping and braking on profiled rail guides and round shaft guides, Zimmer Group is a pioneer with its wedge gear. All pneumatic elements are equipped with a tried-and-tested wedge gear for the highest power transmission and market-leading number of cycles over 5 million (B10d value).

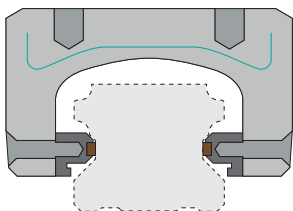

Not pressurized: Closed

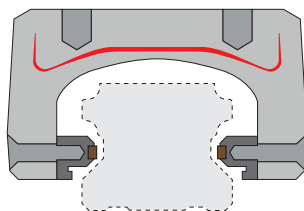

Pressurized: Open

OVER 20,000 COMBINATIONS

You can use our online Product Finder to easily find the right product for your application. It helps you easily search through over 4,000 clamping and braking elements.

DKPS1000 SERIES

OUR EXPERTISE – YOUR ADVANTAGES

High holding force without additional air

Enhanced safety due to securing the rotation axes.

Simple status sensing

Efficient and fast process flow.

Cycle counts that outperform everything else on the market

Leak-free thanks to a proven piston seal.

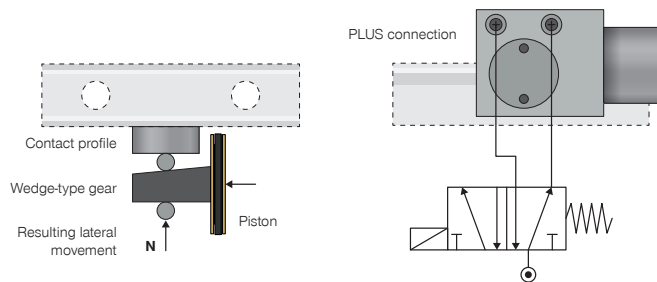

ONE FUNCTIONAL COMPONENT – HIGHEST STIFFNESS

We once again prove our technological expertise with the LBHS series. A hydraulic braking element consisting of a single functional component that does not contain any moving parts and generates all braking and holding forces solely through the inherent tension of the base body. It promises the highest stiffness and quickest response times.



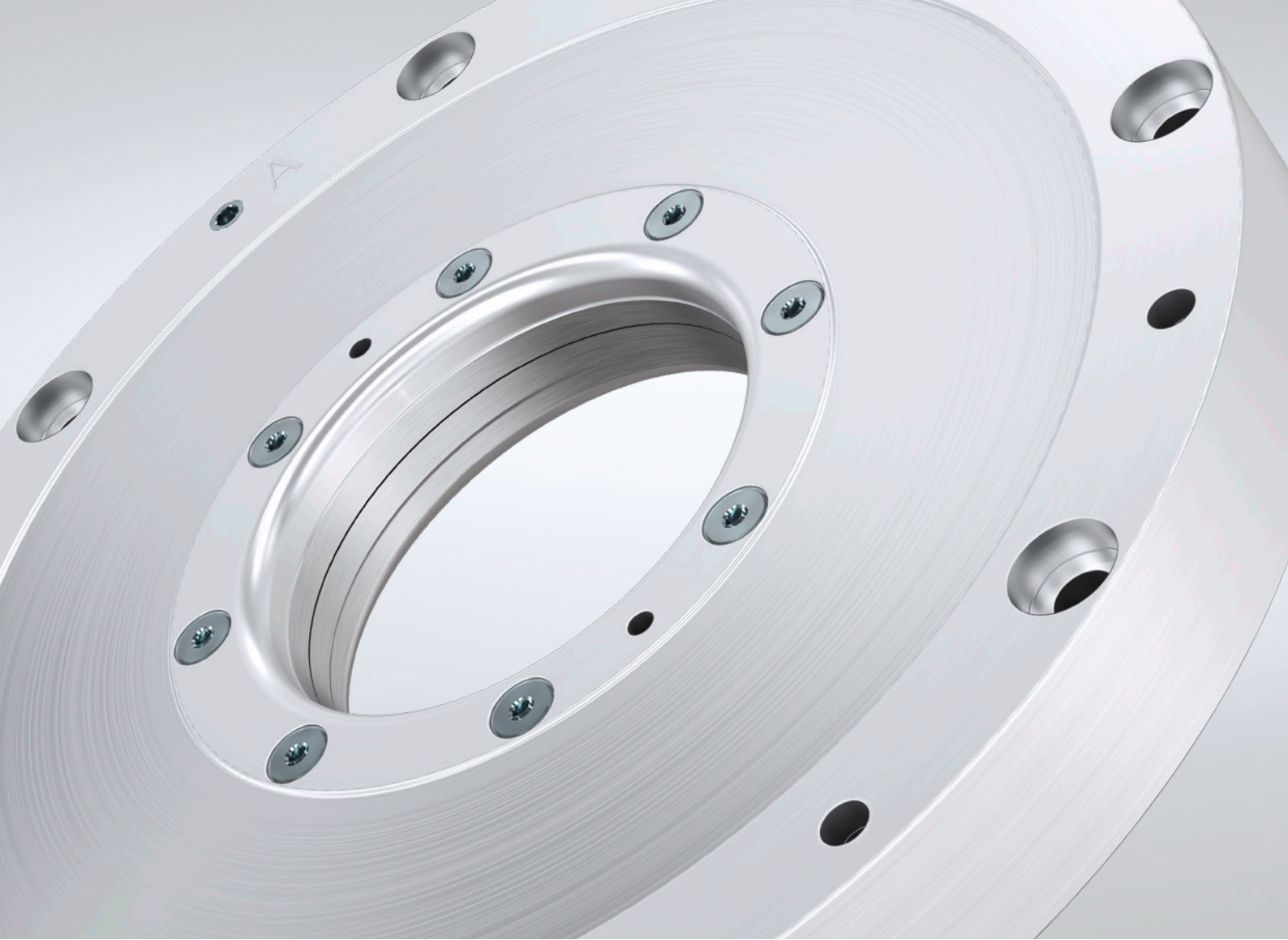

The rotary clamps of the DKPS1000 series provide an impressive non-pressurized holding force, long service life and optional digital sensing.



LKE SERIES

LKE stands for the highest energy efficiency thanks to a flexible cable outlet, integrated electronics and a 24 V power supply.

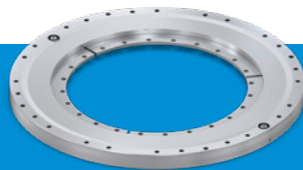

DKHS1000 SERIES

The very durable hydraulic clamping element of the DKHS series features the highest accuracy, number of cycles and fastest response time.



ELECTRO-PNEUMATIC UNIT

The unit provides pneumatic driving force and can actuate several products independently of each other.

LINEAR TECHNOLOGY

CLAMPING AND BRAKING ELEMENTS

FOR PROFILED RAILS

MANUAL



MINIHK

Function: Clamping
Status: N
Max. holding force: 300N
Design: Miniature



HK

Function: Clamping
Status: N
Max. holding force: 2000 N
Design: Standard

PNEUMATIC



MK

Function: Clamping
Status: NO
Max. holding force: 2250 N
Design: Standard



MKS

Function: Clamping
Status: NC
Max. holding force: 3300 N
Design: Standard



MBPS

Function: Clamping, braking
Status: NC
Max. holding force: 4700 N
Design: Standard

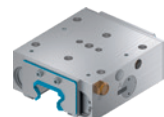

UBPS

Function: Clamping, braking
Status: NC
Max. holding force: 7700 N (9200 N)
Design: Standard

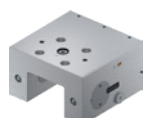

LKP

Function: Clamping
Status: NO
Max. holding force: 4500 N
Design: Narrow



LKPS

Function: Clamping
Status: NC
Max. holding force: 750 N
Design: Narrow



MCP

Function: Clamping
Status: NO
Max. holding force: 550 N
Design: Miniature



MCPS

Function: Clamping
Status: NC
Max. holding force: 700 N
Design: Miniature

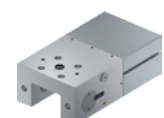

LBPS

Function: Clamping, braking
Status: NC
Max. holding force: 4500 N
Design: Narrow

HYDRAULIC

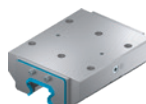

KWH

Function: Clamping
Status: NO
Max. holding force: 46000 N
Design: Standard

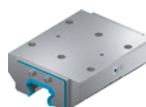

KBH

Function: Clamping, braking
Status: NO
Max. holding force: 46000 N
Design: Standard



LBHS

Function: Clamping, braking
Status: NC
Max. holding force: 15000 N
Design: Standard

ELECTRIC



LKE

Function: Clamping
Status: N
Max. holding force: 1800 N
Design: Standard

FOR ROUND SHAFTS

MANUAL



HKR

Function: Clamping
Status: N
Max. holding force: 2000 N
Design: Standard

PNEUMATIC



MKR

Function: Clamping
Status: NO
Max. holding force: 1850 N
Design: Standard



MKRS

Function: Clamping
Status: NC
Max. holding force: 1650 N
Design: Standard



RBPS

Function: Clamping, braking
Status: NC
Max. holding force: 52000 N
Design: Standard

FOR ROTATION AXES

PNEUMATIC

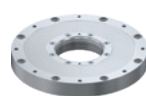

DKPS1000

Function: Clamping
Status: NC
Max. static holding torque: 1150 Nm
Design: Rotary

HYDRAULIC

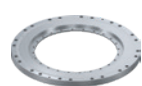

DKHS1000

Function: Clamping
Status: NC
Max. static holding torque: 8000 Nm
Design: Rotary

6 = Certified for clean room class ISO 6.

HOLDING FORCE

The holding force is the maximum force that can be generated in the axial direction. The specified holding forces are tested on every clamping and braking unit before delivery using a slightly lubricated rail (ISO VG 68). Using other oil or lubricating substances can influence the coefficient of friction, which can cause a loss of holding force in individual cases.

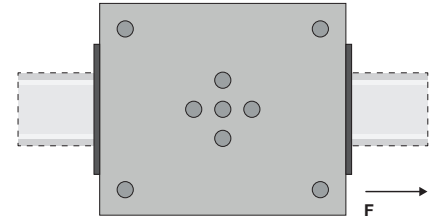

$F = \text{max. holding force}$

STATUSES

N (bistable)

Remains fixed in the current position

NO (normally open)

Open at loss of pressure

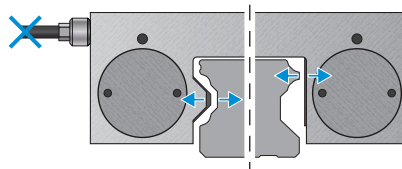

NC (normally closed)

Closed at loss of pressure

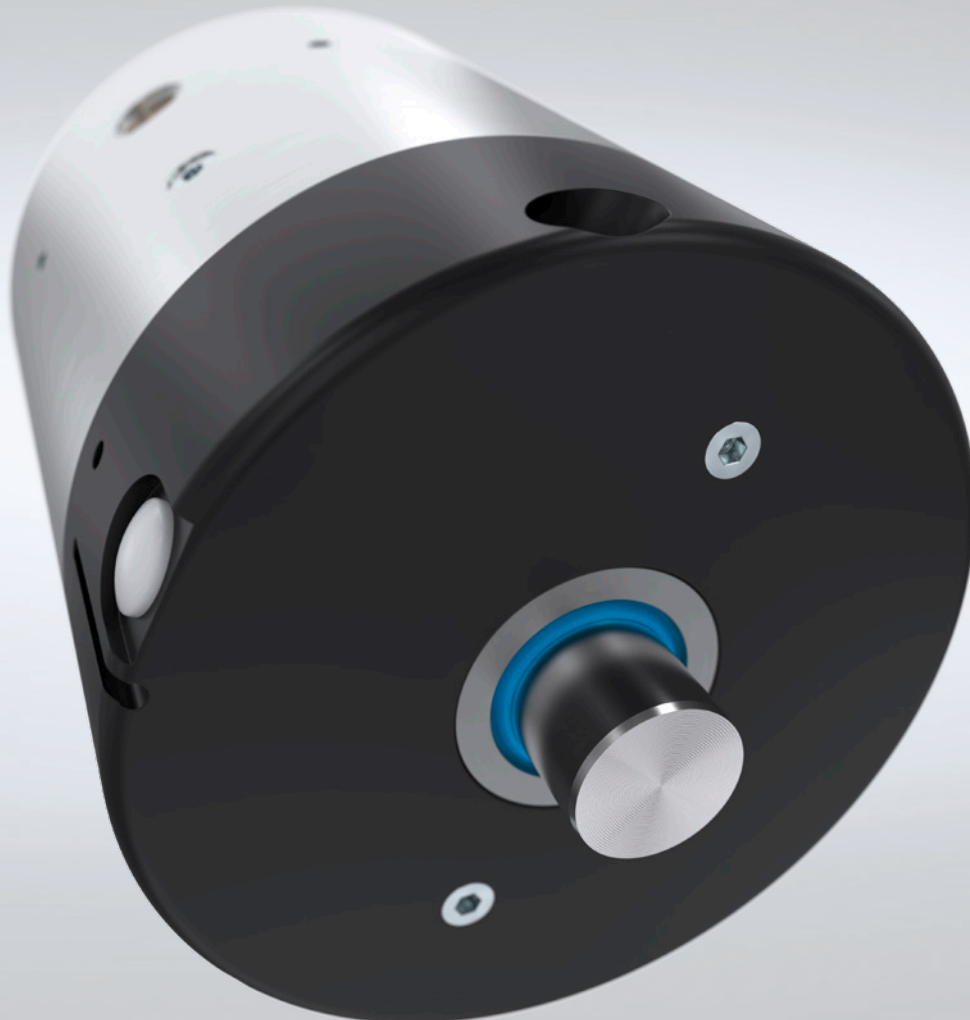
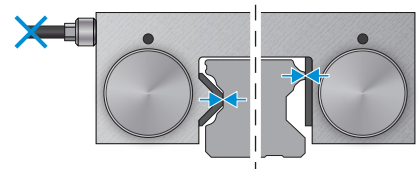

MACHINE TOOLING TECHNOLOGY

MOTOR SPINDLES

MOTOR SPINDLES

As key components in machining centers, tooling machines and end-of-arm applications, our motor spindles guarantee optimal value creation thanks to maximum precision, productivity, availability and long service life. They are critical for the performance of the machine and the quality of machined workpieces. Compact power packages with high power density and high-precision bearings are essential for

achieving high speeds and excellent true-running characteristics. The Zimmer Group product line comprises both air and fluid-cooled motor spindles for wood, aluminum and plastics processing as well as for metal cutting. The spindles stand out for their extremely high reliability, superior power density and a wide range of compatibility.

HF150-003 SERIES

OUR KNOW-HOW – YOUR ADVANTAGES

Maximum performance

The highest performance standards for these motor spindles are met due to the exclusive use of vacuum cast, hand-wound, high-performance motors from German manufacturing.

Maximum workpiece quality

With speeds of up to 26,000 rpm and an optional vector-regulated 14.5 kW motor, these motor spindles are best suited for processing various materials such as wood, plastic, light metal or composites.

Highest productivity meets highest precision

This mechanically integrated motor solution is extremely compact, highly productive and achieves maximum stiffness.



WATER-COOLED

Water cooling and a dimensioned cooling unit ensure highly productive spindles thanks to optimized temperature control.

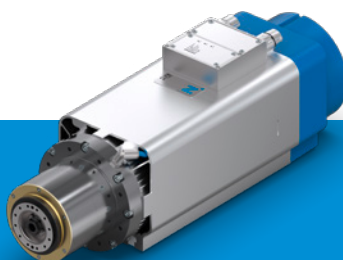

AIR-COOLED

Air inlets and a sufficient air circulation volume are the ideal prerequisites for spindles with a high power density.



ROBOT CHANGE UNITS

The WWS series enables a fully automatic change of motor spindles.

WATER-COOLED**ASYNCHRONOUS****HF100-010-001**

Rated power: 4 kW
 Max. speed: 30,000 rpm
 Nominal torque: 4 Nm
 Weight: 9 kg

**HF100-012-001**

Rated power: 4 kW
 Max. speed: 30,000 rpm
 Nominal torque: 4 Nm
 Weight: 10 kg

**HF125-002-001**

Rated power: 9 kW
 Max. speed: 24,000 rpm
 Nominal torque: 7.3 Nm
 Weight: 16 kg

**HF125-002-002**

Rated power: 12 kW
 Max. speed: 24,000 rpm
 Nominal torque: 9 Nm
 Weight: 16 kg

**HF150-003-003**

Rated power: 14.5 kW
 Max. speed: 26,000 rpm
 Nominal torque: 14.7 Nm
 Weight: 35 kg

**HF150-004-003**

Rated power: 14.5 kW
 Max. speed: 24,000 rpm
 Nominal torque: 14.7 Nm
 Weight: 39 kg

**HF150-009-001**

Rated power: 14.5 kW
 Max. speed: 26,000 rpm
 Nominal torque: 14.7 Nm
 Weight: 26 kg

**HF150-005-002**

Rated power: 20 kW
 Max. speed: 24,000 rpm
 Nominal torque: 14.3 Nm
 Weight: 36 kg

**HF205-006-001**

Rated power: 34 kW
 Max. speed: 14,000 rpm
 Nominal torque: 83.7 Nm
 Weight: 136 kg

SYNCHRONOUS**HF150-005-001**

Rated power: 20 kW
 Max. speed: 24,000 rpm
 Nominal torque: 18.5 Nm
 Weight: 36 kg

**HF205-006-002**

Rated power: 48 kW
 Max. speed: 6,000 rpm
 Nominal torque: 153 Nm
 Weight: 140 kg

AIR-COOLED**ASYNCHRONOUS****HF110-007-001**

Rated power: 4 kW
 Max. speed: 18,000 rpm
 Nominal torque: 3.8 Nm
 Weight: 15 kg

**HF145-001-001**

Rated power: 6 kW
 Max. speed: 24,000 rpm
 Nominal torque: 4.9 Nm
 Weight: 29 kg

**HF145-001-002**

Rated power: 7.5 kW
 Max. speed: 24,000 rpm
 Nominal torque: 6.1 Nm
 Weight: 30 kg

**HF145-001-003**

Rated power: 11.8 kW
 Max. speed: 24,000 rpm
 Nominal torque: 9.6 Nm
 Weight: 35 kg

**HF145-008-002**

Rated power: 7.5 kW
 Max. speed: 24,000 rpm
 Nominal torque: 6.1 Nm
 Weight: 19 kg

**HF145-011-001**

Rated power: 7.5 kW
 Max. speed: 24,000 rpm
 Nominal torque: 6.1 Nm
 Weight: 20 kg

ROBOT CHANGE UNIT**WWS100F-001/
WWS100L-001**

Connecting flange
 in accordance with
 EN ISO 9409-1:
 Energy transmission:

TK100
 Suitable for
 HF145-001
 4 kg

Total weight:

**WWS100F-002/
WWS100L-002**

Connecting flange
 in accordance with
 EN ISO 9409-1:
 Energy transmission:

TK100
 Suitable for
 HF125-002
 4.8 kg

Total weight:

MACHINE TOOLING TECHNOLOGY

ZERO-POINT CLAMPING SYSTEM

ZERO-POINT CLAMPING SYSTEM

In addition to a standard version reduced to the basic functions, which fulfills essential operations such as unlocking and a PLUS connection, there is also an advanced version with an extensive range of functions that are necessary for automated production, for example. Both variants feature positive locking via clamping segments that are specially adapted to the pin contour. This creates an extremely rigid

system that can absorb the highest forces with maximum repeat accuracy. The product range is extended by many different types of clamping plates, available in every size and various configurations. To increase the protection of the particular zero-point clamping system and to prevent any intrusion of dirt, there is an optional automatic seal that reliably protects the pin opening.

INCREASED PRODUCTIVITY

Without zero-point clamping system

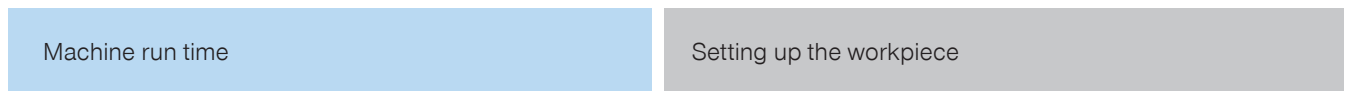

With zero-point clamping system

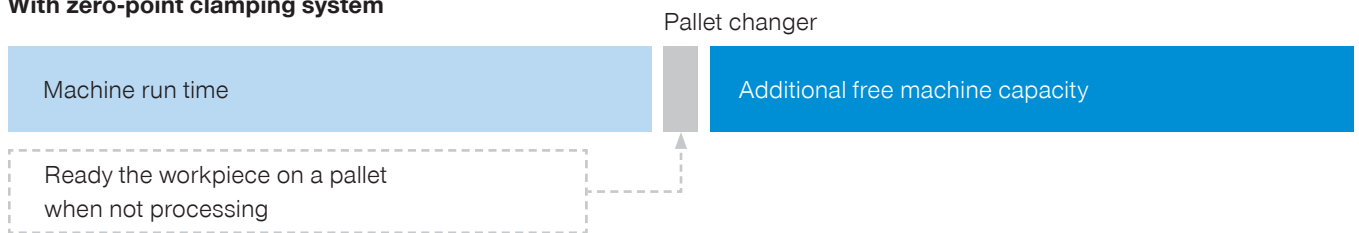

SPN ADVANCED

Pneumatic piston position sensing, positioning check and more – SPN Advanced stands for a wide variety of functions.

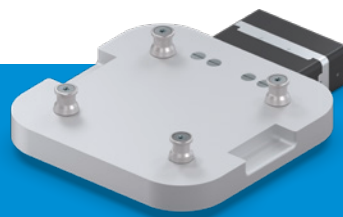

PALLET CHANGER SPP SERIES

Versatile options for machine loading due to a slim design and highest holding force.

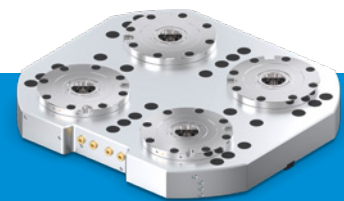

CLAMPING PLATES

Clamping plates with internal air distribution – with two, four or six integrated zero-point clamping systems for any installation size.

ZERO-POINT CLAMPING SYSTEM

ADVANCED



SPN062AD

Operating pressure:	4 bar - 7 bar
Clamping force:	1 kN - 2 kN
Clamping force with PLUS connection:	2.5 kN - 5 kN
Piston position sensing/ Positioning check:	Yes



SPN112AD

Operating pressure:	4 bar - 7 bar
Clamping force:	4 kN - 6 kN
Clamping force with PLUS connection:	10 kN - 15 kN
Piston position sensing/ Positioning check:	Yes



SPN138AD

Operating pressure:	4 bar - 7 bar
Clamping force:	12 kN - 18 kN
Clamping force with PLUS connection:	24 kN - 36 kN
Piston position sensing/ Positioning check:	Yes

STANDARD



SPN062SD

Operating pressure:	4 bar - 7 bar
Clamping force:	1 kN - 2 kN
Clamping force with PLUS connection:	2.5 kN - 5 kN
Piston position sensing/ Positioning check:	No



SPN112SD

Operating pressure:	4 bar - 7 bar
Clamping force:	4 kN - 6 kN
Clamping force with PLUS connection:	10 kN - 15 kN
Piston position sensing/ Positioning check:	No



SPN138SD

Operating pressure:	4 bar - 7 bar
Clamping force:	12 kN - 18 kN
Clamping force with PLUS connection:	24 kN - 36 kN
Piston position sensing/ Positioning check:	No

SPP SERIES

OUR EXPERTISE - YOUR ADVANTAGES

The SPP pallet changer with a variety of options

Whether it's handling components in portals, on robots or as a supplement to the tool changer with limited installation space and force.

Slim design - Maximum utilization

The combination of a slim and low profile design enable both close-proximity pallet loading on the machine table and maximum usage of the machine space.

High clamping force - Secure handling

An extremely rigid system - highest holding force and torques as well as a highly precise connection between the robot and the clamping plate.

PALLET CHANGER

PNEUMATIC



SPP138-B

Operating pressure:	4.5 bar - 7 bar
Max. pallet weight:	300 kg
Blow-out function / Piston position sensing:	Yes

CLAMPING PLATES

PNEUMATIC



SPN062P2, SPN112P2, SPN138P2

Operating pressure:	4 bar - 7 bar
Version:	Standard / Advanced
Max. holding force:	2x M8 2x M10 / M12 2x M12 / M16

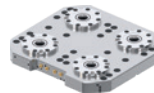

SPN062P4, SPN112P4, SPN138P4

Operating pressure:	4 bar - 7 bar
Version:	Standard / Advanced
Max. holding force:	4x M8 4x M10 / M12 4x M12 / M16

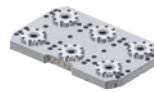

SPN062P6, SPN112P6, SPN138P6

Operating pressure:	4 bar - 7 bar
Version:	Standard / Advanced
Max. holding force:	6x M8 6x M10 / M12 6x M12 / M16

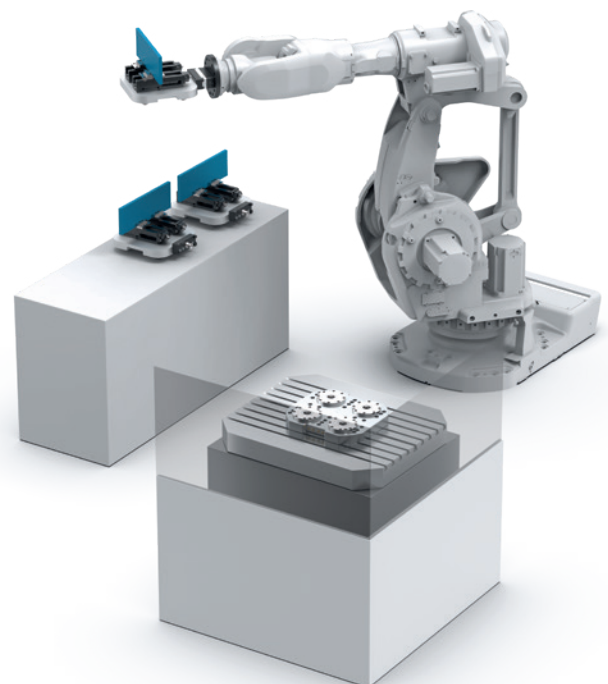

MACHINE TOOLING TECHNOLOGY

TRANSPORT SYSTEMS

TRANSPORT SYSTEMS

With their modular transport system for workpieces, the Zimmer Group combines the functions for transport, processing and quality assurance. Depending on the requirements profile, the actual transport route can be enhanced by a flexible arrangement of loading robots, measuring and plausibility stations, machining robots, converters or assembly stations.

The workpiece can be positioned anywhere along the cycle. The high flexibility results from the reconfigurability of the overall system, which allows nearly any number of shuttles, as well as independently acting function units.

OUR EXPERTISE – YOUR ADVANTAGES

Scalable

The transport and handling system allows nearly any number of shuttles in the cycle.

Flexibility

Smaller workpieces can either be conveyed as individual transport units or one large workpiece of several units as a master-slave assembly.

Reduced energy consumption

The integrated 48 V battery intermediate circuit buffer reduces the load current peaks approx. 85% and the system's energy consumption by more than 8%.

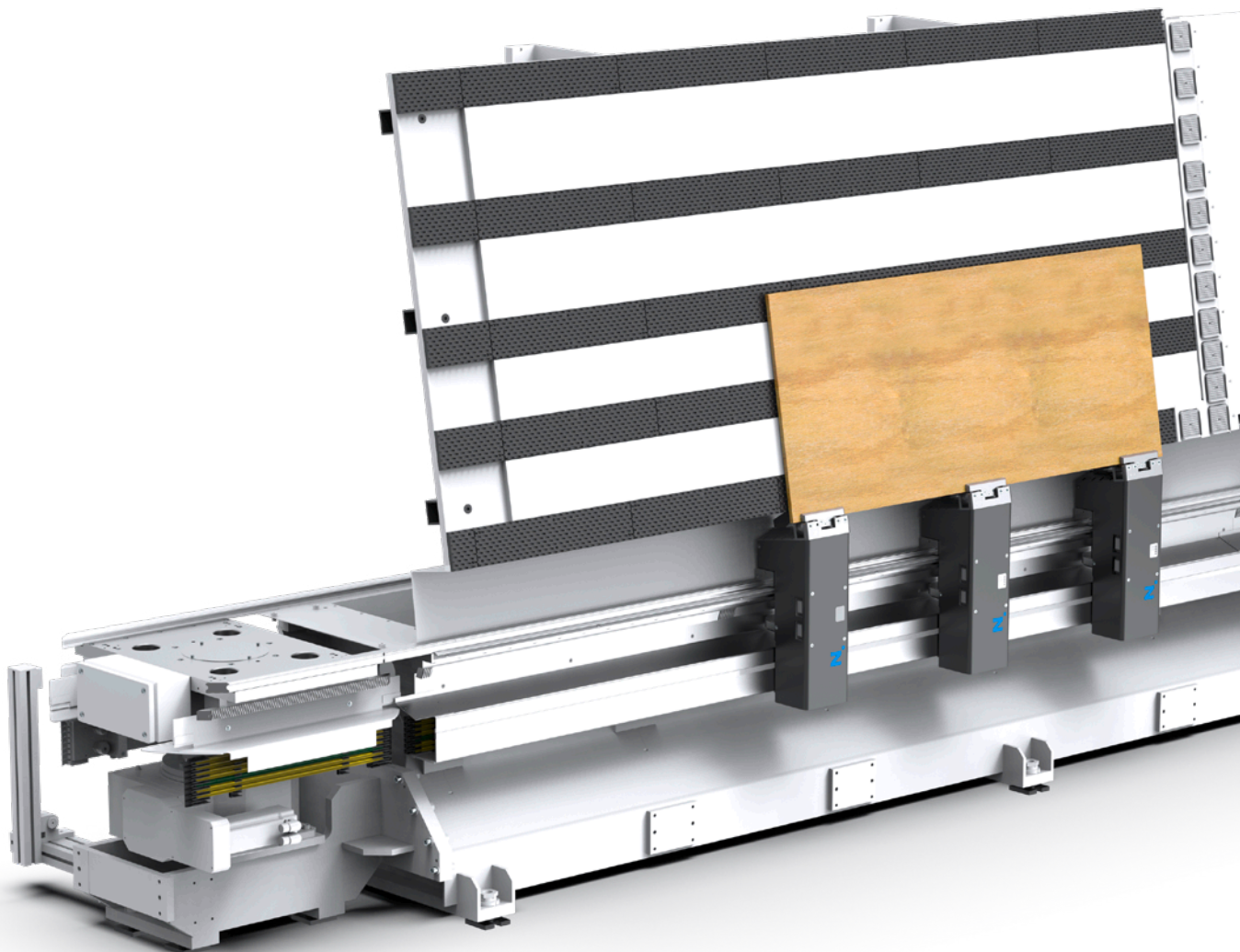

MACHINE TOOLING TECHNOLOGY

COMPLEX COMPONENTS

FLEXIBILITY WITHOUT LIMITS

The Zimmer Group offers innovative, application-optimized end-of-arm products for the increasing use of robot technology in the processing of wood, wood-like and composite materials. The flexibility knows no bounds: We manufacture products for implementing a wide variety of functions for machining modules and drilling units with rigid and extendable spindles and multi-functional units.

We focus on the highest level of scalability and productivity and rely on the latest development technologies and simulation methods such as the digital twin to design complete manufacturing and assembly cells.

WOODWORKING

With more than 25 years of experience, the Zimmer Group is one of the most innovative companies when it comes to groundbreaking wood machining solutions. No matter whether it's in the manufacturing of complex components or modular end-of-arm products for implementing a wide range of functions on the machining module, drilling unit or multi-functional units.

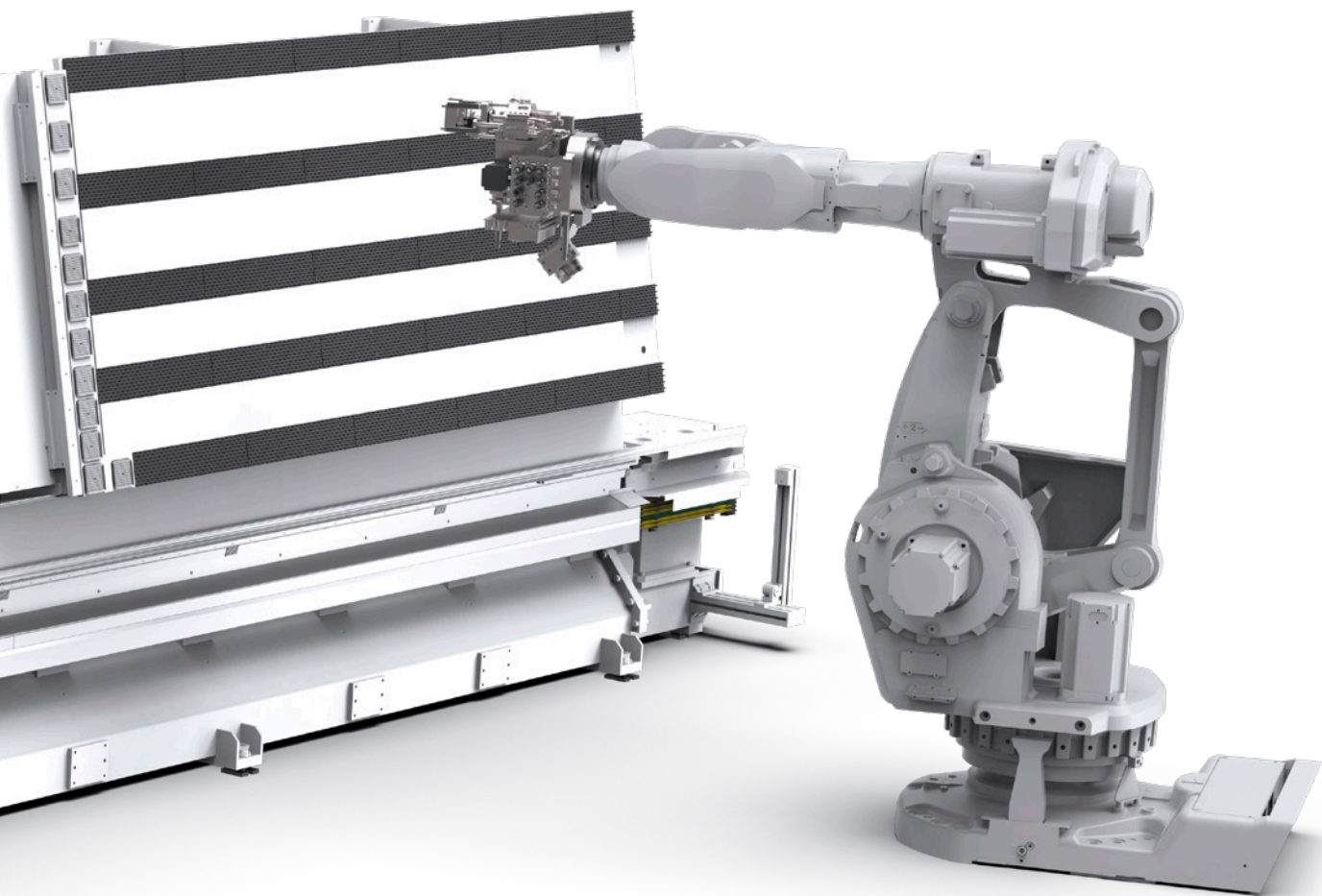

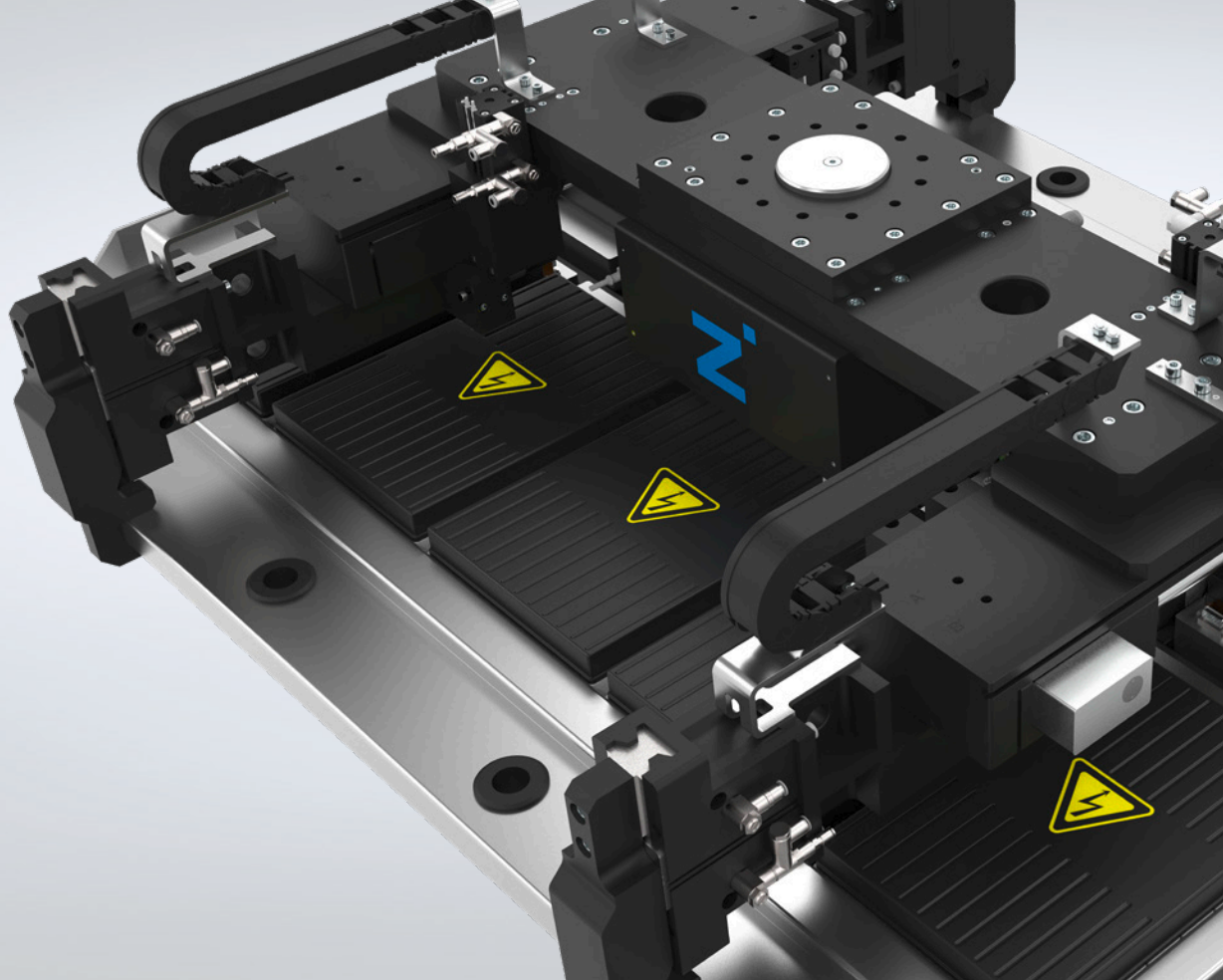

Universally applicable gripper system for battery packs from the e-mobility sector with a handling weight of up to 600 kg.

SYSTEM TECHNOLOGY BUNDLED KNOW-HOW

PARTNER OF INDUSTRY

Zimmer Group is one of the leading specialists in the area of systems solutions worldwide. We offer you sophisticated system solutions for almost every task, in virtually all industries and applications. It doesn't matter if it is a simple gripper and handling solutions or a complex system solution. With our many years of experience, we are very familiar with the requirements of modern production systems, whether in mechanical engineering, the automotive and supplier industries, foundries or in the electronics, plastics or the consumer goods sectors. Zimmer Group system solutions allow us to equip any make of robot optimally and significantly increase the functionality and efficiency of your robots.

The extensive expert solutions of our system technology department, with their experienced team of project engi-

neers, designers and manufacturers, has been valued by our customers for 30 years. Our systems are the result of a close collaboration with end customers and integrators built on trust. Zimmer Group system technology has specially tailored production and installation areas with a high degree of vertical integration.

This means that we can guarantee flexible, quick implementation of your project at any time. Zimmer Group has traditionally worked for a series of core industries that have benefited from our extensive experience and recognized development expertise for decades. We would be happy to speak with you about specific applications in new growth industries. We are well equipped for the development of new concepts. Together, we will be able to find the right solutions.

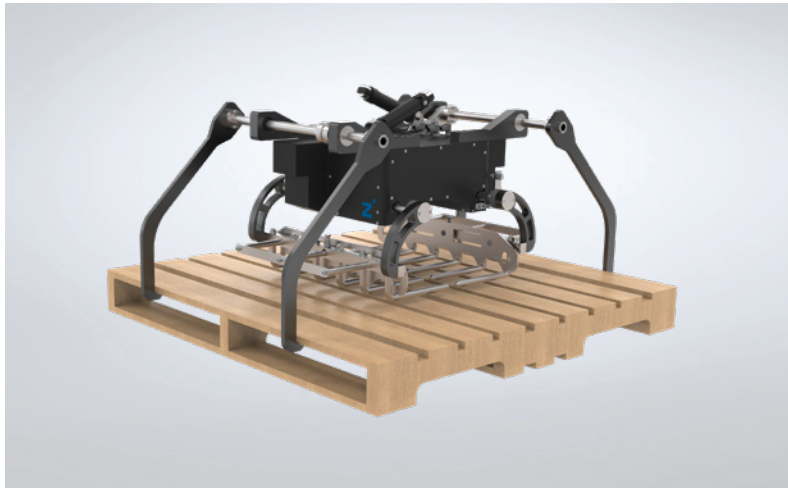
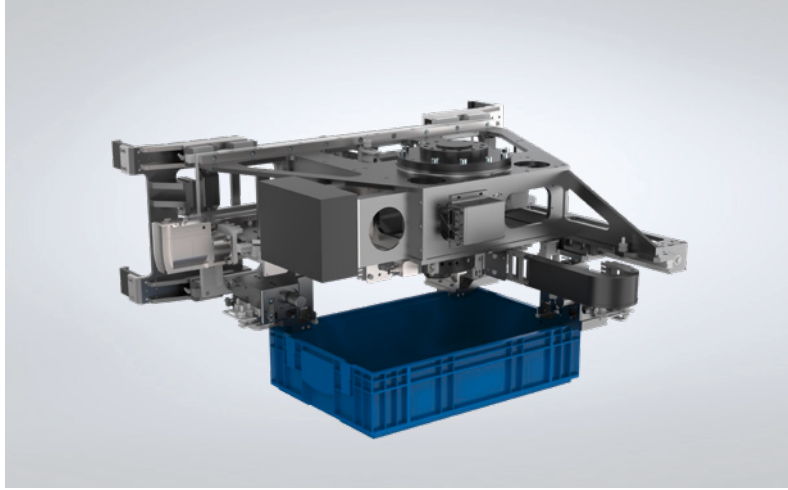
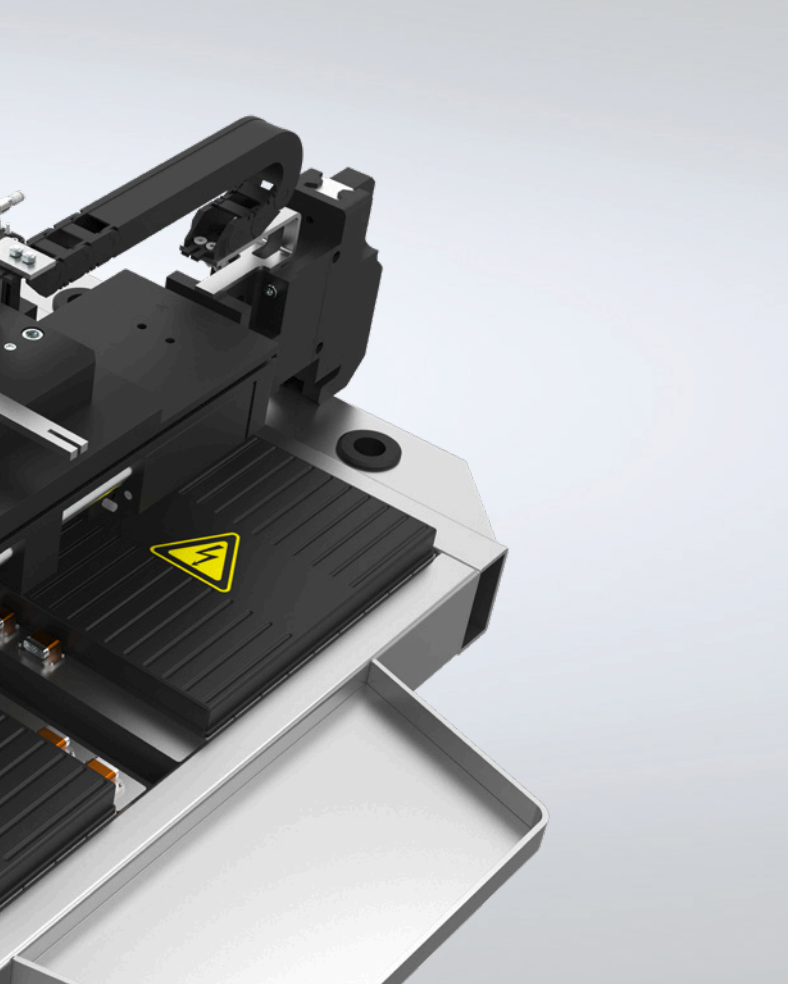

OVER 9000 SUCCESSFUL SYSTEM SOLUTIONS

Whatever market your company is based in, whether you are a local provider serving your home market or a global player focused on worldwide supply chains, and whatever your technical challenges may be: The Zimmer Group is your expert partner.



More examples can be found in our system showroom

Mobility

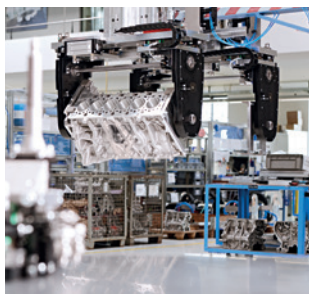

Automation

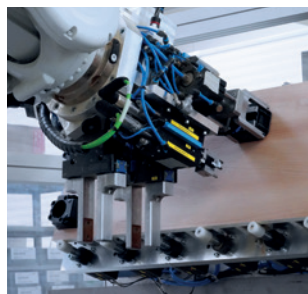

Consumer Goods



Logistics



PROCESS TECHNOLOGY

PROCESS TECHNOLOGIES

GEOMETRIC FREEDOM, MATERIAL FREEDOM, SERIES PRODUCTION

Metal, plastic or elastomer? We develop and manufacture your series production components optimized for their technical and cost-effectiveness characteristics. The highest quality, speed and reliability are our driving factors and always have the highest priority. Innovative ideas, individual solutions and decades of experience are the cornerstones of our success.

From intelligent system development, an optimal selection of materials and the associated production technologies to a cost-effective product – Zimmer Group is the reliable partner at your side thanks to its expert team with clever ideas and solutions. No challenge is too big.



MIM PROCESS

Thanks to the metal injection molding process from the Zimmer Group, there are no limits to the production of sophisticated workpieces. Series components made of metal with complex shapes often require production that involves many stages. The MIM process counteracts this and

makes it possible to manufacture nearly any shape of metal part through injection molding, combining the geometric freedom of plastic injection molding with the strength and wear properties of metals.

Feedstock

Metal powder, binder



Injection molding

Green part



Debinding

Brown part



Sintering

Metal part



The starting material consists of about 60% of the respective metal powder by volume and about 40% of a binder by volume, i.e. a blend of polymers and waxes. The homogeneous mixture of all of the components is of critical importance.

The binder portion is melted at a high temperature and the highly viscous mass of metal powder and binder is then pressed into the injection mold. The workpieces created from the metal powder and binder are called the "green part."

The majority of the binder is removed from the green parts. The remaining binder is vaporized out of the component at a temperature between 400 °C and 900 °C. The metal particles bind by forming what are known as sintering necks, giving the component sufficient stability.

The parts are condensed at high temperatures, usually above 1,000 °C. The respective temperature profile in the sinter furnace heavily depends on the material and the component geometry. This process step has to be carefully adjusted for each component geometry and each material.

MATERIAL CHARACTERISTICS

▶ Low-alloyed steels						
Material No.		sintered		hardened		Properties
AISI	DIN	Tensile strength N/mm ²	Hardness HV	Tensile strength N/mm ²	Hardness HV	
FN02		260	85 (45HRB)		600 (55 HRC)	
4605		415	110 (62 HRB)	1100	490 - 590 (48 - 55 HRC)	High strength Fatigue strength Surface hardness and excellent surface quality
FN08		380	120 (69 HRB)			
FN0805		700	150 (79 HRB)	1300	300 - 510 (30 - 50 HRC)	
100Cr6	1.3505	900	230 (97 HRB)		> 700 (60 HRC)	High wear resistance and hardness
8620	1.6523	650	190 (90 HRB)		650 - 800 (58 - 64 HRC)	High surface hardness in conjunction with toughness
42CrMo4	1.7225	700	130 (71 HRB)	1450	450 (45 HRC)	High strength and toughness, hardening by nitriding results in surface hardnesses of >600 HV10
4340	1.6565	700	130 (71 HRB)	1450	450 (45 HRC)	High strength and toughness

▶ Stainless steels						
Material No.		sintered		hardened		Properties
AISI	DIN	Tensile strength N/mm ²	Hardness HV	Tensile strength N/mm ²	Hardness HV	
17-4PH	1.4542	800	320 (32 HRC)		370 (38 HRC)	Martensitic, ferromagnetic stainless steel, high corrosion resistance, precipitation hardening is possible
316L	1.4404	450	120			Austenitic steel with excellent corrosion resistance, non-magnetic, moderate hardness, high ductility, excellent polishability
420W	1.4028	800	600 (55 HRC)	1560	730	High hardness, wear resistance, good corrosion resistance

▶ Tool steels						
Material No.		sintered		hardened		Properties
AISI	DIN	Tensile strength N/mm ²	Hardness HV	Tensile strength N/mm ²	Hardness HV	
M2	1.3343	1,200	520 (50 HRC)		820 (64 HRC)	Wear-resistant High-speed steel

▶ Titanium alloys						
Material No.		sintered		Properties		
AISI	DIN	Tensile strength N/mm ²				
Ti grade 2	3.7035	340	Biocompatible, good corrosion resistance, good chemical resistance, low density			
Ti6Al4V (grade 5)	3.7165	850	Biocompatible, good corrosion resistance, good chemical resistance, excellent mechanical properties, low density			

▶ Carbides						
Material No.		sintered		Properties		
AISI	DIN	Flexural strength N/mm ²	Compressive strength N/mm ²	Hardness HV		
WC0.8Co10		4,000	6,600	1,500	Excellent compressive and flexural strength, extremely high hardness	
WC0.8Co13.5		4,000		1,440	Excellent compressive and flexural strength, extremely high hardness	

PROCESS TECHNOLOGY

PROCESS TECHNOLOGIES

PLASTIC INJECTION MOLDING

When it comes to sophisticated plastic injection molding, the Zimmer Group is in its element with its interplay of development, engineering, tool construction, injection molding production and installation. All common plastics and even blends can be processed by using our bundled know-how and material variety. Mixtures of wood, plastics and also high-performance plastics are also used. As a supplier to the

automotive industry, furniture industry, construction industry, automation industry, machine engineering industry, medical technology and device technology, the Zimmer Group is your reliable partner for highly complex solutions. When it comes to maximum process optimization and integrated quality assurance, there are no technical limits. No challenge is too great for our wide range of technical implementation options



ELASTOMER TECHNOLOGY

Sophisticated workpiece production of the most complex geometries made from elastomers thanks to state-of-the-art production processes. The Zimmer Group provides everything that can be achieved in transfer molding (TM) or injection transfer molding processes (ITM) and processes a wide range of elastomers. No matter what dimensions,

quantities, workpiece dimensions or whether it's a special solution. The Zimmer Group stands for the highest flexibility, variability and level of optimization in combination with technically possible variations for hardness levels, coloring or improving the chemical, mechanical or thermal resistance. No demand is too big.







SERVICE

A STRONG PARTNER

TECHNICAL SUPPORT



As required, you can rely on the know-how and experience of our service technicians. Our innovative service products help run diagnostics and troubleshooting quickly and efficiently. Each error message can be systematically analyzed in a short time.

REPAIR SERVICE



For the repair and overhaul of your Zimmer products, count on the know-how of our specialists. Our repair service includes:

- ▶ Analysis of existing defects
- ▶ Repair by replacing the defective parts
- ▶ Complete overhauls

ON SITE SUPPORT



- ▶ Commissioning and installation support
- ▶ Product briefing and inspection
- ▶ Troubleshooting
- ▶ Exchanging components
- ▶ Repairs, modifications and extensions

SPARE PARTS



Original Zimmer Group spare parts and wear parts are perfectly harmonized to your systems and meet the most demanding quality standards. Our worldwide logistics network ensures that the required parts reach you within the shortest time possible.

The contents and data correspond to the status as of printing. Edition 10/2022.

This brochure was created with great care and all information has been checked for accuracy. However, we assume no liability for incorrect or incomplete information. Zimmer Group reserves the right to technical changes and improvements through constant ongoing development of products and services. All text, images, depictions and illustrations in this brochure are the property of Zimmer Group and protected by copyright. Any duplicating, editing, changing, translating, filming, processing or saving in electronic systems is prohibited without the consent of Zimmer Group.

ZIMMER GROUP – THE KNOW-HOW FACTORY

OUR KNOW-HOW FACTORY WORKS WITH ALL INDUSTRIES AND DELIVERS EVERYTHING FROM A SINGLE SOURCE. OUR PRODUCT RANGE IS FAR REACHING, BOTH IN ITS DEPTH AND ITS BREADTH.

DO YOU HAVE A DEVELOPMENT PROBLEM? WE'LL SOLVE IT! SET US A CHALLENGE IN RESEARCH AND DEVELOPMENT. COUNTLESS INNOVATIONS ORIGINATE FROM OUR COMPANY. WE ARE ENTHUSIASTIC ABOUT NEW PRODUCTS AND PRIDE OURSELVES ON OUR CORPORATE PIONEERING SPIRIT.

CONTACT – WORLDWIDE

With our current 13 global subsidiaries and partners in over 125 countries, we offer the excellent service of a technology leader. We look forward to hearing from you!



www.zimmer-group.com/en-us/contact

ZIMMER GROUP SYSTEM TECHNOLOGY – THE SPECIALISTS FOR CUSTOM SOLUTIONS

With over 30 years of development experience, the system technology develops special solutions for handling and automation.



www.zimmer-group.com/en-us/system-technology

HERE FOR YOU 24/7/365 – OUR VIRTUAL TRADE SHOW BOOTH

With impressive features such as an animated camera flight, clickable information hotspots and 3D models that can be rotated, we guarantee that you will be thrilled—virtually.



www.zimmer-group.com/en-us/expo

OUR NEW PRODUCTS

Zimmer Group is renowned as an innovator and for its pioneering spirit. Accordingly, each year we can offer new innovative and individual solutions. For current product highlights, refer to:



www.zimmer-group.com/en-us/innovations

HEADQUARTERS:

ZIMMER GROUP

Am Glockenloch 2
DE 77866 Rheinau
T +49 7844 9139-0
F +49 7844 9139-1199
info.de@zimmer-group.com
www.zimmer-group.com