

# COVAL

vacuum managers

## CVGC

CARBON Vacuum Grippers



**ADVANCED VACUUM SOLUTIONS**

## Carbon Vacuum Grippers

### General Information

With their innovative design, COVAL's **CVGC** carbon vacuum grippers correspond perfectly to the weight constraints, flexibility, and safety of collaborative robot applications.

Thanks to their innovative design, the **CVGC** series stands out for:

- A carbon structure, 2.5 times lighter than aluminum and offering mechanical strength 6 times greater.
- Soft material on the gripper edges, to protect both gripper and operator.
- A choice of gripping interfaces (suction cups or foam).
- Versions with or without an integrated vacuum generator.

All of this is integrated into a very compact and ultra-light design, easily incorporated on the robot and guaranteeing a fast setup.

Three standard sizes enable you to choose the **CVGC** best suited to your requirements and handle a variety of loads: corrugate, plastics, metal/glass plates, etc..



Industry-specific applications

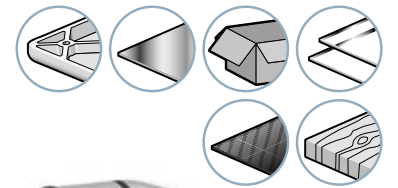

### Advantages

- Ultra-light and compact, due to their carbon design.
- Suitable for collaborative robot applications.
- Configurable to meet all applications.
- Fully integrated, allowing for easy and fast installation.
- Compatible with the vast majority of collaborative robots on the market.

### Characteristics

	Overall Dimensions L x W (mm)	Air drawn in <sup>(1)</sup> (SCFM)	Air consumed <sup>(1)</sup> (SCFM)	Capacity <sup>(2)</sup> (kg)	⚖️ <sup>(3)</sup> (kg)	
					Foam	Suction cups
CVGC240X120_	254x134	19.42	9.89	38	1.3	1.3
CVGC320X160_	334x174	19.42	9.89	68	1.5	1.8
CVGC350X250_	364x264	19.42	9.89	100	1.9	2.6

(1) Characteristics for vacuum gripper with integrated vacuum generator (CVGC\_M2\_).

(2) Indicative capacity at 85% vacuum for a gripper with foam interface covered 100% by the load, on a rigid and airtight surface.

(3) Maximum weight of each version (F2S and VSA33). Weight indicated for a vacuum gripper with vacuum generator (CVGC-M2) with A50 mounting. For a gripper with A63 mounting, add 150 g. For a gripper with A80 mounting, add 190 g. For a vacuum gripper without a vacuum generator (CVGC\_GO), subtract 300 g.

Plugins available for different robots

### Applications

The **CVGC** vacuum gripper provides a unique solution for the handling of products in various industrial sectors:

- Packaging
- Plastics
- Metal
- Glass
- Composite
- Wood



## Carbon Vacuum Grippers

### General Information



#### Ultra-light

Carbon design guarantees strength, rigidity, and an unmatched lightness.



#### External or integrated vacuum generation



#### 3 standard formats

240x120 mm  
320x160 mm  
350x250 mm



**Configurable gripping interface**  
depending on the products to be handled

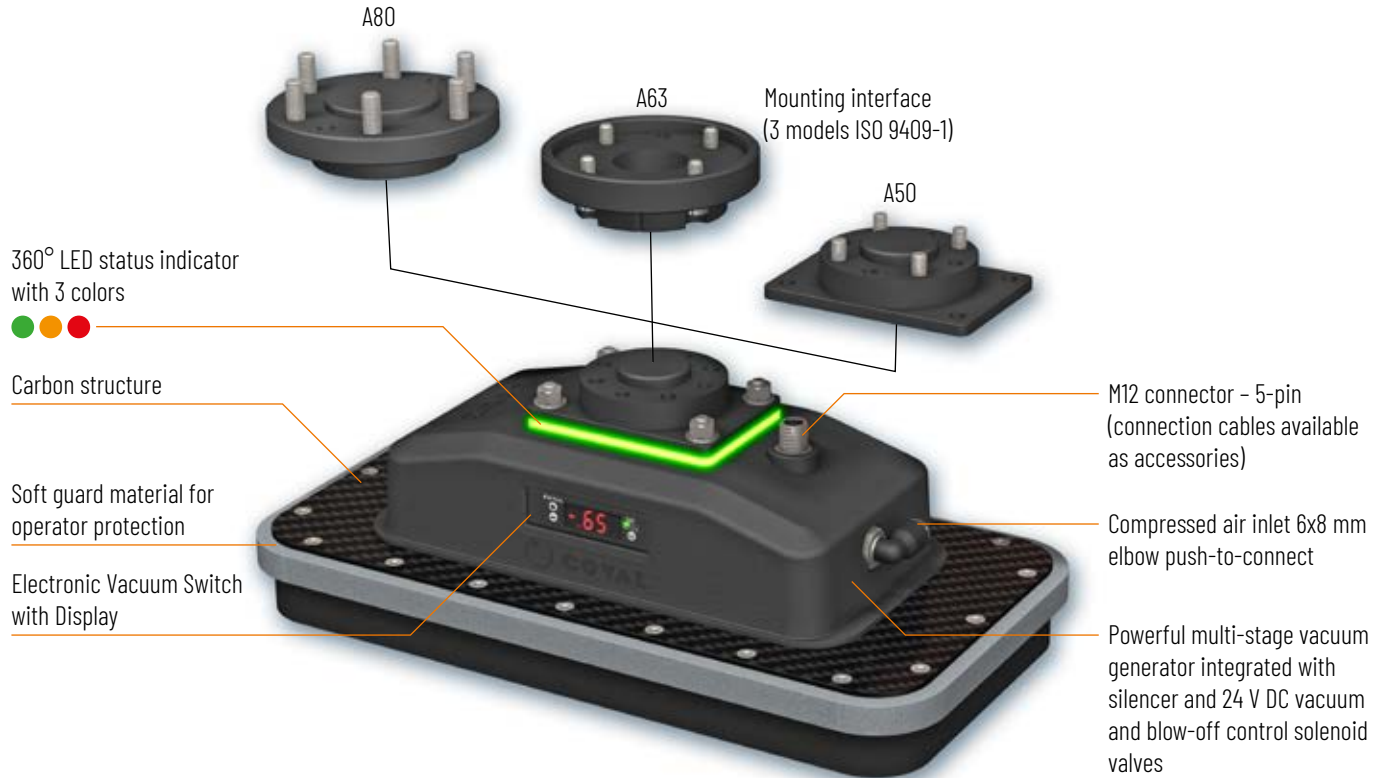

#### "Foam" Gripping Interfaces



CVGC\_\_F2S\_



CVGC\_\_F2L\_

#### "Suction cup" Gripping Interfaces



CVGC\_\_VSA25JI\_



CVGC\_\_VSA33JK\_

### CVGC\_\_GO\_: vacuum gripper without integrated vacuum generator

The **CVGC** vacuum grippers may also be used with an independent vacuum generator. Depending on the application, an external generator may be necessary (a blower, an electric vacuum pump, or a multi-stage CMS HD series generator.).

The **CVGC** series vacuum grippers, **GO** version, are equipped with a **VRU** series vacuum rotary union, ensuring vacuum supply to the gripper via an external source.

For more details, refer to the page "CVGC\_\_GO\_ Version Without Vacuum Generator".

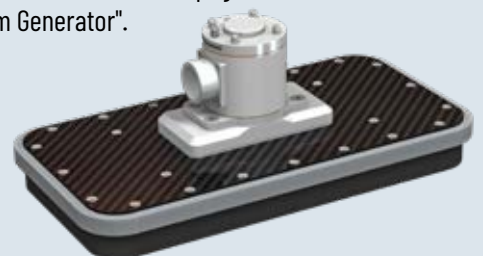



#### Flow Control Technology

The **CVGC** carbon vacuum grippers use **flow control nozzles** to limit the leakage rate from uncovered areas. This technology yields several advantages:

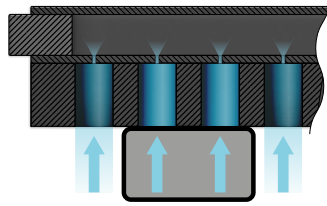

- Economic solution.
- Customizable calibration.
- Horizontal and vertical handling.

#### Vacuum Gripping Force

	Vacuum Level (%)	Gripping Force* (lbf)
CVGC240X120_	45	24.73
	75	40.47
CVGC320X160_	45	44.96
	75	74.19
CVGC350X250_	45	76.44
	75	127.02

\* Indicative force for a gripper with gripping interface covered 100% by the load, including a safety factor of 2 for horizontal handling, on a rigid and airtight surface.

#### Choice of Gripping Interface

The **CVGC** series offers an option between two gripping interface technologies for vacuum handling: foam or suction cups.

In order to optimize the performance of the **CVGC** series vacuum grippers for different applications, various spacings and diameters of the gripping points are available for each variant.

→ A wide range of options to meet your application needs.

##### "FOAM" Interface

- Handling of rigid products.
- Gripping textured or uneven surfaces.
- Flow control nozzles.
- 2 standard hole diameters (Ø12 mm and oblong 27x12 mm).



##### "SUCTION CUP" Interface

- Handling of flexible products.
- Wide range of cup options.
- Flow control nozzles in multiple diameters.
- 2 types of standard suction cups (Ø25 and Ø33 mm).



#### ISO 9409-1 Robot Mounting Interface

Version	Standard	Ø A (mm)	Ø B (mm)	Ø C (mm)	Ø D (mm)	Robot
A50	ISO 9409-1-50-4-M6	50	63	M6 (x4)	6	UR: UR3(e), UR5(e), UR10(e), UR16(e) OMRON/TECHMAN: TM5, TM12, TM14, TM16, TM20 DOOSAN: A0509, A0509S, A0912, A0912S, M0609, M0617, M1013, M1509, H2017, H2515 FANUC: CRX-5iA, CRX-10iA, CRX-10iA/L, CRX-20iA/L, CRX-25iA YASKAWA: HC10DTP, HC20DTP, HC30PL KASSOW ROBOTS: KR0810, KR1018, KR1205, KR1410, KR1805 JAKA: Zu 3, 3s, 5, 5s, 7, 7s, 12, 12s, 18, 18s, Ai 3, 5, 7, 12, 18, Pro 5, 12, 16
A63	ISO 9409-1-63-4-M6	63	80	M6 (x4)	6	YASKAWA: HC10, HC10DT
A80	ISO 9409-1-80-6-M8	80	100	M8 (x6)	8	YASKAWA: HC20DT UR: UR20, UR30

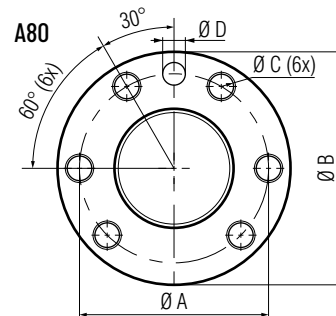
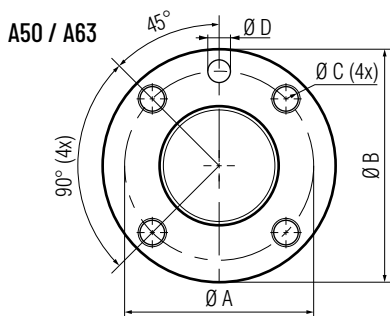



## Carbon Vacuum Grippers

### CVGC\_\_\_M2\_ Version with Vacuum Generator



The **CVGC** carbon vacuum gripper **M2** version with integrated vacuum generator, is a plug-and-play solution specifically designed to perfectly adapt to all models of collaborative robots. Ultra-compact, these grippers integrate all the necessary functions under a protective cover for optimal use.

With their innovative design and ease of installation, the **CVGC** carbon vacuum gripper **M2** version offers unmatched performance and reliability for your robotic applications.

360° LED status indicator with 3 colors

- Blinking: Vacuum Command
- Fixed: Object Gripped
- Blinking: Blow-off Command
- Blinking: Vacuum Command + Blow-off Command = Fault
- Fixed: Object Lost! Risk of part loss

Protective cover

integrating a high-performance through-type silencer.

Integrated vacuum switch with display (PSA100C):

- 1 x "gripped product" switching output 24 V DC NO or NC, PNP/NPN (125 mA max)
- Display in bar
- Keypad programming
- Output 1 visualization: green LED

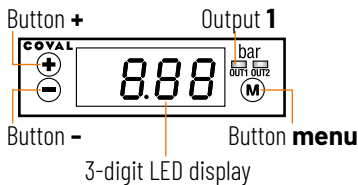

M12 connector - 5-pin (connection cables available as accessories)

Compressed air inlet 6x8 mm elbow push-to-connect

Integrated vacuum generator: Powerful multi-stage mini vacuum pump (CMSM90X30\_) with 24 V DC vacuum and blow-off control solenoid valves.



## Electrical Connections

One M12 5-pin male connector

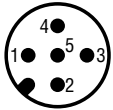

- |   |   |
|---|---|
| 1 | +24 V DC permanent  |
| 2 | 24 V DC suction command <sup>(1)</sup>                      |
| 3 | 0 V - GND   |
| 4 | "Gripped product" switching output 24 V DC PNP/NPN NO or NC |
| 5 | 24 V DC blow-off command                                    |

<sup>(1)</sup> 24 V DC suction command, depending on version:  
 - S: 24 V DC vacuum control  
 - V: 24 V DC vacuum off command

## Vacuum Control: 2 Solutions

The CVGC carbon vacuum grippers, CVGC\_M2 versions, integrating a controlled multi-stage vacuum pump, offer 2 choices for vacuum control.

**Model CVGC\_M2S\_:** vacuum pump with **NC** vacuum control and **NC** blow-off control. In the event of power failure, vacuum is no longer generated. In the event of compressed air failure, the vacuum is no longer maintained.

- NC blow-off and vacuum control: solenoid valves.

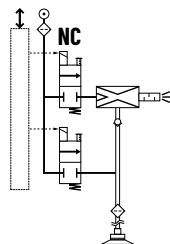

**Model CVGC\_M2V\_:** vacuum pump with **NO** vacuum control and **NC** blow-off control. In the event of power failure, vacuum is still generated: object is held in place → fail-safe.

In the event of compressed air failure, the vacuum is no longer maintained.

- NO vacuum control solenoid valve.
- NC blow-off control solenoid valve.

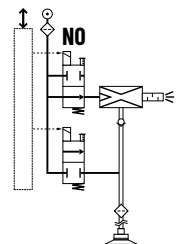

## Carbon Vacuum Grippers

### CVGC\_\_\_GO\_ Version Without Vacuum Generator



The **CVGC** carbon vacuum grippers may also be used with an independent vacuum generator. Depending on the application, an external generator may be necessary (a blower, an electric vacuum pump, or a multi-stage CMS HD series generator.).

The **CVGC** carbon vacuum gripper **GO** version are equipped with a **VRU** series vacuum rotary union, ensuring vacuum supply to the

gripper via an external source. The VRU's robust and lightweight design provides a direct connection between the robot and the gripper, while also allowing an external vacuum supply to the gripper.

Its continuous rotation system avoids coiling of the hose and eliminates force constraints when used with collaborative robots.

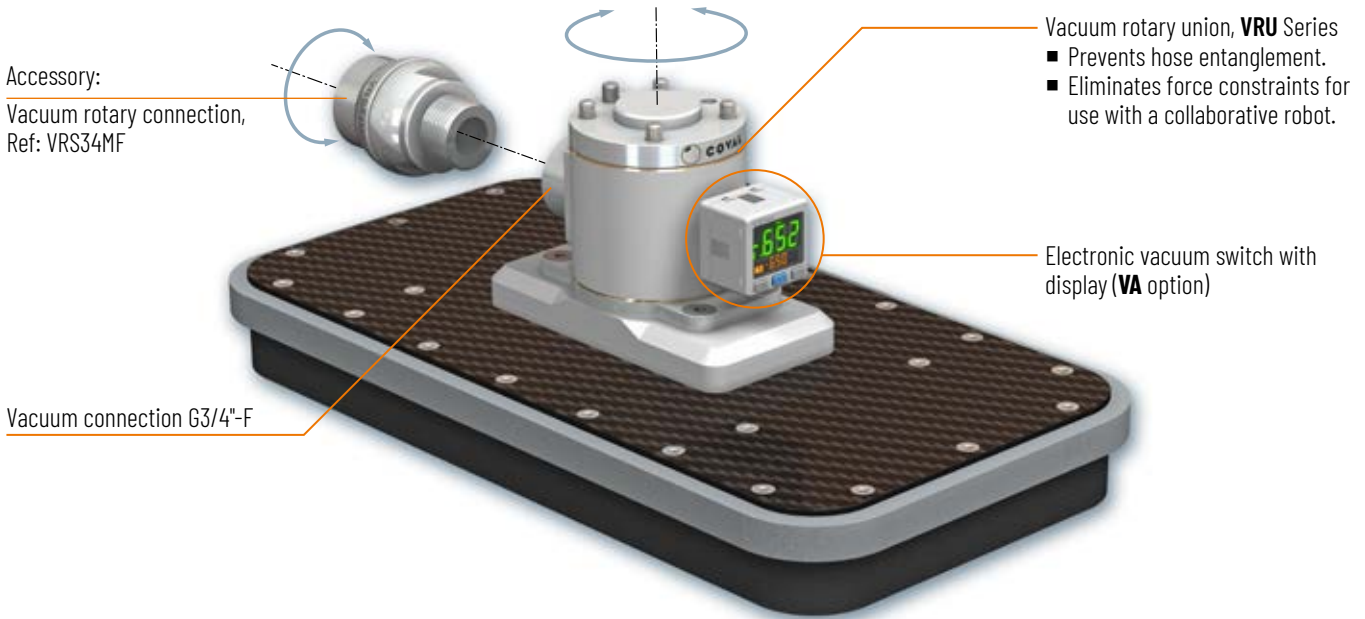

### Vacuum switch option (VA)

The vacuum grippers without a vacuum generator (CVGC\_**GO**\_ version) can be equipped with an electronic vacuum switch with display, ref. PSD100CPNP.

#### Main Characteristics

- Power supply voltage: 12 to 24 V DC  $\pm 10\%$ .
- Current consumption:  $\leq 40$  mA (without load).
- 1 PNP digital output 24 V DC, NO or NC (125 mA max.).
- 1 analog output (1-5V).
- 3-color digital LCD display, easy readability.
- 6 pressure units available (kPa, bar, psi, inHg, mmHg, kgf/cm<sup>2</sup>).
- M8 Connector - 4-pin (cable length 150 mm)

#### Panel Description

- 1 2-color main display
- 2 Pressure unit display section
- 3 Lock indicator
- 4 Setting mode (sub-display section)
- 5 Output 1 indicator
- 6 Button ▲
- 7 Setting button
- 8 Button ▼

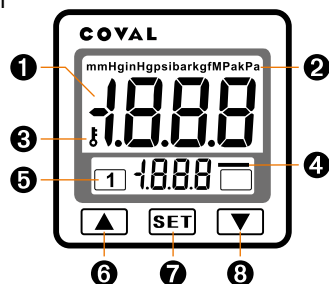

### Accessory: Vacuum rotary connection, Ref: VRS34MF

The **VRS** Series Vacuum Rotary Connection, with its robust and lightweight design, provides an in line rotary connection for vacuum supplies. Its continuous rotation system avoids coiling of the hose and eliminates force constraints when used with collaborative robots.



- Flow Rate: 52.97 SCFM
- Through bore  $\varnothing$ : 16 mm
- Maximum speed: 40 tr/min
- Connection: G3/4"-M/F
- Weight: 135g
- Materials: Aluminum - NBR Nitrile - Steel
- Temperature range: from  $-10^{\circ}\text{C}$  to  $+50^{\circ}\text{C}$  ( $14^{\circ}\text{F}$  to  $122^{\circ}\text{F}$ )

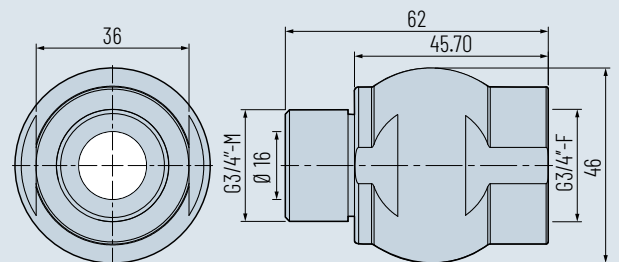





#### CVGC with integrated vacuum generator: CVGC\_\_\_\_\_M2\_

**CVGC 320x160 D VSA25JI X H X M2 S VA \_\_\_\_\_ A50**



DIMENSIONS L x W	GENERATOR CONTROL	ISO 9409-1 ROBOT MOUNTING INTERFACE
240 x 120 mm <b>240x120</b>	NC/NC <b>S</b>	ISO 9409-1-50-4-M6 <b>A50</b>
320 x 160 mm <b>320x160</b>	NO/NC <b>V</b>	ISO 9409-1-63-4-M6 <b>A63</b>
350 x 250 mm <b>350x250</b>		ISO 9409-1-80-6-M8 <b>A80</b>



#### SUCTION CUP GRIPPING INTERFACES

CUP PATTERN LAYOUT	INTERFACES
Straight  <b>D VSA25JI</b> "medium" type interface 1.5 bellows suction cups Ø 25 mm in natural rubber with flow control nozzles.	
Straight  <b>D VSA33JK</b> "maxi" type interface 1.5 bellows suction cups Ø 33 mm in natural rubber with flow control nozzles.	

#### FOAM GRIPPING INTERFACES

HOLE PATTERN LAYOUT	INTERFACES
Staggered  <b>Q F2S</b> Foam "mini" type interface Holes Ø12 mm, EPDM (thickness 20 mm).	
Straight  <b>D F2L</b> Foam "maxi" type interface Oblong holes 27x12 mm, EPDM (thickness 20 mm).	



#### CVGC without integrated vacuum generator: CVGC\_\_\_\_\_GO\_

**CVGC 240x120 D VSA25JI X H X GO R VA \_\_\_\_\_ A50**



DIMENSIONS L x W	VACUUM LEVEL DISPLAY	ISO 9409-1 ROBOT MOUNTING INTERFACE
240 x 120 mm <b>240x120</b>	Without <b>VO</b>	ISO 9409-1-50-4-M6 <b>A50</b>
320 x 160 mm <b>320x160</b>	Vacuum switch with electronic display <b>VA</b>	ISO 9409-1-63-4-M6 <b>A63</b>
350 x 250 mm <b>350x250</b>		ISO 9409-1-80-6-M8 <b>A80</b>



#### SUCTION CUP GRIPPING INTERFACES

CUP PATTERN LAYOUT	INTERFACES
Straight  <b>D VSA25JI</b> "medium" type interface 1.5 bellows suction cups Ø 25 mm in natural rubber with flow control nozzles.	
Straight  <b>D VSA33JK</b> "maxi" type interface 1.5 bellows suction cups Ø 33 mm in natural rubber with flow control nozzles.	

#### FOAM GRIPPING INTERFACES

HOLE PATTERN LAYOUT	INTERFACES
Staggered  <b>Q F2S</b> Foam "mini" type interface Holes Ø12 mm, EPDM (thickness 20 mm).	
Straight  <b>D F2L</b> Foam "maxi" type interface Oblong holes 27x12 mm, EPDM (thickness 20 mm).	



#### CVGC\_\_GO without integrated vacuum generator

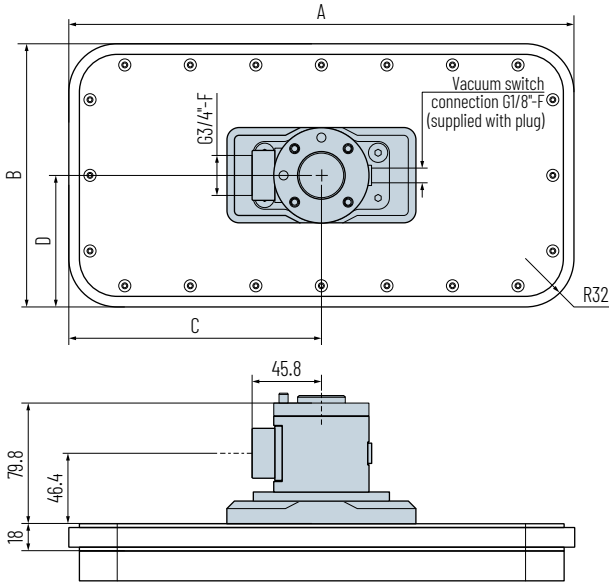

#### CVGC\_\_M2 with integrated vacuum generator

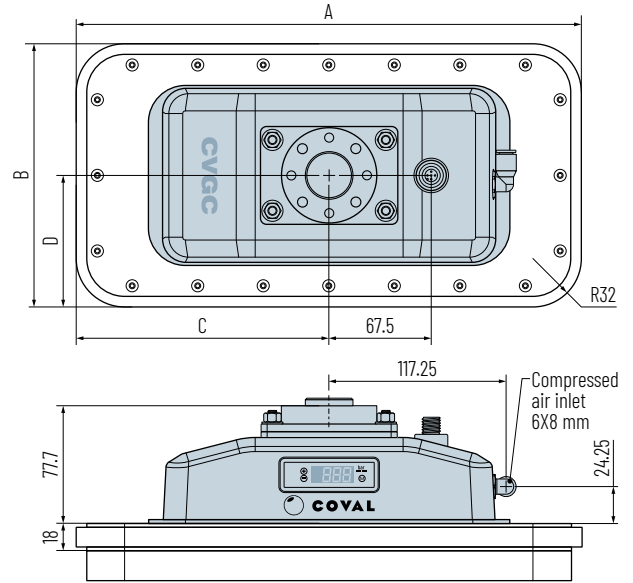

	A	B	C	D
CVGC240X120_	254	134	127	67
CVGC320X160_	334	174	167	87
CVGC350X250_	364	264	182	132

Note: all dimensions are in mm.

#### ISO 9409-1 Robot Mounting Interface

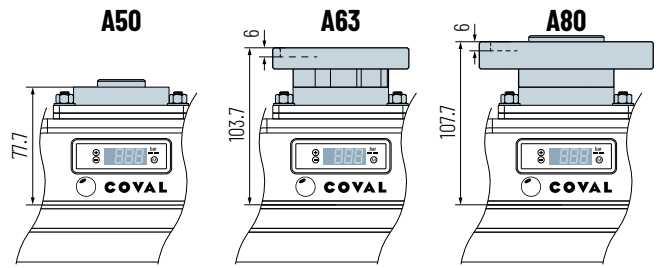
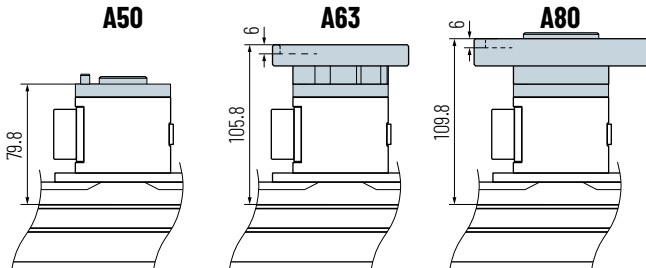

#### Gripping Interfaces

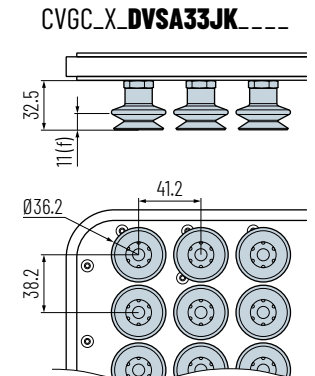
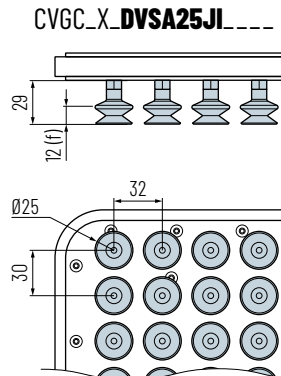
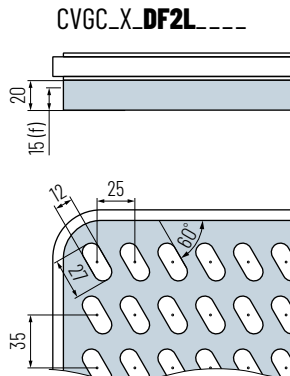
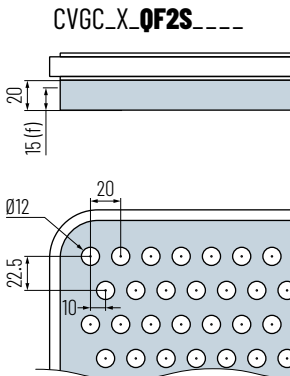

Number of holes/suction cups per interface type.

	F2S "mini" type interface	F2L "maxi" type interface	VSA25 "medium" type interface	VSA33 "maxi" type interface
CVGC240X120_	42	27	21	15
CVGC320X160_	87	48	45	28
CVGC350X250_	160	78	77	54



## Carbon Vacuum Grippers

### Accessories: Connection Cables



#### CCM12F5PM8F8PL015C1

- M12 - 5-pin female elbow
- M8 - 8-pin female elbow
- Cable length 150 mm (PUR)



 Universal Robots: CB3 UR3, UR5, UR10 + e-Series UR3e, UR5e, UR10e, UR16e, UR20, UR30<sup>(1)</sup>

Fanuc: CRX-5iA, CRX-10iA, CRX-10iA/L, CRX-20iA/L, CRX-25iA  
Yaskawa: HC10DT, HC10DTP, HC10DTP IP67, HC10SDTP, HC20DT, HC20DTP, HC30PL  
Kassow Robots: GEN1 & 2 KR0810, KR1018, KR1205, KR1410, KR1805

(!) UR's M8 connector will change in 09/2024 for new cobots and requires a UR tool cable adapter to ensure compatibility between the robot I/O and the gripper.

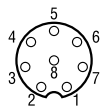

- |   |  |
|---|--|
| 1 | NC   |
| 2 | NC   |
| 3 | NC   |
| 4 | "Gripped product" switching output<br>24 V DC PNP/NPN NO or NC |
| 5 | +24 V DC permanent   |
| 6 | 24 V DC PNP/NPN blow-off command                               |
| 7 | 24 V DC PNP/NPN suction command                                |
| 8 | 0 V - GND  |

NC: not connected.

#### CCM12F5PM8M8PL015C2

- M12 - 5-pin female elbow
- M8 - 8-pin male elbow
- Cable length 150 mm (PUR)



 Omron/Techman: TM5, TM12, TM14, TM16, TM20

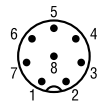

- |   |  |
|---|--|
| 1 | +24 V DC permanent   |
| 2 | "Gripped product" switching output<br>24 V DC PNP/NPN NO or NC |
| 3 | NC   |
| 4 | NC   |
| 5 | 24 V DC PNP/NPN suction command                                |
| 6 | 24 V DC PNP/NPN blow-off command                               |
| 7 | NC   |
| 8 | 0 V - GND  |

NC: not connected.

#### CCM12F5PM8M8PL015C3

- M12 - 5-pin female elbow
- M8 - 8-pin male elbow
- Cable length 150 mm (PUR)



 Doosan Robotics: A0509\*, A0509S\*, A0912\*, A0912S\*, M0609, M0617, M1013, M1509, H2017, H2515

\* Robots manufactured since 1/21/2021

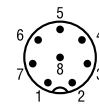

- |   |  |
|---|--|
| 1 | "Gripped product" switching output<br>24 V DC PNP/NPN NO or NC |
| 2 | 24 V DC PNP/NPN suction command                                |
| 3 | 24 V DC PNP/NPN blow-off command                               |
| 4 | NC   |
| 5 | +24 V DC permanent   |
| 6 | NC   |
| 7 | NC   |
| 8 | 0 V - GND  |

NC: not connected.

#### CCM125PL2 / CCM125PL5

- M12 - 5-pin female elbow
- 5-wire output
- Length 2 m (CCM125PL2) (PUR)
- Length 5 m (CCM125PL5) (PUR)



 Fanuc: CR-4, CR-7, CR-7 A/L, CR-14 A/L  
Yaskawa: HC10  
+ any application requiring cables to be routed outside the robot arm.  
+ any robot whose housing connection does not match with connection cables.



- |   |   |
|---|---|
| 1 | Brown: +24 V DC permanent   |
| 2 | White: 24 V DC PNP/NPN suction command                                |
| 3 | Blue: 0 V - GND   |
| 4 | Black: "Gripped product" switching output<br>24 V DC PNP/NPN NO or NC |
| 5 | Grey: 24 V DC PNP/NPN blow-off command                                |

#### CCM12F5PM8M8PL015C6

- M12 - 5-pin female elbow
- M8 - 8-pin male elbow
- Cable length 150 mm (PUR)



 JAKA: Zu 3, 3s, 5, 5s, 7, 7s, 12, 12s, 18, 18s  
Ai 3, 5, 7, 12, 18  
Pro 5, 12, 16

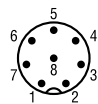

- |   |  |
|---|--|
| 1 | +24 V DC permanent   |
| 2 | "Gripped product" switching output<br>24 V DC PNP/NPN NO or NC |
| 3 | NC   |
| 4 | 24 V DC PNP/NPN suction command                                |
| 5 | 24 V DC PNP/NPN blow-off command                               |
| 6 | NC   |
| 7 | NC   |
| 8 | 0 V - GND  |

NC: not connected.

#### CCM12F5PM8M8PL015C7

- M12 - 5-pin female elbow
- M8 - 8-pin male elbow
- Cable length 150 mm (PUR)



 Universal Robots: e-Series UR3e, UR5e, UR10e, UR16e, UR20, UR30

(!) UR's M8 connector will change in 09/2024 for new cobots; this cable ensures compatibility between the robot I/O and the gripper.

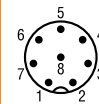

- |   |  |
|---|--|
| 1 | NC   |
| 2 | NC   |
| 3 | 24 V DC PNP/NPN suction command                                |
| 4 | 24 V DC PNP/NPN blow-off command                               |
| 5 | +24 V DC permanent   |
| 6 | "Gripped product" switching output<br>24 V DC PNP/NPN NO or NC |
| 7 | NC   |
| 8 | 0 V - GND  |

NC: not connected.



#### General Characteristics

- Operating temperature: from 0°C to 50°C (32°F to 122°F)
- Materials:
  - Gripper: carbon, brass, stainless steel, high-density EPDM foam
  - Foam gripping interface: EPDM
  - Suction cup gripping interface: NR, aluminum, steel

#### Characteristics of grippers with integrated vacuum generator, CVGC\_M2\_

- Supply: non-lubricated air, filtered to 5 microns, according to standard ISO 8573-1:2010 [3:4:4]
- Operating pressure: from 2 to 7 bar
- Optimal dynamic pressure: 5.5 bar
- Pressure Connection: 6X8 mm elbow quick connector - G1/4", with 200 µm filter screen
- Multi-stage Mini Vacuum Pump CMSM90X30\_: Equipped with a removable 200 µm vacuum filter screen
- Max Vacuum: 80%
- Air Suction Flow Rate: 19.42 SCFM
- Air Consumption: 9.89 SCFM
- Noise Level: 72 dB (at 50% vacuum, at optimal pressure)
- Protection Rating: IP40
- Max Operating Frequency: 2 Hz
- M12-5 pin connector

#### Materials:

- Cover: Brass, stainless steel, felt, aluminum, PMMA, PETP, PA
- Vacuum generator CMS-M for CVGC\_M2\_:
  - Base Body: PA GF, brass, NBR, PU
  - Valve Body: PA 6 glass fiber reinforced
  - Vacuum Connection Flange: PETP
  - Internal Pump Parts: Brass, aluminum
  - Internal Valve Block Parts: Brass, aluminum, steel, NBR, PU, FKM
  - Screws: Zinc-plated steel
  - Seals and Membrane: NBR, PU

#### Integrated Electronics:

- Power Supply: 24 V DC (regulated ± 10%)
- Inputs and Outputs: Protected against polarity reversal and overcurrent
- Vacuum Control: 24 V DC PNP/NPN
- Blow-off Control: 24 V DC PNP/NPN
- Idle consumption / without command: 35 mA
- Consumption during part gripping (no load): 150 mA
- Maximum peak consumption: 500 mA
- Input/Output Switching Type: Configurable as PNP or NPN

#### Integrated Vacuum Switch:

- Compatible Fluids: All non-corrosive, filtered, non-lubricated gases
- Power Supply: 24 V DC ± 10%
- Current Consumption: <60 mA
- 1 x Switching Output "gripped product": 24 V DC NO or NC, PNP/NPN (125 mA max)
- Output 1 Visualization: Green LED
- Keypad Programming
- Display in bar
- EMC Industrial Standard: Class B
- Display Resolution: 1%

- Setting Resolution: 1%
- Setting Range: 0.10 ~ -1.00 bar
- Measuring Range: 0.00 ~ -1.00 bar
- Allowable Overpressure: 3 bar

#### Indicator: 360° LED status visualization:

- Blinking green LED: Vacuum Command
- Fixed green LED: Object Gripped (threshold factory set at -0.65 bar)
- Blinking orange LED: Blow-off Command
- Blinking red LED: Vacuum Command + Blow-off Command = Fault
- Fixed red LED: Object Lost ! Risk of part loss

#### Plugins available for download on our website:

<https://doc.coval.com/CVGC>

#### Characteristics of grippers without vacuum generator, CVGC\_G0\_

- VRU34\_ Rotary Union:
  - Flow Rate: 52.97 SCFM
  - Endless Rotation
  - Vacuum Connection: G3/4"-F
  - Vacuum switch connection: G1/8"-F (supplied with plug)
- Materials: Steel, aluminum, POM, brass, nitrile NBR

#### Option VA - electronic vacuum switch with 3-color display (PSD100CPNP): CVGC\_\_\_\_\_VA\_

- Pressure rating range: 0 ~ -101.3 kPa
- Pressure setting range: 10 ~ -101.3 kPa
- Max. pressure: 300 kPa
- Fluid: Air, non-corrosive/non-flammable gas
- Hysteresis: adjustable
- Response time: ≤ 2.5ms, with anti-vibration function
- 7 segment LCD display: 2 color (red/green) main display, orange sub-display (refresh rate: 5 times/1 sec)
- Choice of pressure unit display: kPa, MPa, kgf/cm<sup>2</sup>, bar, psi, inHg, mmHg
- Power supply voltage: 12 to 24 V DC ±10%
- Current consumption: ≤ 40 mA (without load)
- Repeatability (switch output): ≤ ±0.2% F.S. ±1 digit
- Electrical connection: M8 - 4-pin (cable length 150 mm)
- Protection: IP40
- Ambient temperature range (operation): from 0°C to 50°C (32°F to 122°F)
- Material (enclosure): PA 6.6 20%GF

*Values are representative of the average characteristics of our products.*



#### CUSTOM VERSIONS



Your work may sometimes confront you with usage situations for which standard versions are not perfectly adapted.

COVAL can provide you with custom solutions based on your specifications.



We offer custom dimensions, integration of specific functions (e.g., multi-zone), and gripping interfaces based on the COVAL suction cup range.

This range offers a wide choice of shapes, diameters, and materials, effectively meeting all your needs.



#### Examples of customized CVGC carbon vacuum grippers.

##### CVGC260X200Z01VSA33JKXHXSP\_\_\_\_\_

CVGC vacuum gripper G0 version:

- Dimensions: 260x200 mm
- Carbon gripper shape: Adapted
- Suction Cups: VSA33NR with nozzle inserts
- Rotary Union: Offset VRU



##### CVGC600X400Z02VSA53JNXHXSP\_\_\_\_\_

CVGC vacuum gripper G0 version:

- Dimensions: 600x400 mm
- Suction Cups: VSA53 NR with nozzle inserts
- Multi-zone: 2 gripping zones and 2 independent "Vacuum" supply flanges
- 2 Electronic Vacuum Switches with Display: (VA option)

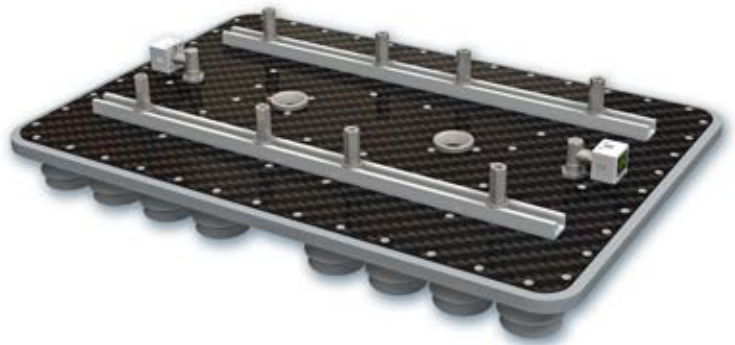

##### CVGC305X260Z01VSA43JNXHXSP\_\_\_\_\_

CVGC vacuum gripper with integrated generator:

- Integration of a Controlled Multi-stage Vacuum Pump: CMS HD series
- Suction Cups: VSA43 NR with nozzle inserts
- Vacuum Switch with Display



##### CVGC800X120Z01F2LXHXSP\_\_\_\_\_

CVGC vacuum gripper M2 version:

- Dimensions: 800x120 mm
- Foam Interface: "Maxi" type





**COVAL**  
vacuum managers

vacuum  
**components**



### A TECHNOLOGICAL PARTNER ON A GLOBAL SCALE

Located in the South of France, COVAL SAS designs, produces, and markets high-performance vacuum components and systems for industrial applications in all sectors worldwide.

An ISO 9001: V2015 certified company, COVAL innovates globally in vacuum handling. Our optimized components integrate intelligent and reliable functionalities, adapt to your industrial context, and safely improve your productivity.

With a strong spirit of innovation and technological advancements, the COVAL team is now recognized as an expert in developing reliable, economical, and productive custom solutions.

COVAL's references are found in major industrial sectors such as packaging, food processing, automotive, plastics, aerospace, and robotics, where vacuum handling is crucial for efficiency and productivity.

COVAL markets its products and services worldwide through its subsidiaries and authorized distributor network. Always attentive to its customers, COVAL supports the implementation of its solutions with a continuous and attentive relationship.

Visit the following section on our website:  
*contacts > commercial network* to view the latest up-to-date list.



**COVAL S.A.S.**  
Head Office



**COVAL INC.**



**COVAL IBERICA**



**COVAL GERMANY**



**COVAL ITALIA**



**COVAL CHINA**

Distributed by:



**COVAL VACUUM TECHNOLOGY INC.**  
901 Jones Franklin Road  
Suite 100  
Raleigh, NC 27606  
Phone : (919) 233-4855  
Fax : (919) 233-4854

[www.coval-inc.com](http://www.coval-inc.com)