

Quick Ship Chain Program



1m length chains



DISTRIBUTED BY:

Air-Oil Systems, Inc.

AUTOMATION SOLUTIONS

753 WAMBOLD ROAD SOUDERTON, PA 18964-2715
215.721.9595 800.333.5520 FAX 215.721.7666

www.airoil.com

murrplastik®

Simply Smart Systems





QUICK SHIP PROGRAM

Cable Drag Chain Systems

Murrplastik Cable Drag Chain Systems have proven their quality and longevity under extreme constant loads and environmental influences. Quick delivery and reasonable prices.

MP 18.1 Series Drag Chain

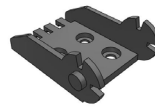

Length: 1 meter/30 links

Assembled 1-meter length Part Number	Inside Height	Inside Width	Outside Width	Radius	Male Bracket Part Number	Female Bracket Part Number	Separator Part Number
0181-01-015-028-0-0-990	18	15	28	28	018100004900	018100004800	018200009000
0181-01-015-048-0-0-990	18	15	28	48	018100004900	018100004800	018200009000
0181-01-025-028-0-0-990	18	25	38	28	018100005300	018100005200	018200009000
0181-01-025-048-0-0-990	18	25	38	48	018100005300	018100005200	018200009000
0181-01-025-078-0-0-990	18	25	38	78	018100005300	018100005200	018200009000
0181-01-037-028-0-0-990	18	37	50	28	018100005500	018100005400	018200009000
0181-01-037-048-0-0-990	18	37	50	48	018100005500	018100005400	018200009000
0181-01-037-078-0-0-990	18	37	50	78	018100005500	018100005400	018200009000
0181-01-050-028-0-0-990	18	50	63	28	018100005700	018100005600	018200009000
0181-01-050-048-0-0-990	18	50	63	48	018100005700	018100005600	018200009000
0181-01-050-078-0-0-990	18	50	63	78	018100005700	018100005600	018200009000
0181-01-070-048-0-0-990	18	70	83	48	018100005900	018100005800	018200009000
0181-01-070-078-0-0-990	18	70	83	78	018100005900	018100005800	018200009000

*bracket images may vary slightly from actual products

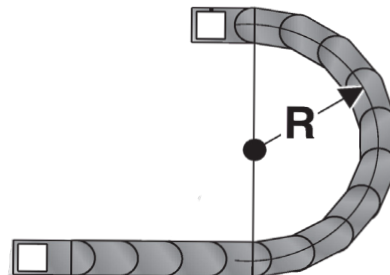
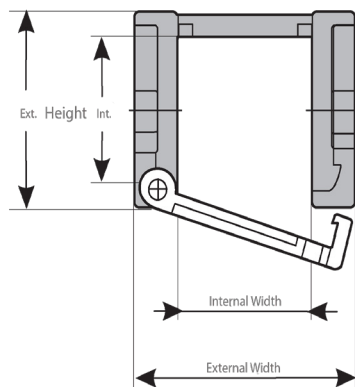



MP 3000 Series Drag Chain



Length: 1 meter/22 links

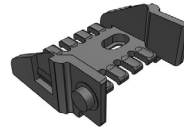

Male Bracket

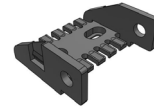

Female Bracket



Separator

Assembled 1-meter length Part Number	Inside Height	Inside Width	Outside Width	Radius	Part Number	Part Number	Part Number
0300-02-037-050-0-0-990	26	37	55	50	030000008300	030000008200	030000009200
0300-02-037-095-0-0-990	26	37	55	95	030000008300	030000008200	030000009200
0300-02-037-150-0-0-990	26	37	55	150	030000008300	030000008200	030000009200
0300-02-056-050-0-0-990	26	56	74	50	030000007700	030000007600	030000009200
0300-02-056-095-0-0-990	26	56	74	95	030000007700	030000007600	030000009200
0300-02-056-150-0-0-990	26	56	74	150	030000007700	030000007600	030000009200
0300-02-076-050-0-0-990	26	76	94	50	030000007900	030000007800	030000009200
0300-02-076-095-0-0-990	26	76	94	95	030000007900	030000007800	030000009200
0300-02-076-150-0-0-990	26	76	94	150	030000007900	030000007800	030000009200

*bracket images may vary slightly from actual products

MP 35.1 Series Drag Chain



Length: 1 meter/ 18 links



Male Bracket



Female Bracket



Strain Relief



Separator

Assembled 1-meter length Part Number	Inside Height	Inside Width	Outside Width	Radius	Part Number	Part Number	Part Number	Part Number
0351-01-050-075-0-2-1008	35	50	68	75	0350005051	0350005050	0351050010	035000009400
0351-01-050-100-0-2-1008	35	50	68	100	0350005051	0350005050	0351050010	035000009400
0351-01-050-150-0-2-1008	35	50	68	150	0350005051	0350005050	0351050010	035000009400
0351-01-075-075-0-2-1008	35	75	93	75	0350007551	0350007550	0351075010	035000009400
0351-01-075-100-0-2-1008	35	75	93	100	0350007551	0350007550	0351075010	035000009400
0351-01-075-150-0-2-1008	35	75	93	150	0350007551	0350007550	0351075010	035000009400
0351-01-100-075-0-2-1008	35	100	118	75	0350010051	0350010050	0351100010	035000009400
0351-01-100-100-0-2-1008	35	100	118	100	0350010051	0350010050	0351100010	035000009400
0351-01-100-150-0-2-1008	35	100	118	150	0350010051	0350010050	0351100010	035000009400

*bracket images may vary slightly from actual products



MP 45.1 Series Drag Chain

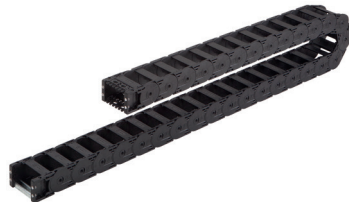

Length: 1 meter/15 links

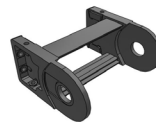
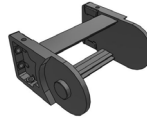

Male Bracket

Female Bracket

Strain Relief

Separator

Assembled 1-meter length Part Number	Inside Height	Inside Width	Outside Width	Radius	Male Bracket Part Number	Female Bracket Part Number	Strain Relief Part Number	Separator Part Number
0451-01-075-125-0-2-1005	45	75	95	125	0450007551	0450007550	0451075010	045000009200
0451-01-075-150-0-2-1005	45	75	95	150	0450007551	0450007550	0451075010	045000009200
0451-01-075-200-0-2-1005	45	75	95	200	0450007551	0450007550	0451075010	045000009200
0451-01-100-125-0-2-1005	45	100	120	125	0450010051	0450010050	0451100010	045000009200
0451-01-100-150-0-2-1005	45	100	120	150	0450010051	0450010050	0451100010	045000009200
0451-01-100-200-0-2-1005	45	100	120	200	0450010051	0450010050	0451100010	045000009200
0451-01-150-125-0-2-1005	45	150	170	125	0450015051	0450015050	0451150010	045000009200
0451-01-150-150-0-2-1005	45	150	170	150	0450015051	0450015050	0451150010	045000009200
0451-01-150-200-0-2-1005	45	150	170	200	0450015051	0450015050	0451150010	045000009200

*bracket images may vary slightly from actual products

DISTRIBUTED BY:



Air-Oil Systems, Inc.

AUTOMATION SOLUTIONS

753 WAMBOLD ROAD SOUDERTON, PA 18964-2715
215.721.9595 800.333.5520 FAX 215.721.7666

www.airoil.com

murrplastik

Simply Smart Systems

